

# HEALTH AND PHYSICAL EDUCATION

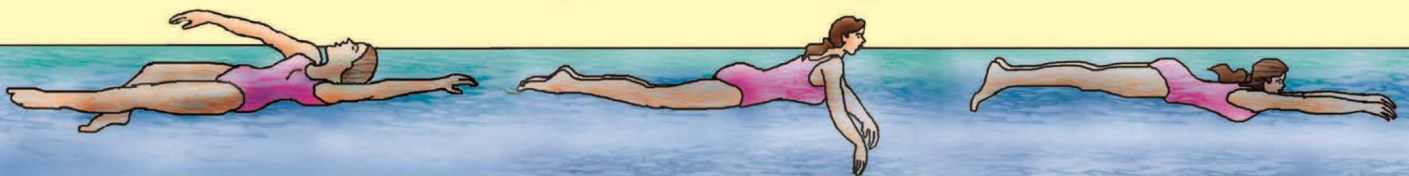
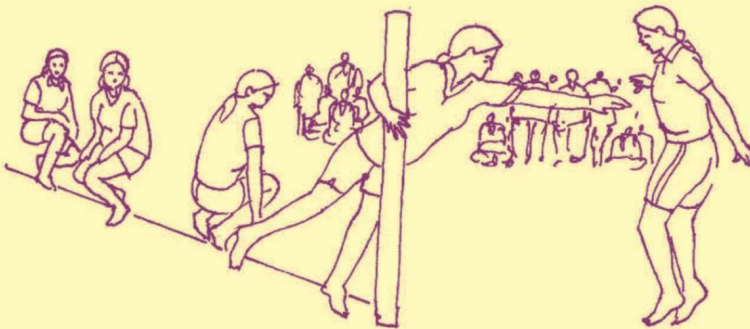
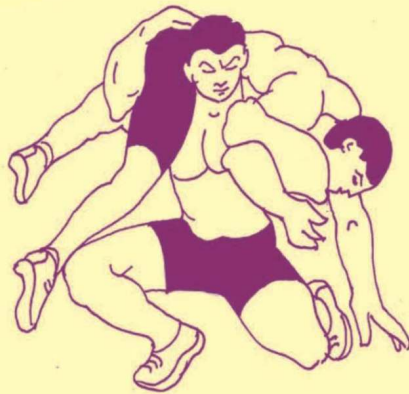
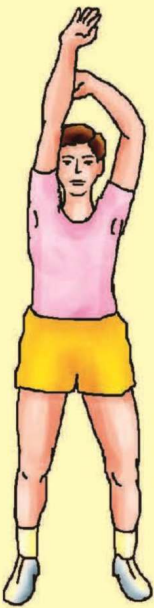

**Textbook for Class IX**

# Health and Physical Education

Textbook for Class IX



13149

विद्यया ऽ मृतमश्नुते



एन सी ई आर टी  
NCERT

राष्ट्रीय शैक्षिक अनुसंधान और प्रशिक्षण परिषद्  
NATIONAL COUNCIL OF EDUCATIONAL RESEARCH AND TRAINING

ISBN 978-93-5007-819-8

**First Edition**

November 2016 Kartika 1938

**Reprinted**

August 2019 Shravana 1941

January 2020 Magha 1941

**PD 5T RPS**

© National Council of Educational  
Research and Training, 2016

₹ 200.00

Printed on 80 GSM paper with NCERT  
watermark

Published at the Publication Division  
by the Secretary, National Council of  
Educational Research and Training,  
Sri Aurobindo Marg, New Delhi 110 016  
and printed at Eye Vision Printograph, 78,  
Mohkampur Industrial Complex, Phase-I,  
Delhi Road, Meerut - 250 002 (U.P.)

**ALL RIGHTS RESERVED**

- ❑ No part of this publication may be reproduced, stored in a retrieval system or transmitted, in any form or by any means, electronic, mechanical, photocopying, recording or otherwise without the prior permission of the publisher.
- ❑ This book is sold subject to the condition that it shall not, by way of trade, be lent, re-sold, hired out or otherwise disposed of without the publisher's consent, in any form of binding or cover other than that in which it is published.
- ❑ The correct price of this publication is the price printed on this page, Any revised price indicated by a rubber stamp or by a sticker or by any other means is incorrect and should be unacceptable.

**OFFICES OF THE PUBLICATION  
DIVISION, NCERT**

NCERT Campus  
Sri Aurobindo Marg  
New Delhi 110 016 Phone : 011-26562708

108, 100 Feet Road  
Hosdakere Halli Extension  
Banashankari III Stage  
Bengaluru 560 085 Phone : 080-26725740

Navjivan Trust Building  
P.O.Navjivan  
Ahmedabad 380 014 Phone : 079-27541446

CWC Campus  
Opp. Dhankal Bus Stop  
Panihati  
Kolkata 700 114 Phone : 033-25530454

CWC Complex  
Maligaon  
Guwahati 781 021 Phone : 0361-2674869

**Publication Team**

Head, Publication Division : Anup Kumar Rajput  
Chief Editor : Shveta Uppal  
Chief Production Officer : Arun Chitkara  
Chief Business Manager : Bibash Kumar Das  
Editor : Bijan Sutar  
Production Assistant : Sunil Kumar

**Cover**

D. K. Shende

**Illustrations**

Arvinder Chawla

# FOREWORD

Many factors like, physical, psychological, socio-economic and cultural influence our health, both in our day-to-day life and in the long run. Health of children is very important as they constitute a large percentage of our population. In this endeavour, school education plays an important role. Right to Education Act 2009 has very categorically focused on the role of school in holistic development and health of children in the age group of 6-14 years. Therefore, health and physical fitness needs to be looked into at different levels of schooling. Health and Physical Education (including Yoga) is an integral part of the school curriculum, towards an overall development of the child. With this view, the National Council of Educational Research and Training (NCERT) is in the process of developing textbooks on Health and Physical Education for Classes IX and X.

The present textbook – *Health and Physical Education* for Class IX, focuses on a holistic understanding of health highlighting importance of exercise, games and sports, nutrition and the environment. This book also provides a scope to discuss the psycho-social and mental health related issues of children and collective responsibilities for healthy community living. Given the interdisciplinary nature of this subject, cross references have also been mentioned.

Given the inter-related nature of the concepts covered in the area of Health and Physical Education, the presentation is made in a cohesive and integrated manner, rather adopting fragmentary approach. Experiential learning activities for acquiring skills for healthy living are made an integral part of the book.

NCERT appreciates the hard work done by the Textbook Development Committee. I am highly thankful to Professor Saroj Yadav, Dean (Academic) and Project Coordinator of National Population Education Project (NPEP) and Adolescence Education Programme (AEP) for her continuous effort to develop this material in the present form. Several experts and teachers contributed towards the finalisation of this book. We are grateful to them and their institutions.



As an organisation committed to systemic reform and continuous improvement in the quality of our products, NCERT welcomes comments and suggestions which will enable us to undertake further revision and refinement.

HRUSHIKESH SENAPATY

*Director*

National Council of Educational  
Research and Training

New Delhi  
*June, 2016*

© NCERT  
not to be republished

# TEXTBOOK DEVELOPMENT COMMITTEE

## MEMBERS

Bharati Sarkar, *Former Associate Professor*, Maitreyi College, Delhi University.

I.V Basavaraddi, *Director*, Morarji Desai National Institute of Yoga, 68, Ashoka Road, Near Gol Dak Khana, New Delhi.

Jaishri Acharya, *Reader*, Laxmibai National University of Physical Education, Shakti Nagar, Gwalior-474002 (MP).

Late Ajay Singh Ruhel, *Associate Professor*, DESS, NCERT, New Delhi.

Sagarika Bannerjee, *Dean and Head*, Department of Physical Education, Viswabharati University, Shantiniketan- 731235 (West Bengal).

Sima Saigal, *Assistant Professor*, NERIE Shillong, NCERT.

Swati Bhawe, *Executive Director*, Association of Adolescent and Child Care in India, Visiting Consultant Indraprastha Apollo Hospital, New Delhi

## MEMBER COORDINATOR

Saroj Yadav, *Dean Academic and Project Coordinator* of NPEP, AEP, NCERT, New Delhi.

# **THE CONSTITUTION OF INDIA**

## **PREAMBLE**

**WE, THE PEOPLE OF INDIA**, having solemnly resolved to constitute India into a <sup>1</sup>**[SOVEREIGN SOCIALIST SECULAR DEMOCRATIC REPUBLIC]** and to secure to all its citizens :

**JUSTICE**, social, economic and political;

**LIBERTY** of thought, expression, belief, faith and worship;

**EQUALITY** of status and of opportunity; and to promote among them all

**FRATERNITY** assuring the dignity of the individual and the <sup>2</sup>[unity and integrity of the Nation];

**IN OUR CONSTITUENT ASSEMBLY** this twenty-sixth day of November, 1949 do **HEREBY ADOPT, ENACT AND GIVE TO OURSELVES THIS CONSTITUTION.**

1. Subs. by the Constitution (Forty-second Amendment) Act, 1976, Sec.2, for "Sovereign Democratic Republic" (w.e.f. 3.1.1977)
2. Subs. by the Constitution (Forty-second Amendment) Act, 1976, Sec.2, for "Unity of the Nation" (w.e.f. 3.1.1977)

## ACKNOWLEDGEMENTS

The National Council of Educational Research and Training (NCERT) acknowledges the valuable contribution of the following individuals for reviewing and refining the manuscript of this book: A.K. Uppal, Mayur Vihar, Phase II, Pocket E, Delhi; Ajay Kumar Bansal, Sports Authority of India, New Delhi; Amita Gupta, *Freelance Editor*, Pushp Vihar, New Delhi; Ankur Yadav, *Assistant Professor*, Department of Communication, NIHFV, New Delhi; Asha Bansal, SPE Zone-4, Directorate of Education, District North, East Yamuna Vihar, Delhi; Ashok Kumar, MD, *Programme Officer*, Training Cell, IPP VIII Delhi Sector VII, Rohini; Bharti, MD, *Assistant Director* (Ayurveda), Central Council for Research in Ayurvedic Sciences, 61-65, Institutional Area, Opp. D-Block, Janakpuri, New Delhi; Devender Singh Yadav, *Senior Lecturer*, SCERT (DIET, DG), Delhi; Dhananjay Shaw, Indira Gandhi Institute of Physical Education, F-403, Green Valley Apartments, Sector-22, Dwarka, New Delhi; Gulab Singh Gahlot, *SPE*, Office of Deputy Director of Education South, New Delhi; Indu Mazumdar, *Professor*, Laxmibai National University of Physical Education, Shakti Nagar, Gwalior-474002; D.C. Jain, *Deputy Director General* (NCD), Directorate General of Health Services, Ministry of Health and Family Welfare, Nirman Bhawan, New Delhi; Indu Sardana, *Former TGT-Home Science*, Sarvodaya Kanya Vidyalaya, Malviya Nagar, New Delhi; Jogishwar Goswami, Amity School of Physical and Sport Sciences (ASPESS), Sector-125, Amity University, Noida, U.P.; Manju Jain, *Professor*, DEE, NCERT, New Delhi; Mukesh Kohli, *Associate Professor*, Physical Education, R.L.A College (Evening), Binito Juarez Marg, New Delhi; N.K. Jangira, *Professor* (Retd.), and Former Head, DTEE, NCERT, New Delhi; Meenakshi Pahuja, *Assistant Professor*, Physical Education, Lady Shri Ram College for Women, Lajpat Nagar, New Delhi; N.B. Shukla, *Professor*, Physical Education, Faculty of Arts, BHU, Varanasi; Poonam Khattar, *Associate Professor*, NIHFV, New Delhi; Raj Bala Dalal, *Assistant Director*, Physical Education, New Delhi; Ramesh Pal, *Professor*, Laxmibai National University of Physical Education, Sadhana Arya, D-II/354, Pandara Road, New

Delhi-3; Shakti Nagar, Gwalior-474002; Sudhir Kumar Sharma, *Associate Professor*, Department of Physical Education, Swarnim Gujarat Sports University, Sector-15, Gandhinagar; Sandeep Tiwari, *Associate Professor*, IGIPSS, University of Delhi, Delhi; Shamsher Singh Jung Bahadur, *Retired Professor*, Dean Faculty of Education, Department of Physical Education, CDL University, Sirsa; Sheela Kumari S, *Associate Professor*, Department of Physical Education, Gargi College, Siri Fort Road, New Delhi; Shivani Goswami, Retired from Mother's International School, Sri Aurobindo Marg, New Delhi; S. Gnaneswara Rao, RIE Bhubaneswar; Vikram Singh, *Assistant Director*, Phy. Edu., New Mehrauli Road, Jawaharlal Nehru University, New Delhi-67; W.D. Bhutia, DDG, Ministry of Health and Family Welfare, New Delhi.

We acknowledge with thanks the training material developed by Department of Sports for PYKKA, Ministry of Youth Affairs, Government of India. The material included in the chapter on individual and team game is heavily dependant on above materials.

The chapter on yoga is taken from the book *Yoga — a Healthy Way of Living* developed by NCERT for Secondary Stage.

We acknowledge with thanks for all the support given by Prof. Neeraja Rashmi, *Head DESS* for this textbook.

We acknowledge with thanks Shri R.N. Bhardwaj and Shri Naresh Kumar Yadav for editing this material.

We acknowledge the contribution of Arvinder Chawla for making illustrations for this textbook, *Junior Project Fellows* Jayvir Singh and Sana Rehman and the word processing team Geeta Dwivedi and Nitin Kumar Gupta.

The Council gratefully acknowledges the valuable suggestions received from the National Monitoring Committee in the development of the manuscript of this textbook.



## HOW TO USE THIS BOOK

Health is of concern to both the young and the old. Good health can be maintained by eating the right kind of food, living in a healthy environment and undertaking physical activities throughout life. This textbook is, therefore, of more importance for the growing young students. But then, how can both teachers and students make the best use of this book?

As a teacher you have to understand that this textbook is different from other subject textbooks in the sense that its contents need to be understood well and applied throughout life for one's own well being and that of others. Its use should not, therefore, be solely examination driven. Even a general discussion from time to time would be useful. Activities included in it, are of practical nature and enjoyable and you can make sure that concepts are clarified by involving students in experiential learning. Physical activities and exercises of all kinds have been given to ensure the development of fitness and questioning skills, including life skills.

You as a student can undertake activities, play games and do yoga as given in the book in a relaxed manner for healthy living. The textbook also contains abundant interesting **case studies** related to your age and concerns. Thought provoking incidents have been included at relevant places. **Think and answer** questions related to various dimensions of health and physical education have been added.

**We would welcome your feedback on this book in terms of** — How did you like this textbook? What are your experiences in organising or being a part of various activities? What were the difficulties faced by you? What changes would you like to see in the next version of this book? Do write to us on all these and all other matters related to this textbook. You could be a parent, a teacher, a student or just a casual reader. You can send your feedback on the form at the end of this book to the undersigned.

We sincerely hope you enjoy this book and learn more than it offers.

New Delhi  
June, 2016

PROFESSOR SAROJ YADAV  
*Dean (Academic)*  
National Council of Educational  
Research and Training

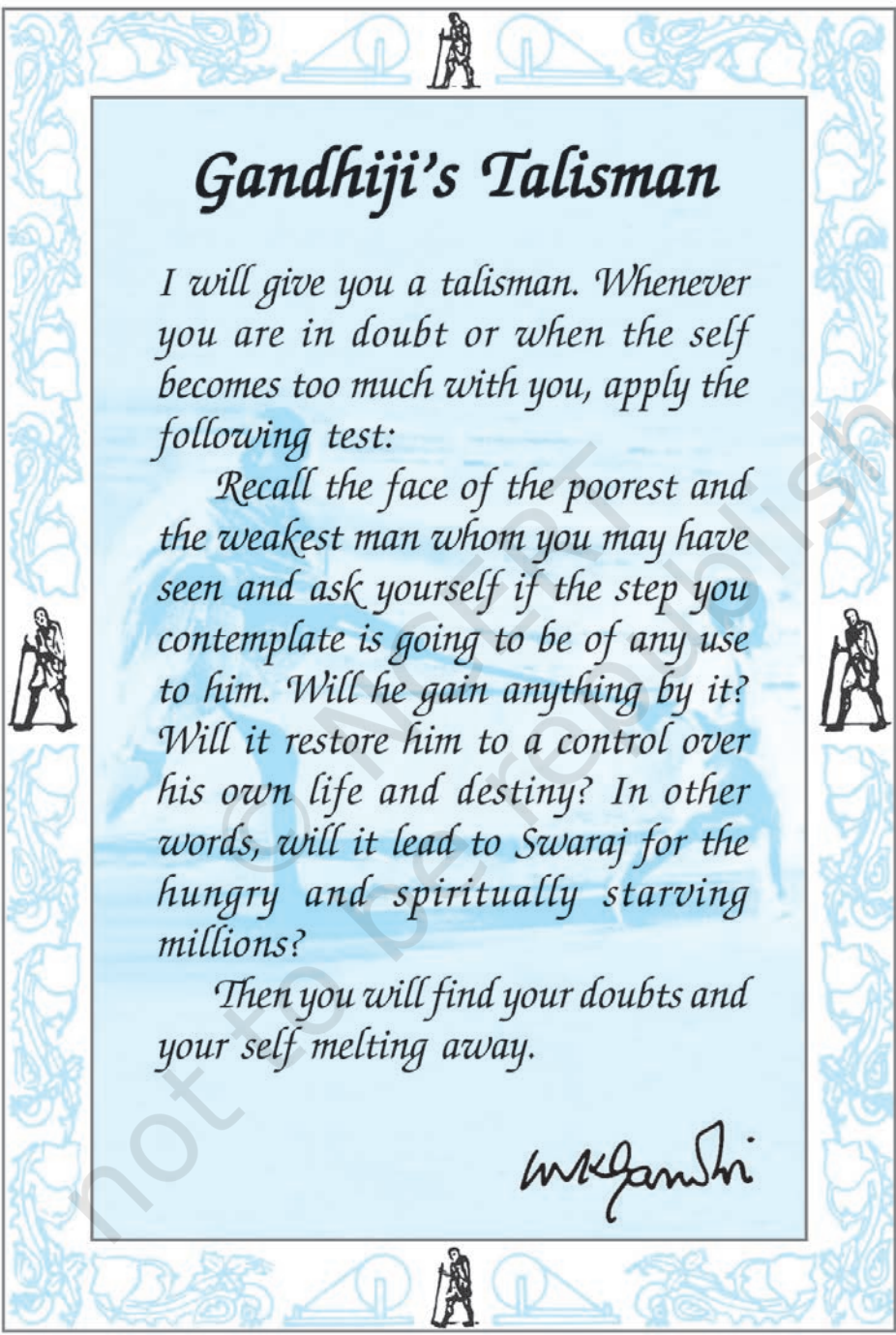

## Gandhiji's Talisman

*I will give you a talisman. Whenever you are in doubt or when the self becomes too much with you, apply the following test:*

*Recall the face of the poorest and the weakest man whom you may have seen and ask yourself if the step you contemplate is going to be of any use to him. Will he gain anything by it? Will it restore him to a control over his own life and destiny? In other words, will it lead to Swaraj for the hungry and spiritually starving millions?*

*Then you will find your doubts and your self melting away.*

*M.K. Gandhi*

<i>Foreword</i>		<i>iii</i>
<i>How to Use this book</i>		<i>ix</i>
Chapter 1	Health and Diseases	1-15
Chapter 2	Growing up with Confidence	16-29
Chapter 3	Physical Education	30-37
Chapter 4	Physical Fitness	38-45
Chapter 5	Sports Training	46-52
Chapter 6	Individual Sports	53-80
Chapter 7	Team Games	81-108
Chapter 8	Ethics in Sports	109-118
Chapter 9	Personality Development through Yoga	119-150
Chapter 10	Waste Management	151-160
Chapter 11	Diet for Healthy Living	161-176
Chapter 12	First Aid and Safety	177-184
Chapter 13	Social Health	185-193
Chapter 14	Adolescent Friendly Health Services	194-201
Appendix	Feedback Questionnaire	202-203

# CONTENTS



## CHILDREN'S BILL OF RIGHTS

*A child is every person under the age of 18 years. Parents have the primary responsibility for the upbringing and development of the child. The State shall respect and ensure the rights of the child.*

- I have the Right to express my views freely which should be taken seriously, and everyone has the Responsibility to listen to others. *(Article 12,13)*
- I have the Right to good health care, and everyone has the Responsibility to help others get basic health care and clean water. *(Article 24)*
- I have the Right to a good education, and everyone has the Responsibility to encourage all children to go to school. *(Article 28,29,23)*
- I have the Right to be loved and protected from harm and abuse, and everyone has the Responsibility to love and care for others. *(Article 19)*
- I have the Right to be included whatever my abilities, and everyone has the Responsibility to respect others for their differences. *(Article 23)*
- I have the Right to be proud of my heritage and beliefs, and everyone has the Responsibility to respect the culture and belief of others. *(Article 29,30)*
- I have the Right to a safe and comfortable home and everyone has the Responsibility to make sure all children have homes. *(Article 27)*
- I have the Right to make mistakes, and everyone has the Responsibility to accept we can learn from our mistakes. *(Article 28)*
- I have the Right to be well fed, and everyone has the Responsibility to prevent people from starving. *(Article 24)*
- I have the Right to a clean environment, and everyone has the Responsibility not to pollute it. *(Article 29)*
- I have the Right to live without violence (verbal, physical, emotional), and everyone has the Responsibility not to be violent to others. *(Article 28,37)*
- I have the Right to be protected from economic and sexual exploitation, and everyone has the Responsibility to ensure that no child is forced to work and is given a free and secure environment. *(Article 32,34)*

These rights and responsibilities are enshrined in the United Nations Convention on the Rights of the Child, 1989. It contains all the rights which children and young people have all over the world. The Government of India signed this document in 1992.

# Health and Diseases

## 1



13149CH01

### 1.1 INTRODUCTION

We normally relate the terms diseases and illness interchangeably in relation to health, even though these words do not mean the same. Health is the general condition of a person in respect to all aspects of life. It is also a level of functional and/or metabolic efficiency of an organism. The word metabolic is the adjective of the term metabolism which means the whole range of big chemical processes that occur within us or any living organism to produce energy and basic materials needed for important life processes. Diseases and illness adversely affect these processes. And thus health, diseases and illness are inter-related. However, health is not just being free from diseases, illness or injury. As defined by World Health Organisation (WHO), health is *“a state of complete physical, mental and social well-being and not merely an absence of disease or infirmity”*.

### 1.2 WHAT IS ILLNESS?

Let's now see how is illness different from that of disease? While illness and disease are at times used interchangeably, these in fact, are different from each other. Disease refers to a biomedically defined deviation from norms of body function or structure, whereas, illness is the experience of this deviation. It is a state of experience by the body when one or more of the control systems of the body are not functioning normally. Illness refers to a subjective distress feeling of a person, when one is sick or suffering from some disease. However, it is not appropriate to conclude that any one being merely free from illness or disease is healthy.

You might have seen people suffering from various types of diseases. Some of the diseases, like high blood pressure affect only a particular person who is suffering from it. On the other hand, some diseases like common cold, spread rapidly and affect a number of people in a very short period. You must have often wondered as to how does this happen. In one of the chapters of your textbook on Science, you would have studied about 'Why We Fall Ill'. In that chapter, it is mentioned how diseases are caused and how some of these affect only the persons who suffer from them are called non-communicable, whereas, there are those diseases that are transmitted from one



person to another are known as communicable. The chapter also mentions how communicable and non-communicable diseases can be prevented and controlled.

### 1.3 COMMUNICABLE DISEASES

Let us understand how communicable diseases are spread. These diseases are caused by certain infectious agents which may be bacteria or viruses. These are capable of being transmitted from person to person or from the environment to person.

#### 1.3.1 Classification

Communicable diseases can be classified on the basis of the causative organisms. These are as follow:

- Bacterial: Typhoid, Cholera, Tuberculosis
- Viral: Common cold, Influenza, HIV infection, Dengue
- Protozoal: Malaria, Kala azar
- Fungal: Fungal infections of nails, groins, skin, hair
- Parasitic: Infestations of intestinal worms, like round worm, or lice.

**Modes of transmission:** The modes of transmission can be classified as direct and indirect transmission.

##### (a) Direct transmission

As we have studied in our earlier classes, direct transmission of diseases takes place as follows:

**Direct contact or touching:** When we touch a person or come in direct contact with the skin or mucous membrane of the diseased person, it transmits infections like skin and eye infection.

**Droplet infection:** Spray of droplets of saliva or secretion of a diseased person spreads common cold, tuberculosis, meningitis.

**Contact with soil:** Can cause acquiring the disease agent directly and may spread diseases like: hookworm infestation and tetanus.

**Inoculation into skin or mucosa:** Certain diseases spread in other ways. For example, Rabies is spread to humans from animal. It is generally known that it occurs due to a dog or a monkey bite. Hepatitis occurs owing to virus, transmitted through contaminated needles. The HIV (Human Immunodeficiency Virus) can be transmitted by sexual contact or through transmission of infected blood from an infected person. HIV can be transmitted by the HIV infected mother to baby and can cause AIDS (Acquired Immune Deficiency Syndrome).

#### ACTIVITY 1.1

Discuss with your classmates, why we should not go to public places when suffering from cold, cough or fever?

*(b) Indirect transmission*

Communicable diseases are also transmitted indirectly in the following ways that are popularly known as '5Fs'— flies, fingers, fomites (material capable of carrying infections, like towels, handkerchiefs etc.), food and fluid.

Some diseases are spread through water, food, ice, blood and body tissues and organs. For example, typhoid, diarrhoea, polio, intestinal parasites and infective hepatitis. Flies contaminate food and other eatables.

A living carrier (also known as a vector) is a disease agent that lives on or inside the body of the carrier causing diseases like malaria and plague. Airborne infectious materials transmitted through droplet infection or dust cause diseases like respiratory infections and itch mites. Fomites are objects like towels, handkerchiefs, toys, glass, spoons, etc. which we use daily. Eye and skin infections and dysentery (diarrhoea with blood) are spread through these fomites. Our unclean hands and fingers act as disease causing agents and transfer infection to food through skin, nose, and causes diseases, such as intestinal parasites, dysentery, typhoid.

Healthy people can also spread disease if they are "carriers". These are the people who themselves may be immune to the organisms they harbour, but can be a source of transmission to others as happens in the case of typhoid.

**1.3.2 Prevention and Control of Communicable Diseases**

The following measures help in prevention and control the spread of communicable diseases:

*Personal hygiene*

- Bathing everyday and clean clothes keep our body free from harmful microbes.
- Cutting nails and washing hair regularly.
- Brushing teeth twice a day (morning and night) particularly after meals.
- Ensuring that your ears are clean.
- Do not share articles that are of personal use, that is, towels, soaps, tooth brushes, combs, razors and other toiletries.
- Wash hands before touching food or water and before eating or drinking.
- Wash hands with soap and water before touching your face, eyes and mouth and also before and after using the toilet.
- Many microbes like virus, bacteria and fungi are transmitted by touching surfaces with hands and

**ACTIVITY 1.2**

- List how many things you follow for food and water hygiene
- Discuss the list with your friend.
- What would you like to do to improve your personal hygiene.

**ACTIVITY 1.3**

Have a round of your school. Find out the environmental sanitation.

Discuss with your classmates. If it is not good what will you do? Prepare a plan and implement.

**ACTIVITY 1.4**

Prepare an Immunisation chart. Put it in your classroom. Discuss with your classmates whether everyone has been vaccinated? If not, request them to consult a nearby health centre.

become potential carriers. Hence by washing hands, we can prevent diseases like diarrhoea, flu, skin and eye infections.

*Food and water hygiene*

- Drink potable water. If it does not appear clean, boil or filter and then consume it.
- Eat only freshly prepared food or consume it within four hours of preparation.
- Do not purchase and consume fruits and vegetables which have been cut and kept in the open for a long time.
- Keep all food articles covered to prevent contamination by flies.

*Environmental sanitation*

- Use sanitary latrines; avoid open air defecation.
- Throw waste in dustbins to avoid breeding of flies.
- Clean the drains regularly.
- Regularly check the places where water is collected and has the possibilities of mosquito breeding. Spray insecticide to prevent breeding of mosquitoes.
- Try to prevent contamination of drinking water (source of water should be away from source of garbage collection/waste disposal site). The container of drinking water must be kept at a clean and safe place.

*Vaccines*

Vaccines boost immunity and thus helps the body fight diseases. A large number of infectious diseases can be prevented by taking vaccines at an appropriate time, such as, diphtheria, pertussis, polio, tetanus, rabies, measles, chickenpox, typhoid, etc.

*Treatment of diseases using medicines*

Medicines kill microbes and /or slow their growth. These are classified as anti-virals, anti-fungals, anti-protozoals and antibiotics according to the group of microbes they act upon. However, these medicines should be taken in the recommended dose and duration as advised by the doctor. One should avoid self-medication.

*Isolation of patients with communicable diseases*

Patients suffering from such diseases that are communicable should be kept in a clean environment isolated from others.

*Education and awareness*

It is important to make people aware about communicable diseases, their causes and modes of spread. People should

also be made aware of their responsibilities towards control of communicable diseases, e.g. ensuring use of safe water, healthy food and proper management of garbage and waste disposal.

**1.4 NON-COMMUNICABLE DISEASES**

The non-communicable diseases may occur due to genetic and lifestyle factors. When these are caused by an unhealthy lifestyle, these diseases are also called lifestyle diseases. Risk factors of non-communicable diseases include lack of physical exercises, poor dietary habits, inadequate sleep, stress and habits like smoking, taking alcohol and tobacco chewing.

An arbitrary classification of non-communicable diseases can be:

*Lifestyle diseases*, such as diabetes, hypertension, heart diseases, stroke and cancer.

*Mental health* diseases like depression; and trauma.

Given below are the behavioural risk factors which can give way to manifestation of the physiological risk factors and ultimately lead to the diseases.

**1.4.1 High Blood Pressure or Hypertension**

**Box 1.1**

- If one is obese one has a high chance of getting diabetes and hypertension.
- Hypertension increases risk of getting heart attacks and strokes.
- Diabetes mellitus affects all parts of the body like brain, eyes, heart, kidneys, blood vessels, muscles and nerves if precaution is not taken.

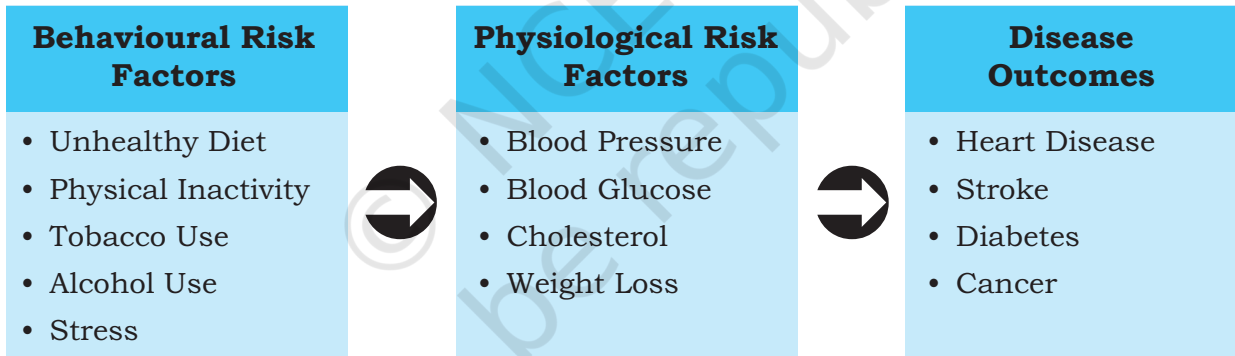

**Source:** National Programme for Prevention and Control of Cancer, Diabetes Cardiovascular Diseases and Stroke, A Guide for Health Workers, Ministry of Health and Family Welfare, GOI, New Delhi. For details on BMI, refer to chapter IV Activity 4.2

Fig. 1.1 : Risk Factors

*Dietary factors*

All packaged and canned food items contain a very high level of sodium because of the presence of salt that is used as a preservative. If you are in the habit of adding table salt to your food you are consuming excess salt. Use of excess salt is linked with hypertension. Hence, consumption of excessive salt in daily food, packaged and canned foods need to be avoided.

*Sedentary lifestyle and lack of exercise*

You can put on excess weight, if you do not exercise daily. This excess weight and lack of exercise can lead to hypertension.

**ACTIVITY 1.5**

- Interact with your group and note the causes that lead to hypertension on a chart.
- Make a list of processed foods that contain of high level of sodium by reading the label.

In addition to taking the prescribed medication, doing regular exercises and taking high fibre diet can help one to control hypertension.

*Mental stress and chronic anxiety*

People who cannot manage stress and constantly worry about things, are prone to hypertension. Hence, one needs to learn to cope with stress in a healthy way by doing meditation and yoga and diverting attention by observing healthy mental habits like listening to music, reading, writing poems, pursuing a hobby, etc.

*Tobacco use*

Intake of nicotine either through smoking or chewing tobacco may lead to hypertension and should be avoided. Consistent use of tobacco, *gutkha*, *khaini*, etc. has been linked to various types of cancer. The consumption of tobacco, therefore, must be avoided.

*Endocrine Diseases*

Diabetes mellitus is one of the endocrine diseases. It is caused due to inadequate secretion of the hormone insulin from pancreas. Insulin regulates the level of sugar in our body. Lack of insulin causes increase of sugar in our body leading to the condition called diabetes mellitus. Common symptoms of this are increase in hunger, frequency of urination, and growing thirst.

Until recently, most children and adolescents with diabetes were thought to have Type 1 (insulin dependent) diabetes. However, Type 2 diabetes mellitus (DM Type 2) among children is now being increasingly reported from several parts of the world. Adolescents who are obese are more likely to get Type 2 diabetes which is manifested as high blood sugar. If untreated, it leads to complications in kidneys, eyes and other organs systems in the body. Diabetes can be managed primarily by bringing about changes in lifestyle and physical exercises and medication.

*Hereditary Disorders*

Genetic disorders such as hemophilia, thalassemia, muscular dystrophy are hereditary diseases which run through generations in a family. Constant care and support may help the concerned individual manage these disorders.

**1.4.2 Prevention and Cure**

In India, non-communicable diseases cause major health problems. These diseases cause disability, loss of income, disruptions in family environment and poor quality of life in the most productive years. We are going to have the highest incidence of diabetes in the world by 2020. You may have heard



about young people having heart attacks and requiring bypass surgery. We need medical help for treatment. However, efforts should be made to prevent them. We can prevent these, if we adopt a healthy lifestyle right from childhood and continue it throughout life. Non-communicable diseases can be prevented in the following ways:

*Healthy diet*

Eating a balanced diet helps in the prevention of obesity and other lifestyle diseases. The balanced diet includes fruits and vegetables, preferably locally available and seasonal, wholegrain products (including pulses), milk and milk products.



Fig. 1.2 : Healthy Diet

*Adequate sleep*

We all require daily 6–8 hours of sound sleep. Inadequate sleep leads to changes in blood pressure, increase in stress level and disturbance of what is called the biological clock.

*Regular exercise*

People who undertake physical exercise and yoga activities daily keep themselves physically fit, feel happy and do not put on excess weight.

One must do 20–30 minutes of physical activity daily to keep fit. This can be done by taking part in sports. Exercising or spot jogging can be done at home. Simple walking, climbing stairs, not using the lift and skipping have the same effect. Gym is another dedicated place for workouts.



Fig. 1.3 : Regular exercises

**ACTIVITY 1.6**

- Recall the physical activities done by you in the last week and prepare a brief note on the following.
  - Do you play any game regularly?
  - If yes, for how long?
  - How often does your school organise physical activities/Yoga during the week?

**Box 1.2****Do You Know?**

- There should be no tobacco shop within 100 yards of an educational Institution.
- Sale and purchase of tobacco related items like *cigarette*, *gutkha* by minors and to any one (below the age of 18) is prohibited.

**ACTIVITY 1.7**

Is there a shop which sells tobacco products near your school? Have you observed any student purchasing *pan masala*, *gutkha*, *khaini* or *cigarettes*? Discuss with your teacher what steps can be taken to address this issue.

*Mental relaxation*

If a person is not able to handle stress, he/she experiences anxiety and depression. This weakens the immune system and one falls sick very often. One can also experience psychosomatic symptoms like headache, bodyache, stomachache, fatigue, inability to concentrate and loss of interest in all activities. Meditation, relaxation, exercises and other yoga activities help reduce stress. You can also engage in hobbies like drawing, painting, listening to music and so on as relaxation techniques when under any type of stress. All these have positive impact that reduce anxiety and depression and prevent diabetes, hypertension and heart attacks in the long run.

*Avoiding the use of tobacco, alcohol and drugs*

Use of tobacco, both by way of smoking and consuming chewable tobacco in any form directly contributes to heart disease, stroke, chronic lung disease and common cancers. Even the non-smokers inhale the smoke released by smokers around them. Therefore, prohibition of smoking in public places is an example of a public health regulation that decreases the risk for non-smokers. You should *request the smokers not to smoke in public places*. You may avoid company of smokers.

Alcohol use contributes to chronic liver disease, depression and injuries, especially motor vehicular injuries. Both alcohol and drugs can have long term effects not only on the physical health but also on the mental health.

Excess stimulants like caffeine in tea, coffee and cola drinks also have a harmful effect on our body as they cause rapid increase in heart-beat rate, lack of sleep and elevated blood pressure. These may also cause acidity and stomach ulcers.

Addictive drugs impair social and occupational functioning and are associated with impaired mental health.

*Antioxidants*

Antioxidants help in prevention of the damage, repair of cellular functions and delay in the ageing process. Fresh vegetables, fruits and dry fruits are rich sources of antioxidants.

Use of Ayurvedic, Homeopathy and Unani medicine also help in the cures of Non-communicable Diseases.

Ayurveda is the science of life and health, developed in India since ages. It lays emphasis on prevention and promotion of health in addition to curing the diseases. The treatment under Ayurveda can be successfully used in early stages of diabetes, liver-disorders, skin diseases, stress, insomnia (sleeplessness) and anorectal-diseases. Some specialised Ayurvedic treatments can be helpful in diseases like joint-pains, neuromuscular diseases and paralysis.

Both Homeopathy and Unani systems of medicine are also used in the treatment of non-communicable diseases.

Homeopathy is that system of medicine which is based on the nature's law of cure. It is a safe and effective method of treatment. It helps in increasing the immunity of the body and offers in many cases a long lasting cure.

Unani system of medicine is also the natural way of treatment with the help of herbal medicines. According to this system, the health of a person depends on the balance of four elements in the body. These are *Dam* (blood), *Balgham* (phlegm), *Safra* (yellow bile), and *Sanda* (black bile). The Unani medicines are given to the person suffering from a disease to promote an equilibrium of these elements in the body.

## 1.5 REPRODUCTIVE HEALTH

You have read in your previous classes that cell is the structural and functional unit of our body. To perform various specialised functions, nature has divided our body into many functional units or systems comprising different organs. One such system is the 'reproductive system'. It is made up of reproductive and genital organs. You will study more about the structure and functions of the reproductive system in your science classes. In this chapter you will learn about the need to keep it healthy. In fact, reproductive health refers to healthy reproductive organs performing normal functions. But there are diseases that adversely affect this system. These are as follows:

### 1.5.1 Reproductive Tract Infections (RTIs) and Sexually Transmitted Infections (STIs)

Reproductive Tract Infections (RTIs) and Sexually Transmitted Infections (STIs) are non-communicable diseases which affect the quality of life and have important bearing on the reproductive functions. RTIs are infections involving reproductive organs. These can be caused by various microbes like bacteria, viruses or protozoa. Improper maintenance of hygiene of the genital organs or through infected instruments used in medical procedures for treating genital organs also result in reproductive tract infections.

STIs are infections which are transmitted through close physical and sexual contact between individuals. However, STIs like infections through Human Immunodeficiency Virus (HIV) and hepatitis B and C can also spread by non-sexual modes like sharing of needles, transfusion of infected blood and using infected equipment for surgery.

### Box 1.3

#### Do You Know?

- One should not administer self medication.
- We must always consult the doctor before taking any medication.

### *Signs and symptoms of RTIs and STIs*

- Itching or burning sensation in the genital organs
- Foul smelling discharge from vagina or penis
- Blisters, sores or swelling on or near genitals, anus or its mouth
- Pain, burning sensation and increased frequency of urine.

There may be one or more of the above symptoms.

### *Prevention and control of RTIs and STIs*

RTIs and STIs not only lead to poor quality of life. These can also lead to complications.

Proper genital hygiene should be maintained to prevent RTIs. In girls and women, during menstruation there are more chances of getting infection because of the flow of blood. Hence, adequate precautions with regard to hygiene need to be followed: one should have daily bath and clean the genital area with soap and water and stay away from casual sexual relationships and have responsible sexual behaviour. If sexual relation can not be avoided, a condom must be used.

In case of problem, treatment from a qualified doctor should be taken and one should avoid going to quacks for treatment. One should not feel shy to discuss the problem with the doctor. Complete and proper treatment of both the partners is necessary in the case of RTIs and STIs.

### *Menstrual Hygiene*

The following steps must be taken by women and girls for maintaining menstrual hygiene:

- use clean home made or disposable pads/napkins during menstruation;
- change the sanitary pads at frequent intervals, at least twice a day;
- if home made cloth napkins are reused, they should be washed daily with soap and water and dried in a sunny and dry place to prevent infection.

## **1.6 HIV AND AIDS**

HIV stands for 'Human Immunodeficiency Virus'. It is a virus which is found only in human beings and affects the immune system in humans. When the HIV remains in the body for a long time, it destroys the immune system.

Many diseases like tuberculosis, fungal infections and cancer begin affecting the body and the person is said to be having AIDS (Acquired Immune Deficiency Syndrome). However any person suffering from T.B., cancer or fungal infection should not be considered suffering from HIV and AIDS.



Acquired means it is not genetically inherited. Immune deficiency means that the defence mechanism of the body, the immune system becomes weak, and Syndrome means that when the individual has AIDS, it is not just the signs and symptoms of one disease, but a group of diseases, that appear in him/her.

When a person is said to be HIV positive, it simply means that HIV is present in his/her body. The interval between acquiring HIV infection and AIDS may be up to 10–15 years. It depends upon many factors like the status of the immune system at the time of entry of HIV in the body, regular treatment of illnesses, good diet and healthy lifestyle that the individual has.

### 1.6.1 HIV Transmission

HIV is transmitted through:

- having unsafe sexual contact with an HIV infected person. This is the most common route of transmission;
- HIV infected mother to her new born child;
- Transfusion of HIV infected blood; and
- Sharing of needles and syringes with a person infected with HIV. This is most common in people who are habituated to intravenous drug use.

HIV does not spread through air, water or food. Transmission of HIV also does not occur through mosquito or animal bites because the virus does not survive or reproduce outside the human body. When the mosquito bites, it sucks blood from human body and does not inject into it. Therefore, even if a mosquito bites a person immediately after biting an HIV infected person, it does not inject the infected blood into his/her body.

Because of these myths and misconceptions, a lot of HIV infected persons, especially women, are abandoned and rejected by their respective families and are discriminated by the society.

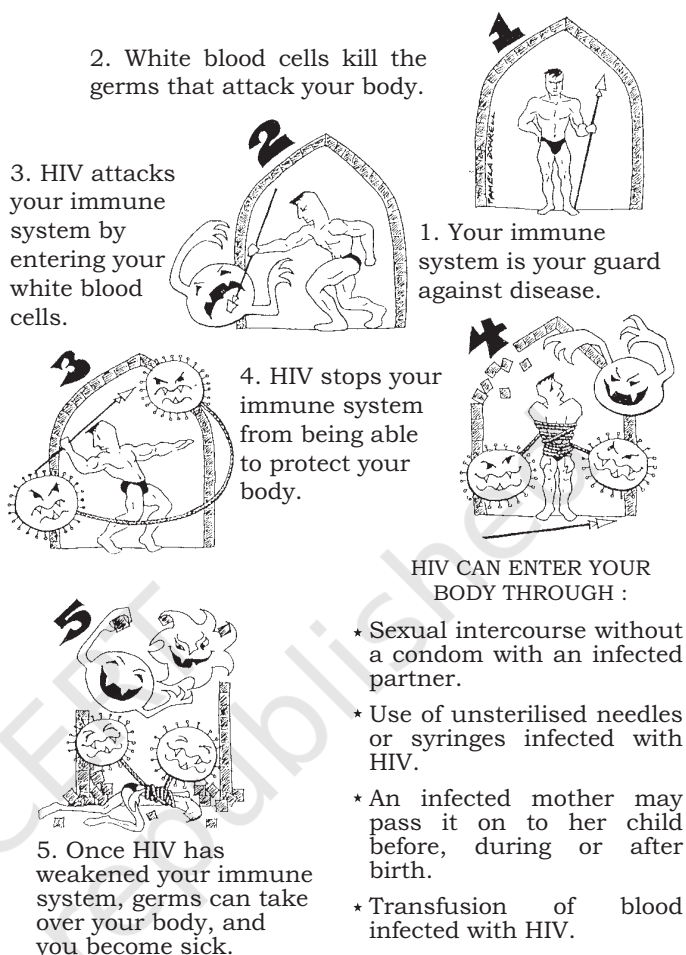

Fig. 1.4 : How HIV weakens the Immune System

### Box 1.4

The first case of AIDS was reported in 1981. Since then it has killed more than 25 million people. India is having the second largest number of HIV infected persons and around half of all the new cases are occurring in young people. Prevention is the best strategy to protect oneself from HIV and AIDS.



**ACTIVITY 1.8**

Prepare a list of myths and misconceptions regarding HIV and AIDS and discuss with other students.

These myths and misconceptions have no scientific basis and need to be removed by discussing these with the people and spreading awareness about HIV and AIDS. This will prevent discrimination against HIV positive people and help them live longer.

**1.6.2 Detection of HIV and AIDS**

HIV infection can only be diagnosed by a specific blood test done at the Integrated Counselling and Testing Centres in

**ACTIVITY 1.9**

**Read the following two case studies and discuss with your classmates the questions given at the end of each case study.**

**Situation 1**

Mahesh and Ratan, both 15 years old, have been friends with a group of boys in their neighbourhood for the last five years. Their friends pressurise them into taking drugs including drugs through injection. Both refuse but when their friends begin to make fun of them, Mahesh, out of peer pressure and fear, experiments with injectable drugs. He does not want to be the odd one in his group. He uses the same needle that the other boys use. Soon, he is addicted to injectable drugs. Ratan, on the other hand, decides to leave the company of the friends. He even advises and pesters them to go to the doctor for help in giving up drug abuse.

1. What was the role of Mahesh's so-called friends in influencing his decision?
2. Could Mahesh have behaved differently? If yes, explain what could he have done?

Do you know any drug de-addiction centre near your locality?

Take the help of your teacher and make a list of de-addiction centres. Put these on the Notice Board of your school. Enact this case study. Think what would have you done, if you were Ratan?

**Situation 2**

A daughter of a very senior company personnel was expelled from the school because her parents were detected HIV positive. The school Principal felt that the parents did not observe moral behaviour which led them to be HIV positive. The administration believed that the incident would have a negative impact on the school environment and therefore, their child should not be allowed to study in the school. However, as per the medical reports of the mother, blood transfusion during an operation was the cause of acquisition of HIV by the mother.

1. Is the action taken by the Principal of the school justified?
  - Have a discussion in the class with your classmates regarding possible ways of acquiring HIV and AIDS.
  - In this case, what would you like to do, so that the girl should continue to study in the school.
2. Even if the HIV infection would have taken place otherwise and even the daughter would have been HIV positive, was the action justified?

government run hospitals. These centres maintain complete privacy and confidentiality. The test detects antibodies produced in the body against HIV. As the HIV antibodies appear only after six weeks to six months after acquisition of infection, the test will be negative if it is done during this period. This period of time is referred to as the “window period”. Thus, one should wait for the window period to be over to get the test done.

Although there is no definite one set of symptoms of AIDS, when an HIV positive person develops AIDS, he/she has one or more of the following symptoms like weight loss greater than 10 per cent of body weight, fever and/or diarrhoea for a period longer than one month and persistent severe fatigue. However, one should also understand that these signs and symptoms can be of any other disease. Once a person is diagnosed with HIV infection, he/she needs to be treated urgently in a well equipped hospital.

### 1.6.3 Risk Factors for Acquiring HIV

The activities which are of high risk for acquiring HIV infection are:

- (a) having unprotected sex (i.e. without using condom) even if one know the person well.
- (b) having many sexual partners.
- (c) sharing syringes or needles while injecting drugs.
- (d) blood transfusion with blood that is not certified as HIV free.
- (e) ear piercing, acupuncture, etc. The instruments used for these procedures must be sterilised before use.

### 1.6.4 Responsible Sexual Behaviour to Prevent HIV and AIDS

While sexual route is the most common in transmitting HIV as stated earlier, it is very alarming to note that more than 50 per cent new cases are occurring in India among the adolescents and youth. During the process of growing up, important physical, physiological, psychological and social developments take place among adolescents. They are attracted towards opposite sex or same sex, do experiments and are curious about many such feelings. They act under peer pressure very often, which sometimes is the driving force behind unsafe experiments like drug abuse or unsafe sex.

We must always remember that along with rights we also have certain responsibilities. Irresponsible sexual behaviour causes harm to self and others. A knowledge-based choice and decision towards sexual behaviour can prevent many future complications including emotional turmoil, unwanted

pregnancy and diseases like STIs, HIV and AIDS. Thus, adopting a responsible sexual behaviour go a long way in protecting oneself from the menace of HIV and facilitate to live a healthy, happy and a productive life. It is equally important to avoid drug abuse specially through needle-sharing.

## ASSESSMENT

### Answer the following questions

1. How can we prevent indirect transmission of communicable diseases?
2. What steps are required at the individual and society level to prevent communicable diseases?
3. List major risk factors for non-communicable diseases.
  - (a) .....
  - (b) .....
  - (c) .....
  - (d) .....
  - (e) .....
4. Why are young people suffering from heart diseases now-a-days? Give reasons. Can you suggest some ways to prevent these?
5. The obesity among children and adolescents is becoming a major cause of concern for the parents and health personnel. What can be done to prevent overweight and obesity?
6. Why are adolescents more vulnerable to HIV infection? Give reasons.
7. List some ways in which you can manage your anxiety and stress.
8. Why do you need to make exercises an integral part of your life style? How can you do it?

9. Prepare a table as shown below showing communicable diseases, ways of its transmission and its prevention and control.

Sr. No.	Name of the Communicable Disease	Ways of transmission	Prevention and Control

10. Prepare two slogans each for generating awareness about prevention of HIV among your peer group and community.

© NCERT  
not to be republished

# Growing up with Confidence



13149CH02

## Box 2.1

Adolescence is the period of transition between childhood and adulthood in human lifespan. It is generally been between 10-19 years of age. It is a period of rapid physical, cognitive, socio-emotional and behavioural changes. WHO states that- “there are certain attributes that mark adolescence which include appearance of secondary sex characteristics (puberty), attainment of reproductive maturity, development of adult mental processes and adult identity and transition from total socio-economic dependence to relate independence”.

## 2.1 INTRODUCTION

You have already learnt about growing up as adolescents in Class VIII through your science textbook. Growth is a natural phenomenon. Growth is a characteristic feature of all living beings. You must have seen seeds growing into seedlings, which then grow and develop into plants, or pups growing into dogs, kitten into cats and so on. Similarly an infant passes through different phases of growth from childhood to adolescence to adulthood. Although all the stages of growth and development are significant, it has been universally recognised that the stage of adolescence is the most critical one.

This chapter deals with the pattern of human growth with special emphasis on the growth spurt that takes place during adolescence which means by rapid changes in the body, psyche and behaviour. An adolescent, well aware of pubertal changes, must be able to understand and accept the changes with confidence, and not fall into the trap of escapist strategies such as drug abuse. *Growing up with confidence* needs proper understanding of various issues and concerns related to adolescence such as growth and development, self-concept and self-esteem, anxiety and depression, nutritional needs and sexual desires or any kind of harassment. Understanding these issues and concerns will help develop a positive attitude towards gender concerns and building healthy relationships.

## 2.2 GROWTH: A NATURAL PHENOMENON

Recognition of adolescence as a distinct stage in the development of human beings began during the early part of the 20th century. Growth during adolescence is mostly portrayed as an exclusive characteristic of this period, making one believe that growth during other stages — childhood, adulthood and old age is hardly significant. But you would have observed that we have all been growing up since we were born without consciously realising it. We can appreciate the phenomenon of growth during all stages of human life by undertaking the following activities.

### 2.2.1 What is Growth?

Let us understand what is growth? Growth may be defined as the quantitative increase in size or mass. When weight is measured in kilograms and height in centimetres from time to

### ACTIVITY 2.1

1. You may collect pictures from old magazines or newspapers and paste them on a sheet of paper to exhibit the life history of a plant or an animal or stages of human lifecycle beginning from infancy to old age. You may even draw them.
2. In your diary, list the changes that you have undergone from the time you were nine years old, till now. Mention physical, emotional as well as psychological changes which you experienced. Prepare a write-up on those changes particularly focusing on whether the changes that made you feel surprised or stressed till you realised that these changes are normal and natural. You may discuss these changes with your friends. You will realise that these changes during adolescence do not begin at the same age in all the growing children.

time, we can know how much growth has occurred in a child. When the organs of the body grow, the number, the size and the weight of their cells increase. Growth can be measured in terms of the change in length, width, depth and volume in a specific time period. Although growth is a characteristic of living beings, in all living beings, the rate of growth also depends on nutrition and living conditions, including the environment at home.

#### 2.2.2 Growth, Development and Maturation

Growth, development and maturation occur side by side. Growth is a quantitative increase in size through increase in number of cells or elongation of cells. Development may be defined as the progression of changes, both qualitative and quantitative, which lead to an undifferentiated mass of cells to a highly organised state. Maturation is a measure of functional capacity. For example, a child begins to speak by making unintelligible sounds. Then, slowly it acquires the capacity for speaking in a manner, which is easily understood by others. Another example of maturation is when a child begins to crawl and then matures to a state of walking on two legs. Similarly, organs of reproduction reach maturity at the end of puberty.

### 2.3 DETERMINANTS OF GROWTH AND DEVELOPMENT

Although age related events of growth, development and maturation in human beings are mostly the same in all cultures, however, some variations do exist. This is because growth is affected by both genetic and the environmental factors. Growth is also influenced by the socio-cultural context. For example, in the economically backward families, the growth of family members gets stunted due to undernourishment. But even in economically sound households, the members may not be taking a nutritious diet. Many children who eat junk food all the time become obese. In fact, growth and development of a human being is a result of a combination of heredity and environment.



### 2.3.1 Role of Heredity

Parents contribute genes to their biological offspring, so the children tend to resemble their parents in stature, body proportions, body composition, and pace of growth and development. Individual genes, however, are not solely responsible for growth, nor do they directly cause growth. Several genes jointly control growth. The hormonal and nervous systems also have an important role to play. Hormones from endocrine glands provide the requisite environment for gene action throughout life. For example, growth spurt during adolescence requires the secretion of adequate amounts of growth hormones into blood so that the genes regulating growth of skeleton, muscles and fat become active to the required extent. Because of inheritance, children of tall parents are likely to be tall and children of short parents tend to be short. One needs to understand the role of heredity in the context of development of body physique. Therefore, one should not develop a negative or positive image of oneself on the basis of one's physique. Also, some individuals have a constitution which makes them look tall (ectomorphic), some medium sized (mesomorphic) and some have a small but rounded built (endomorph). Thus, a normally growing adolescent should not base self-image on these factors as they are beyond one's control.

### 2.3.2 Role of Environment

Growth and development are also influenced by environmental factors. The role of nutrition, child rearing practices and the psycho-social environment provided by the family is very critical.

**Nutrition:** A nutritious diet favours growth. Growth requires multiplication of cells or enlargement of cells, which depends on an adequate supply of nutrients. In fact, at every stage, the body needs a basic level of nutrients for its sustenance. Nutrition is, therefore, the most important external factor for growth. You have learnt in earlier classes in your science lessons that essential nutrients in a human diet are:

1. Proteins and amino acids
2. Carbohydrates and sugar
3. Lipids – fats and oils
4. Minerals – Macronutrients: Calcium, Phosphorus, Sodium, Potassium, Sulphur, Chlorine, Magnesium.  
Micronutrients: Iron, Zinc, Manganese, Iodine, Cobalt, Copper, Molybdenum, Nickel.
5. Vitamins – Vitamins are of two kinds  
Fat soluble: Vitamins A, D, E, K  
Water soluble: Thiamin, Riboflavin, Niacin, Folic Acid.
6. Water

#### Box 2.2

Deficiency of iodine in food causes retardation of mental and physical growth. Can you now explain the importance of consuming iodised salt?

Nutrients are obtained from food. Both quality and quantity of food are important. Food provides energy, and energy (in kilo calories) is required not only for growth but also for maintenance of the body, its working as well as reproduction.

A balanced diet contains all the nutrients in appropriate quantities. Undernutrition during childhood results in slow growth and delayed maturation. If continued into adolescence, it leads to short stature adulthood. Nutritional needs during adolescence are more than that during childhood. Dietary deficiencies retard the growth. The nutrient requirement however varies among adolescents since rate of physical growth is not the same in all. In populations with food shortage, growth of children is delayed. They may be shorter or of less weight due to malnutrition or undernutrition.

### ACTIVITY 2.2

**Read the following case studies carefully and reflect on the question asked at the end of each case study.**

**Case 1:** Fourteen years old Suleman and George were very good friends who also shared their birth date. Suleman's parents were quite tall. While Suleman was 5 feet 6 inches tall, George was only 4 feet 9 inches. George wanted to be of the same height as Suleman and would hold on to a rod and hang from it but to no avail. Then they approached the counsellor in school.

Guess what counselling was given by the counsellor?

**Case 2:** Suresh was a small-built boy studying in Class IX. Not only was he short and skinny but also had a tired look on his face. After a medical examination by the school doctor, parents took good care of Suresh. By the time Suresh got into Class XI, he was as grown up as his classmates. The doctor gave no medicines to Suresh.

How do you think Suresh attained normal growth?

### 2.3.3 The Psycho-social environment

The quality of emotional and psychological environment in which a child lives and grows do influence the hormonal balance of the body, thereby affecting growth. Growth gets retarded as a result of emotionally stressful environment.

Physical and psychological stress together have been found to influence growth and development in girls with respect to menarche and menstruation. The age of attaining puberty among boys and girls varies. Some adolescents show signs of early maturation, while others mature late. Highly competitive track athletes who enter training before puberty have been found to show delayed menarche. It is possible to explain the delay due to the elevated levels of certain hormones in blood during severe physical exercise. These hormones delay

**Read the following case study carefully and reflect-**

**Case 3:**

Neeta and Sheena have been friends since they were five years old. They sit together in class. They come to school together as they are also neighbours. When they were 12, Neeta began to menstruate. Sheena showed breast development but no signs of menarche even when she was 14. Both friends spoke to the teacher about their worry regarding Sheena.

What do you think the teacher said which rid them of their anxiety?

the onset of menstruation. The timing of menarche is possibly the best researched adolescent event known to be affected by factors like heredity, nutrition, illness, socio-economic status and psychological condition.

**2.3.4 Socio-economic Status**

Socio-economic status also affects growth. Poverty and low socio-economic status lowers the rate of growth in youngsters. Such retarded growth in socially weaker sections of the society is linked to heavy physical

labour and the stress associated with it. Malnutrition and an unhygienic environment is also not congenial for growth.

**ACTIVITY 2.3**

**Read the conversation between Srinivas and his friend Ali**

Srinivas of Class IX (age 13) who is short and skinny is teased by his classmates, who call him 'dwarfy'/'bauna'/'gittha'. Srinivas stops going to school. One day his class friend Ali meets him in the market and enquires about his absence from school.

**Ali:** A lot has been done in the class and exams are approaching. Why are you not coming to school? Even the teacher was commenting on your absence.

I am your friend. Tell me what is wrong. I shall try and help you.

**Srinivas:** He breaks down. We are six siblings living with our parents in a small shanty (*jhuggi*). My father is alcoholic. My mother works harder than her body can allow, for earning some money for the family. There is never enough to eat. We are always fighting. On top of that the bullies of the class tease me. In any case, I need to supplement family income by taking up a job.

Analyse the situation, which led to slower growth and natural development in Srinivas.

What are the factors affecting the growth of Srinivas?

If you are Ali, what will you do.

**2.4 SELF-CONCEPT AND SELF-ESTEEM**

Growth and development during adolescence do affect self-concept and self-esteem. The concept of 'self' becomes evident in boys and girls as they enter their 'teen' age. Several changes begin to occur in their body and psyche. As a result, the attention is focused towards 'self'. As the concept of 'self' develops, it makes the teenager develop less dependence on parents. Self-image becomes important not only for oneself

but also in the eyes of others. There is a tendency for looking into the mirror and admiring oneself. Grooming oneself to look beautiful or handsome to others is always at the back of the mind of young boys and girls.

Support and guidance from parents and teachers and friendship with peers help in developing 'positive self-esteem'. Self-esteem is also a kind of self-recognition. It is important for growing up with confidence.

The consequences of low self-esteem and self-image are detrimental to efficiency. Try to have high self-esteem and a positive self-image.

Peer group is important because friends and peers may help to sort out confusions regarding rapidly occurring changes in the body. Similar changes in friends of the same age reassure that all is normal. As adolescents grow, they emotionally move further from parents to become independent adults. Acceptance among peers becomes important. Company of wrong peers or adults becomes risky during early adolescence.

## 2.5 PSYCHOLOGICAL SECURITY

For developing self-confidence and self-esteem, it is essential to have a stress-free environment. Adolescence is a period of losses—loss of childhood, loss of sexual innocence, loss of freedom from responsibility. Adolescents need parental support to cope with these losses.

Psychological security depends a lot on how a boy or girl was valued by the family as a child. You may have seen that teenagers who have experienced encouragement from others with respect to values and parental expectations tend to be psychologically more secure than those who are subjected as children to shame and punishment.

A psychologically secure teenager is able to concentrate on studies, have respect for parents, spend time judiciously on hobbies and establish healthy relationships. Adolescence has to be viewed as a period of gains too—the adolescent attains a beautiful physique, figure and face. Another gain is the maturity of brain, which leads to rational thinking and better understanding of subjects and issues. But to ignore the losses and carry the gains forward, support from parents/guardians, teachers, and peers goes a long way in helping the youngsters cope with changes occurring during adolescence.

### Box 2.3

Did you know?

- Awareness of positive qualities makes one feel good and enhance self-esteem.
- When we feel good, we respond to every situation more positively.
- Appreciating others makes us feel good.

### ACTIVITY 2.4

Write ten sentences on 'Me — in my own eyes', in your diary. Analyse your writing. Do you feel that you have desirable self-esteem and self-confidence? Express your feeling in three sentences.



**Source:** Poster designed by Laxmi Narayan Mochi from Class XII JNV, Mandaphia, Chittorgarh, Rajasthan

Fig. 2.1 : Peer Group



## Box 2.4

**Read carefully the following situations and try to respond to the given questions.**

**Situation 1:** Shalini and her friends in Class IX were preparing for the school’s annual function. All of them were very excited. Anita, one of Shalini’s classmates, mocked at her, “You are so dark. We will need additional light to be able to see you on the stage.”

Shalini’s good friend, Madhu, felt bad for Shalini and advised her to use a cream to make her complexion lighter. “You already dance so well. Can you imagine how nice you will look on the stage if you had a lighter complexion?”

Shalini smiled and said, “Thank you, Madhu. I appreciate your concern but I am happy with my complexion. My teacher and I am working hard on my dance practice and I am confident that our efforts and your good wishes will lead to a good performance.”

1. What do you think of Anita’s remark about Shalini?
2. Do you think that having a light complexion is important for being beautiful?
3. Do you think that Madhu is trying to perpetuate the stereotype that having a light complexion is an important component of being beautiful?
4. What do you think of Shalini’s response?

**Situation:** Raja has an overbearing father who also becomes cruel if he is angry at Raja. Raja hates to go home. He roams around with his friends till dinner time. He feels he is good for nothing.

1. How can Raja’s plight be improved?
2. Who can help and how. Substantiate your answer with reasons.

(a) Teacher      (b) Counsellor      (c) Classmates      (d) Parents      (e) All



Fig. 2.2 : Parent-child Communication

### 2.5.1 Psychological Insecurity and Mental Illness

Psychological insecurity expresses as anxiety and depression and in severe cases may result in psychosis, which is a mental disorder. Psychologically insecure individuals may even attempt suicide.

## 2.6 ANXIETY AND DEPRESSION

During growing up, adolescents also become victims of anxiety and depression.

### 2.6.1 Anxiety

Anxiety is not abnormal. Everyone gets the feeling of anxiety sometime or the other. Anxiety is an apprehension of something unpleasant or some danger. It causes mental discomfort and pain. It may sometimes prove to be useful, for example, before an examination or competition. But an abnormally high level of anxiety is counter productive as it distracts and lowers the span of attention. Adolescents sometimes panic out of anxiety without knowing the reason. They may even feel a fear of failure in future. This makes them tense and tired. Anxiety may

manifest as a need to get medical treatment for an imaginary sleep disorder or some other physical complaint. It may also manifest as over breathing (hyperventilation syndrome). Anxiety may even be due to separation from parents or even for having to attend school out of compulsion or due to sex drive. Adolescents may try to get out of anxiety by self-help. The right treatment for anxiety lies in seeking help from parents, teachers, counsellors and even friends.

### **2.6.2 Depression**

Feeling 'sad' or low is common among the adolescents. If the feeling is short-lived there is no problem. But sometimes symptoms of depression show up as social withdrawal, need to weep, eating and sleeping problems, and feeling of dejection and hopelessness. Depression at times leads to hostility towards parents, society and peers. 'Anger' is sometimes a psychological reaction for fighting depression. If an individual faces pressure, he/she should be empowered to access or seek information, advice, support through appropriate communication from significant adults such as the parents, teachers, elders, relatives, peers, counsellors and health professionals. The best way to get out of depression is to engage oneself in various types of physical activities and hobbies.

### **2.6.3 Psychosis**

Psychosis is a medical term for a serious illness in which the patient loses contact with reality. The perception in the patient's mind has no connection with reality of the outside world. The quality of relationships declines progressively and contact with others lessens with time in a psychotic person. A psychotic may also suffer delusions and hallucinations in which the patient imagines voices and happenings which are far from real. Psychosis may result from abuse of alcohol and drugs, injury and traumatic events.

### **2.6.4 Suicidal Tendency**

Depression and suicidal tendencies often go together. It is unfortunate that often a trivial problem drives a person to commit suicide. The person feels that it is difficult to run away from unhappiness and death can be the only solution. Suicide in adolescents is mostly due to a sense of guilt or failure. Suicidal behaviour is usually impulsive. It is attempted to punish the self or a loved one. Often suicide is followed by a quarrel with a loved one. It springs from loss of reasoning, which is usually temporary. For teenagers, or for that matter for everyone, it is important, therefore, to think about the consequences



before taking any extreme step. The need is to take care of such adolescents and help them overcome depression. It is the responsibility of the parents to take to the child or consult a counsellor if they see any symptoms of depression before it is too late.

## 2.7 DRUG OR SUBSTANCE ABUSE

Young people are more vulnerable to drug or substance misuse and abuse due to peer pressure, poor self-esteem, low achievement at school or family history of drug or substance abuse. Drugs are chemicals. Some are used for treatment and help in recovery from an ailment. But when drugs are used for purposes other than treatment, their consumption becomes 'drug abuse' rather than 'drug use'. Many a time drugs given for medical treatment are also abused as in the case study given below.

Certain drugs serve no useful purpose; instead have adverse effects on the body. Drugs such as Marijuana, hallucinogens and tranquilisers which have an effect on the brain and drive the user into a make believe world of fantasy and provide false feelings of being free from problems. These are not only addictive but also have an adverse effect on the brain.

### ACTIVITY 2.5

#### **Read the following case and give your opinion.**

Raman, Robin and Rina, students of Class XII, are good friends. Robin lives in a hostel nearby. He once got a bad cold and cough. The doctor prescribed a cough syrup. Robin was soon cured. When Robin was ill, Raman and Rina used to visit his room regularly to know about his health and extend their help to him. Once, during such a visit, while Robin was taking his medicine he mentioned its good taste. Later, whenever Rina and Raman came to Robin's room, Raman would taste the cough syrup. He soon acquired such a strong taste that he went and bought the cough syrup for himself from the chemist. Now he has started consuming the syrup everyday and does not feel comfortable if he misses it even on one day.

#### **Answer the following questions by giving reasons.**

1. Whether taking cough syrup by Robin is 'use'? Why?
2. Whether taking cough syrup by Raman is 'abuse'? Why?
3. Think about some other substances which are also abused by adolescents?

The table 2.1 gives the names and groups of drugs and their affects.

**Table 2.1**

Group	Drugs/Substances	Effect the user feels
Stimulants	Amphetamines (eg. Bensedrine, Dexedrine and Methedrine, cocaine, nicotine, tobacco	<ul style="list-style-type: none"> <li>Temporarily accelerate functioning of the brain (central nervous system) and the user may temporarily feel alert and full of energy.</li> <li>In higher doses, stimulants may lead to anxiety or panic.</li> <li>Mental health problems can occur with increasing use. In cases of serious overdose, death may occur.</li> </ul>
Depressants	Alcohol, barbiturates, e.g. Gardenal, tranquilisers like Valium.	Slow down activity of the brain and may also have hypnotic effects.
Sedatives	Hypnotics like Mandrax, Doriden	<ul style="list-style-type: none"> <li>Produce opium like effects and stupor. This group in short span may produce relaxing, but in higher doses, these may lead to drowsiness, decreased concentration, nausea, vomiting and sweating.</li> <li>Further increase in the dose may lead to deep sleep, loss of consciousness and even death.</li> </ul>
Narcotics/analgesics	Opium, morphine, codeine, heroin, brown sugar, synthetic drugs like Methadone, Pethidine, Mephadrine	
Cannabis Hallucinogens	<i>Bhang</i> (marijuana), <i>ganja</i> , <i>charas</i> , LSD (Lysergic acid Diethylamide) PCP (Phencyclidine), Mescaline, Psilocybin	Distort the way in which individuals normally see, hear and feel.

Following symptoms of drug abuse are noteworthy.

### Physical Symptoms

- Reddening and puffiness of eyes, unclear vision
- Running nose, congestion, coughing, pale face and dark circles under eyes
- Slurring of speech
- Nausea, vomiting and body pain
- Messy appearance, lack of cleanliness
- Drowsiness or sleeplessness, lethargy and passivity
- Loss of appetite, significant weight loss or gain
- Numerous fresh injection marks on body, blood stains on clothes, profuse sweating

**Behavioural Symptoms**

- Changing mood, temper tantrums, hostility
- Acute anxiety, depression
- Blaming, lying, making excuses, emotional detachment
- Loss of interest in studies, sports and in daily routine
- Impaired memory and lack of concentration
- Secrecy in respect of possessions and actions
- Loss of valuables or money from home

**Performance Symptoms**

- Withdrawal from family environment and non-participation in family work
- Sudden lowering of grades in school, non-completion of home work, absenteeism
- Presence of needles, syringes and strange packets at home
- More time spent in personal room, in the bathroom or away from home

Drug abuse in itself is not a cause of HIV and AIDS or other STIs, but under the influence of drugs, people may engage in risky behaviour that makes them more susceptible to these infections. Furthermore, substance abuse influences not only the individual but also the family and even the community. The person who gets addicted often loses interest in other activities be it school, job or any other responsibility. As a result, the addicts are not able to undertake their responsibilities and become a liability for their families. Furthermore, it is expensive to buy substances/drugs on a regular basis. Hence, in desperation, addicted individuals may be forced to engage in petty crimes.

There can never be any need for drugs if one leads a meaningful life with nutritious food, physical exercise, yoga, satisfying occupation and healthy relationships.

**2.8 SEXUAL HARASSMENT OR SEXUAL ABUSE**

Sexual harassment is described as any unwelcome sexual gesture or behaviour, whether directly or indirectly—physical contact or advance, showing pornography, a demand or quest for sexual favour, or any other unwelcome physical, verbal/nonverbal conduct. It also includes molestation and rape. It is a criminal act and a punishable offence. Young girls and boys often become target of sexual harassment/abuse by older and powerful people. As per the research, a person who is engaged in sexual abuse of young girls and/or boys is often known to them. Boys are equally vulnerable to sexual abuse. The black mailers usually threaten the youngsters of serious consequences if they tell anyone. In such cases, the girl/boy being abused must immediately inform parents/or any trusted member for protection.

**Box 2.5**

Saying 'No' with confidence is the only way to protect oneself from sexual harassment.

Read about Protection of Children from Sexual Offence (POCSO) Act 2012 and Discuss with your classmates

**ACTIVITY 2.6**

**Read the following case studies and discuss the questions with your friends.**

**Case Study 1:** Mohit is ten years old. His uncle often comes over to Mohit's house and stays over. He brings lots of toffees and biscuits for him. He always insists on sleeping in Mohit's room. At times he tries to touch Mohit in ways that Mohit does not like. Mohit's parents notice that Mohit has become very quiet and withdrawn but does not share anything with them.

**Questions for discussion**

1. Why do you think Mohit is uncomfortable with his uncle's behaviour?
2. What should Mohit's parents do when they notice that he has become very quiet and withdrawn?
3. Why do you think Mohit does not say anything to his parents?
4. Was Mohit's uncle abusing him? Explain your answer.

**Case Study 2:** Sabina and Monica study in Class XI and are friends. They go out to see a film. On the way out of the hall, they are teased and harassed by a man who passes obscene comments. Sabina wants to make noise about the incident and seek support from others around to confront the man and warn him. She also wants to complain to the cinema manager and insist that they act to make the hall safe for women. However, Monica is not sure of taking this stand. She feels that perhaps they should not go to cinema halls on their own to see films and should be accompanied by their parents or brothers who could protect them.

**Questions for discussion**

1. What do you think Sabina and Monica finally did? Why?
2. What would you have done if you were in Sabina's or Monica's place? Why?
3. Have you noticed, or heard of sexual harassment in cinema halls, roads, buses or other public places?
4. What can possibly be done to make public places safer for girls and women? Who all can make this happen? For example, cinema hall managers, police, sensitisation/awareness campaigns by schools, girls like Sabina and Monica themselves by supporting one another, etc.

**Case Study 3:** Reena is a 16 year old girl and she studies in Class X. A boy Hemant in her class has been stalking her for some time now. He has even proposed to her and she has refused his 'proposal'. However, the boy went on troubling her, saying that "When a girl says no, she means yes". Reena is very angry. She wants to tell her teacher, but is scared the teacher may not understand.

**Questions for discussion**

1. Why do you think Hemant makes the comment "When a girl says no, she means yes"? What do you think of the comment?
2. What advice would you give Hemant if he was a friend of yours?
3. What advice would you give Reena if she was a friend of yours?
4. Do you think the teacher could play a positive role, if told about the situation? If yes, how?

**Source :** NCERT, 2012 Training and Resource Materials : Adolescence Education Programme, New Delhi

## ASSESSMENT

### Answer the following questions

1. Give at least one difference between
  - (a) Growth and development .....
  - (b) Development and maturation .....
2. Given below are nine statements. Categorise them into events of Growth (G), Development (D) and Maturation (M).
  - (a) A baby on seeing his mother begins to utter the word "MA".
  - (b) The testis begins to produce sperms.
  - (c) The fetal heart begins to beat.
  - (d) A plant observed in the garden a few months ago is now a shrub.
  - (e) The baby starts walking without support.
  - (f) Aruna has reached menarche.
  - (g) Mary can no longer fit into her shoes that were bought for her last year.
  - (h) Haneef needs to shave everyday this year before going to school.
  - (i) In 2007, Dhruv was only 5 feet tall. On his 14th birthday, his height is 5 feet 10 inches.
3. List factors that affect growth.
4. The teenager should take nutritious diet, because.....
5. Arun is worried because he is not as tall as others in his class. How will you dispel such unnecessary anxiety?
6. Prepare a worksheet writing the response in following things.
  - (a) Who all would you include as a support system in case of any problem to be sexual harassment? Think of both people and institutions.
  - (b) Why have you included them people/institutions as a safety net?

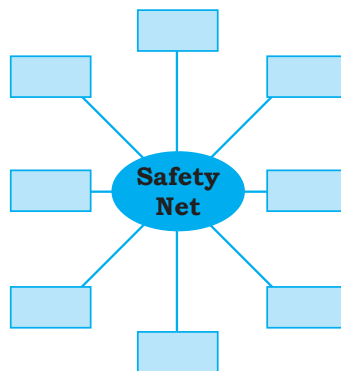



- 7. Why is psychological security necessary for a growing adolescent?
- 8. "Communication between parent and the adolescent child is critical for his/her health." Why?  
.....  
.....
- 9. Give at least two reasons of substance abuse by adolescents.  
(a) .....  
(b) .....
- 10. Why is it necessary to discard the myth that 'women are the weaker sex'? Give three reasons.  
(a) .....  
(b) .....  
(c) .....
- 11. In dealing with the following challenging situations whom should adolescents approach and why?  
(a) bullying  
(b) discrimination by grandmother  
(c) sexual abuse
- 12. "Growing up with confidence is not a myth." Explain
- 13. Write a paragraph in your own words why "growth" is necessary for all living beings including humans.
- 14. What is depression. Give three symptoms.
- 15. Explain the difference between drug abuse and use with the help of examples.

**PROJECT**

- 1. Organise a debate in the class on the topic "Growth is natural so all teenagers grow and behave in the same way".
- 2. Conduct a survey in your neighbourhood picking up 20 boys and 20 girls and prepare a report on their height and weight. How many are overweight? How many are under weight?
- 3. Why do you think that both boys and girls should be given equal opportunities in life? Give three arguments in favour.  
(a) .....  
(b) .....  
(c) .....
- 4. When heredity defines limits of growth and development, why bother about the environment? Give three arguments against this statement.  
(a) .....  
(b) .....  
(c) .....

# Physical Education

3



13149CH03

## 3.1 INTRODUCTION

The concept of physical education is generally understood as organisation of some games, sports or physical education activities in schools. There are schools where specific periods are allocated for this subject in the time table. It has been noticed that during such periods, most of the students are either left on their own to play the games in a way they like or they are taken to the field where they engage themselves in different sports without the guidance or supervision of teachers. In some schools, selected students play games like football, cricket, volleyball, hockey, basketball, and so on. Annual sports are organised, but again in such activities only

a few selected students participate. All these experiences taken together provide a basic understanding of the physical education as a concept. However, when we go into details of the aims, objectives and concepts of physical education, we learn that they go beyond these traditional beliefs.

## 3.2 PHYSICAL EDUCATION

As we know, education, particularly school education, aims at the holistic development of children. It provides students with opportunities to grow and develop as adults to be useful for the society. It is important for us to know that one of the most important requirements for growing into healthy adulthood is the physical growth which supports cognitive development. It is, therefore, necessary that all children get adequate opportunity to participate in free play, informal and formal games, sports and yoga activities. It is in this context that health has been made a significant component of the subject of Physical Education in the school education system of the country. The subject “Health and Physical

### Box 3.1

#### Definitions

##### 1. According to Webster’s Dictionary

Physical education is an integral part of education which gives instructions in the development and care of the body ranging from simple calisthenic exercises to a course of study providing training in hygiene, gymnastics and the performance and management of athletics games.

##### 2. Columbia Encyclopaedia

Physical education and training, is an organised instruction in motor activities that contribute to the physical growth, health and body image of the individual.

##### 3. Central Advisory Board of Physical Education and Recreation

defines Physical education as an education through physical activities for the development of total personality of the child to its fullness and perfection in body, mind and spirit.

Education” adopts a holistic definition of health within which physical education and yoga contribute to the physical, social, emotional and mental development of a child.

In view of the above, the meaning of physical education becomes a little different from what is commonly understood. Physical education comprises holistic education for the development of personality of the child to its fullest and perfection in body, mind and spirit through engaging in regular physical activities. Physical education through the medium of physical activities helps individuals to attain and maintain physical fitness. It contributes to physical efficiency, mental alertness and the development of qualities like perseverance, team spirit, leadership and obedience to rules. It develops personal and social skills among the learners and makes a positive impact on their physical, social, emotional and mental development. It also contributes to the total health of learners and the community. Physical education thus, can be defined as a subject that is not only focused on physical fitness but is also concerned with development of a number of skills, abilities and attitudes for leading a healthy lifestyle. It inculcates values like cooperation, respect to others, loyalty, self-confidence, winning with grace and losing with hope.

### 3.3 OBJECTIVES OF PHYSICAL EDUCATION

As discussed above, by now it may be clear to you that the aim of physical education is not only physical development but also to equip learners with knowledge, skills, capacities, values, and the enthusiasm to maintain and carry on a healthy lifestyle. It promotes physical fitness, develops motor skills and the understanding of rules, concepts and strategies of playing games and sports. Students learn to either work as part of a team, or as individuals in a wide variety of competitive activities. The main objectives of physical education are to:

- develop motor abilities like strength, speed, endurance, coordination, flexibility, agility and balance, as they are important aspects for good performance in different games and sports.
- develop techniques and tactics involved in organised physical activities, games and sports.
- acquire knowledge about human body as its functioning is influenced by physical activities.
- understand the process of growth and development as participation in physical activities has positive relationship with it.
- develop socio-psychological aspects like control of emotions, balanced behaviour, development of leadership and followership qualities and team spirit through participation in games and sports.

- develop positive health related fitness habits which can be practised lifelong so as to prevent degenerative diseases.

### ACTIVITY 3.1

1. Find out the following facts about your school and prepare a write-up.
  - Periods allocated for physical education in your school?
  - What do students do during physical education periods? How many students of a class actually participate in activities during such periods?
  - What type of knowledge is provided by the teachers about the concerned games and sports related skills?
  - What do the students do during these classes when they are left free?
2. Compare your write-up with the above objectives.
3. What will you do, if some of the objectives are not covered?

## 3.4 SCOPE OF PHYSICAL EDUCATION

Physical education has evolved as a multi-disciplinary subject over time and its scope is not confined to physical fitness and knowing the rules of games and sports. It includes many topics which belong to other subjects like science, biology, genetics, psychology and sociology. It is possible that all the contents that constitute the scope of physical education may not find a place in the syllabus meant for school education. However, it contains all the content areas as stated below.

### 3.4.1 Games and Sports as a Cultural Heritage

The games and sport activities that you play today have a strong linkage to our culture. Sport activities which dominate any region is embedded in the cultural milieu. Some of the sports that reflect the culture of a region of our country are *Kho-Kho*, *Kabaddi*, Archery, Lezim, Wrestling and so on. Our ancestors survived on hunting with the use of throwing stones as well as bow and arrows, running, jumping etc. were used for survival and recreation. Later when man became more civilised, it took the shape of competitive sports like athletics, wrestling, archery and so on. So, we can see a strong bonding of our culture in the present evolution of games and sports.

### 3.4.2 Mechanical Aspects in Physical Education

Physical education takes into consideration the mechanical aspects of various physical activities being performed. You are aware that the concepts regarding laws of motion, lever, force and its generation, maintenance of equilibrium, centre of gravity and its impact on movements, law of acceleration, speed and

### Box 3.2

#### Physical education consists of:

- games and sports as a cultural heritage
- mechanical aspects in physical education
- biological contents
- health education and wellness contents
- psycho-social content
- talent identification and training contents.

its development form important content areas of physical education. You will also study these aspects in your science textbook.

### **3.4.3 Biological Contents in Physical Education**

The contents drawn from the biological sciences take into consideration the areas of heredity and environment, growth and development, organs and systems, understanding of joints classification, and possible movements around these joints. In addition, muscles and their properties, effect of exercise on various systems of the body (like circulatory, respiratory, muscular, digestive and skeletal systems) are also linked to physical activities.

### **3.4.4 Health Education and Wellness Contents in Physical Education**

Physical education includes contents related to the area of health education through understanding the concept of hygiene, knowledge about various communicable and non-communicable diseases, problems relating to health and their prevention, proper nutrition and balanced diet. Community health, school health service programme, assessment of health status, prevention, safety and first aid for common injuries are also included in the scope of physical education.

### **3.4.5 Psycho-social Content of Physical Education**

Psycho-social aspect of physical education extends to the study of areas regarding individual differences, personality development, learning of various skills, motivation and its techniques, anxiety management, ethical and social values, group dynamics, cooperation, cohesiveness and learning. It also focuses on emotional development, relationships with peer/parents and others, self concept and self esteem.

### **3.4.6 Talent Identification and Training Content in Physical Education**

Physical education includes contents with regard to talent identification, development of components in relation to specific sport, understanding of various types of activities like aerobic, anaerobic, rhythmic and calisthenics. Training programmes, learning and perfection of various movements, sport skills, techniques and tactical patterns, warming up, load adaptation, recovery and cooling down are also a part of physical education.

## **3.5 TEACHING-LEARNING APPROACH**

We have, so far, discussed the importance of physical education as a subject area in the school curriculum. It is an integral part of Health and Physical Education which is prescribed as



a compulsory subject at the Primary (Classes/Grades I-V), Upper Primary (Classes/Grades VI-VIII) and Secondary stages (Classes/Grades IX-X) and as an optional subject at Higher Secondary stage (Classes/Grades XI-XII). But as you may be experiencing in actual practices, this subject has not been treated at par with other core subjects. It is not transacted satisfactorily in majority of schools. And wherever it is transacted, either some knowledge about games and sports is imparted or only a selected group of students are engaged in games and sports as extra-curricular activities.

Arguments like lack of the needed infrastructure and equipments, absence of trained teachers and paucity of time in schools are given as reasons for indifferent transaction of physical education. In fact most significant reason is the lack of appreciation of the relevance of this area for the holistic development of children by school authorities, teachers and parents.

### 3.5.1 Methodology of Teaching-learning

It is generally believed that the methodology of teaching learning is the concern of teachers only. Learners have little or nothing to do with it. But this is not true. The teaching-learning methods are concerns of learners as well. Knowing and understanding that how different subjects are taught are important for the learners of all subjects, but it has more relevance for the learners of physical education. When we

talk about you as learners of physical education, we mean that you have actually participated in the subject area, rather than merely studied it. It needs a suitable learning environment and a positive will for participation. As you now know, physical education does not mean organisation of a few sports and games activities, involving only a selected number of students, and that too occasionally. The following points are significant for the appreciation of this subject and the need for adopting appropriate teaching – learning methodology:

- Physical education is necessary to ensure participation of all children in free play, informal and formal games and sports activities. All students must be involved in health and physical education activities. Those who choose to excel in games and sports need to be provided adequate opportunity.
- Involvement of all learners means that even those students need to be involved, who are at the risk of marginalisation, for instance, who are differently abled. Such involvement will empower them to overcome the

### Box 3.3

- (i) Why do you feel that it is important for students to know how physical education activities are organised in school?
- (ii) Should the focus of physical education be only on selected students or for all? You can also discuss with your classmates.
- (iii) Seema is a differently abled girl and is on a wheelchair in the playground. What will you do to involve her in the game you are playing?

sense of helplessness, inferiority and stigma. Differences between students must be viewed as resource for supporting learning rather than as a problem. Inclusion in education is one of the components of inclusion in society.

### 3.5.2 Physical Education Cards (PEC) Methodology

Various methodologies are being employed and efforts are on to develop innovative teaching-learning methodologies, one such methodology known as PEC-India Methodology has been developed. It is the outcome of a joint initiative of the British Council and the Ministry of Human Resource Development, Government of India. Other international organisations, United Nations International Children Emergency Fund (UNICEF) and U.K. Sports were also involved. To begin with, this was developed for the primary stage and it was scientifically tried out in schools. The tryout has proved its effectiveness. Based on this experience, the Physical Education Cards (PEC) and Teachers' Manual have been developed for the upper primary and secondary stages as well. Moreover, this methodology has also taken care of the needs of differently abled children. They should also be involved in physical education. The notable features of this methodology are as follow:

- (i) It ensures that every student participates in physical education activities equally. Each card provides essential information needed for engaging all students of a class in the selected game or activity, even though the class has larger number of students;
- (ii) Teachers as well as students have material in the form of cards that can be conveniently handled and used for a longer time and in a better way.
- (iii) The cards will not only facilitate the organisation of activities but also make it more convenient for the teacher as well as students to comprehend the concerned vocabulary as well as pedagogical tools to organise games, sports and activities and provide equal opportunity to every student to participate in these; and

### ACTIVITY 3.2

You must have observed some students not participating in physical education activities including sports in your school. Discuss with them and your peers how to ensure their participation in physical activities, individual and sports.

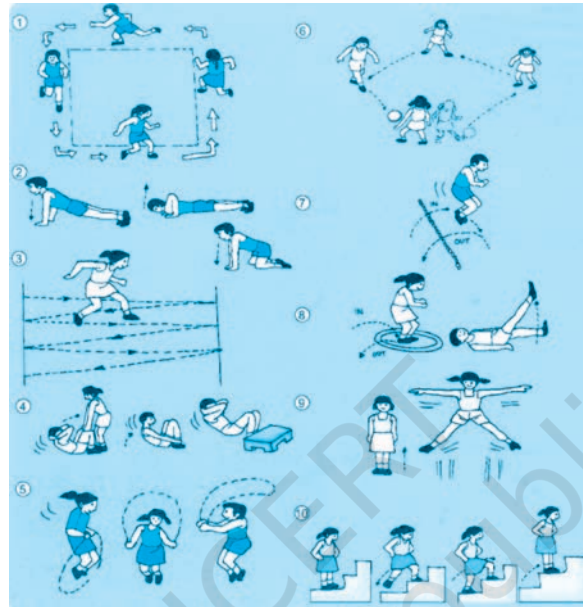

Fig.1 : Special child playing with bat

**ACTIVITY 3.3**

Prepare one Physical Education Card for any sport of choice in group.

- (iv) Each card mentions how the impact of activities conducted according to the process explained in it will attain the objectives of Health and Physical Education and how the achievements of students may be evaluated.



*Let's get fit*

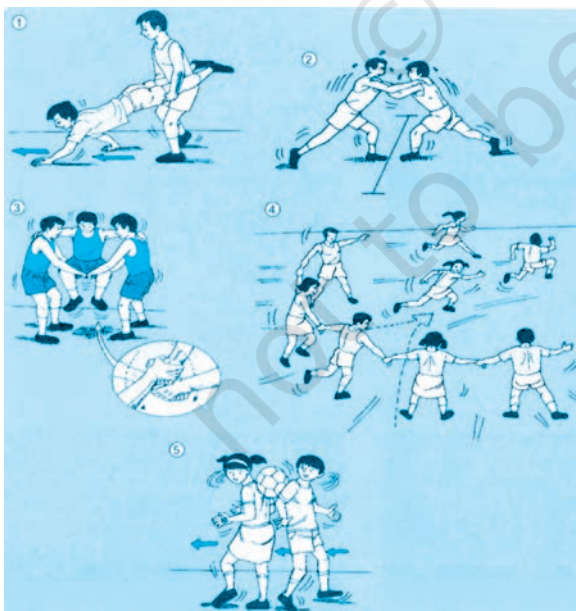

*Lead up games for Kabaddi*

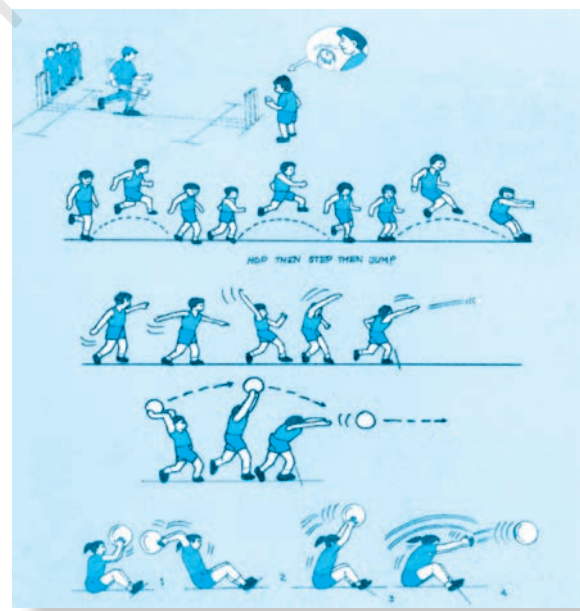

*Track and field events*

**ASSESSMENT****Answer the following questions**

1. Define physical education and discuss its main objectives.
2. What is the scope of physical education?
3. Describe a process that can ensure equal participation of all students of a class in a game of your choice.
4. Prepare a report on the actual implementation of health and physical education in your school.
5. How the community and its sources can be used for promoting health and fitness of children?
6. A teacher is regularly training 11 students for playing cricket. Do you think, the teacher is working towards the attainment of physical education objectives? Give adequate reasons for your thinking.

**Fill in the blanks**

- (i) Physical education has evolved as a multi..... subject.
- (ii) All children should get .....to participate in games.
- (iii) Through physical education activities .....of a child is developed.
- (iv) Physical education subject is at.....with other subjects.

**Tick (✓) mark either Yes or No**

- (i) Agility, balance and coordination are fundamental movement skills that are developed through participation in games and sports. (Yes/No)
- (ii) PEC means Physical Education Codes (Yes/No)
- (iii) Physical Education has been made a compulsory subject from Class I-X. (Yes/No)
- (iv) Yoga is an integral part of Health and Physical Education Subject. (Yes/No)
- (v) PEC ensures that every child finds equal opportunity to play game and sports. (Yes/No)



# Physical Fitness



13149CH04

## 4.1 INTRODUCTION

Physical fitness is one of the core preconditions of health. We cannot imagine a person to be healthy without being physically fit. Physical fitness, therefore needs to be appreciated in full measure. The common perception of physical fitness is the absence of ailment. If individual is not suffering from any perceptible disease, then he is considered physically fit. Is it true? Another significant issue is whether there is a universal condition of physical fitness which is uniformly applicable to all. It is not so. Physical fitness of young people is different from that of the aged. The physical fitness of a sports person is different from that of the persons working in army factory or a layman. In fact, physical fitness means different things to different people. In this lesson, let us discuss various aspects of physical fitness.

## 4.2 PHYSICAL FITNESS AND ITS IMPORTANCE

In earlier classes, physical fitness has been defined as the capacity of a person to carry out the daily activities without undue fatigue. Physical fitness is considered as a measure of the body's ability to function efficiently and effectively during work and leisure activities. In order to remain physically fit and healthy, we need to engage ourselves in physical activities and take measures for physically fit.

Physical fitness is an important area of discussion as the number of childrens becoming obese. The normal physical activities, which were done in earlier times both at home and outside as part of day-to-day routine have reduced due to development of science and technology. The work that was done manually is now being carried out by machines. The use of automated equipment such as automatic machines, remotes, mobiles and changes in lifestyles affect health and physical fitness. It has become a matter of deep thinking for all of us.

Now a days we find increased marketing of packaged food and diet for physical fitness. Many such health products now are advertised on TV and radio, and in newspapers, booklets and magazine. It is important for all of us to understand that physical fitness cannot be achieved without doing physical exercise regularly. We should not resort to any shortcut that

### Box 4.1

Physical fitness is the body's ability to function efficiently and effectively in work and leisure activities. Optimum efficiency is the key to physical fitness.



is frequently advertised in the media these days to achieve fitness or maintain balance in life style. Moreover, these products may have side effects in our daily life.

### 4.3 NEED OF PHYSICAL FITNESS AND WELL-BEING

As discussed in the first chapter on Health and Diseases, the benefits of being physically fit for the individual are manifold. The quality of life of an individual improves when he/she consciously adopts healthy lifestyle which promotes physical fitness as follows:

#### 4.3.1 Physical fitness

- improves the functioning of heart and lungs by increasing the availability of oxygen to all tissues and organs in the body system;
- improves muscle tone;
- promotes the development of good posture, proportionate figure, and thereby positive body image and physical appearance;
- ensures quick recovery after injury and illness;
- decreases the risk of cardio-vascular disease; (like Heart attack, Asthma etc.)
- reduces and controls undesirable body fat. When the individual does exercise, takes proper diet that also fulfils nutritional requirement, it helps maintain ideal body weight;
- increases energy level of a person;
- improves the mood by reducing depression and anxiety;
- postpones fatigue and reduces recovery time after vigorous activity; and
- helps people to meet challenges of life, makes them self-confident and delays the ageing process.

Being physically fit is important for all the age groups. To live better life to the fullest and enjoy all the opportunities, one try to be physically fit.

Physical fitness is essential for each and every individual at all stages of life. To achieve fitness, various modes and methods are available. Before adopting such methods, warming up before activities and cooling down after activities are essential to minimise any risk of injuries of an every individual.

### 4.4 COMPONENTS OF PHYSICAL FITNESS

Physical fitness can be classified into health related fitness and skill-related fitness. The health-related components are:

#### ACTIVITY 4.1

Collect information from people of different age groups living in your home and neighbourhood about their physical activities that they performed regularly.

Inquiry and record from them, what do they understand by physical fitness.

Analyse their relationship of physical activities and physical fitness.

(i) Cardiovascular Fitness, (ii) Muscular Strength, (iii) Muscular Endurance, (iv) Body Composition and (v) Flexibility. The skill-Related Fitness Components are: (i) Agility, (ii) Balance, (iii) Neuro Muscular Adaptations and Coordinative abilities, (iv) Speed, (v) Strength, and (vi) Reaction Time.

#### 4.4.1 Components of Health Related Fitness

**Cardio-respiratory Endurance:** Cardio-respiratory endurance reflects the ability of the body's circulatory and respiratory systems to supply fuel during sustained physical activity. To improve your cardio-respiratory endurance, try activities that keep your heart rate elevated at a safe level for a sustained length of time such as walking, running, jogging, swimming, bicycling etc. The activity you choose need not be strenuous enough to improve your cardio-respiratory endurance. Start slowly with an activity you enjoy, and gradually work up increase to a more intense pace.

**Muscular Strength** is the amount of force applied on muscle or muscle groups, is able to exert for one maximal effort (contraction). The key to making your muscles stronger is working them against resistance, whether that be from weights or gravity. If you want to gain muscle strength, try exercises such as lifting weights (under proper supervision).

**Muscular Endurance** is the ability of a muscle or muscle group to exert force against a submaximal load for a given length of time (or number of repetition) before fatiguing to the point of failure.

**Body Composition** refers to the proportion of total body mass to body fat, it includes amount of muscle, fat, bone, and other vital parts of the body. Body composition is important to be considered for health and managing the body fat.

**Flexibility** is the range of motion around a joint. Good flexibility in the joints can help prevent injuries through all stages of life. If you want to improve your flexibility, try yoga, gymnastics and basic stretching exercise programme.

#### 4.4.2 Components of Skill-related Fitness

**Agility** is the ability to change and control the direction and position of the body while maintaining a constant, rapid motion. For example changing directions to hit a tennis ball.

**Balance** is the ability to control or stabilise the body when a person is standing still or moving. For example, handstand in gymnastics.

**Coordination** is the ability to use the senses together with body parts during movement. For example, dribbling a basketball. Using hands and eyes together is called hand-eye coordination.

### Box 4.2

#### Body Mass Index (BMI)

It is an estimate of an individual's relative body fat. It is calculated by measuring his/her height and weight using the formula; body weight in kgs/ height in metre squared (m)<sup>2</sup>.

## ACTIVITY 4.2

Find out your BMI

Take your body weight in kgs and height in metres. Divide your weight by the square of height to obtain your BMI.

Using the following norms, ascertain where you stand.

$$\left( \frac{\text{weight in kgs}}{\text{Height in metres}^2} \right)$$

Below 18.5 kg/m<sup>2</sup> - Underweight

Between 18.6 kg/m<sup>2</sup> and 23 kg./m<sup>2</sup> - Normal

Between 23.1 kg/m<sup>2</sup> and 30 kg./m<sup>2</sup> - Overweight

30 kg/m<sup>2</sup> - obese

Also select randomly five students of your class and calculate their BMI.

**Source:** [www.360living.in/article/body-mass-index-bmi](http://www.360living.in/article/body-mass-index-bmi).

The Indian health ministry has set new diagnostic cut-off for the body mass index as 23 as opposed to 25 globally, makes healths norms tighter.

**Speed** is the ability to move your body or parts of your body swiftly. Many sports rely on speed to gain advantage over opponents. For example, a Basketball player making a fast break to perform a lay-up, a tennis player moving forward to get to a drop shot, a football player running the defense to receive a pass.

**Power** is the ability to move the body parts swiftly while applying the maximum force of the muscles. Power is a combination of both speed and muscular strength. For example, volleyball players lifting up to the net and lifting their bodies high into the air.

**Reaction Time** is the ability to reach or respond quickly to what you hear, see or feel. For example, an athlete quickly coming off the blocks early in a swimming or track event, or stealing a base in baseball.

## 4.5 ACTIVITIES FOR DEVELOPING PHYSICAL FITNESS

The type of activities that may be useful to different aspects of fitness are aerobic and anaerobic. These are as follow:

### (a) Aerobic Activity

**Aerobic Exercise:** any physical activity that requires increased oxygen is an Aerobic exercise. Aerobic activity or exercise is therefore the same as cardiovascular exercise as it

- increases cardiac capacity
- strengthens the heart and lungs

Aerobic fitness is the capacity of an individual to sustain exercise for a prolonged period of time, for example jogging for more than 15 minutes, cycling and calisthenics etc.

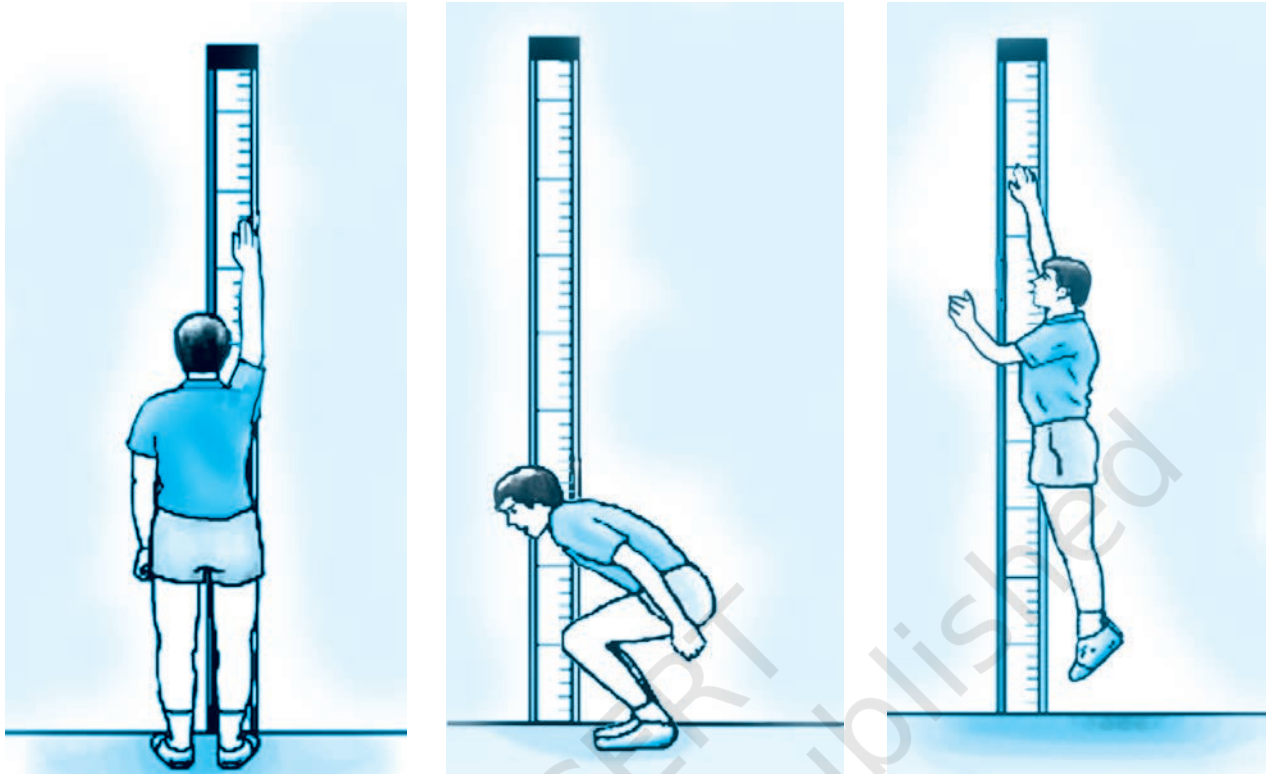

Fig. 4.1 : Vertical Jump Test to Measure Power

### ACTIVITY 4.3

#### Vertical Jump Test to Measure Power

- Stand facing a wall and reach up with your hand closest to the wall.
- Keep your feet flat on the ground and mark the point of the fingertips that may be recorded. This is called the standing reach height as shown in Fig. 4.1.
- Stand away from the wall and leap vertically as high as possible using both arms and legs to assist in projecting the body upwards.
- Attempt to touch the wall at the highest point of the jump.
- Find your score. The difference in distance between the standing reach height and the jump height is the score.
- Do it three times. The best of three attempts is your final score.

Aerobic activities develop the cardio-respiratory endurance of an individual. The different types of aerobic activities are aerobic dance, skipping, walking, long distance running, swimming, etc.

#### (b) Anaerobic Activity

The term Anaerobic means “without oxygen”. Anaerobic exercise is a high intensity activity for a short period of time. It relies on energy sources that are stored in the muscles of individuals.

### ACTIVITY 4.4

**Case:** The football coach assesses the fitness of players of his team by making each of them run five lengths of the football field. One length of the field is 144m. He then makes a chart with the following parameters to assess the speed of each of his players.

Average speed=Distance/Time

Players	Time in seconds to cover 5 lengths of the field	Distance in metres	Average Speed= Distance/Time
Player 1	5 min 20 sec (60 sec × 5) +20=320 sec	144 × 5=720 m	720/320=2.25 m/s
Player 2	4 min 10 sec	720	
Player 3	6 min 10 sec	720	
Player 4	6 min 10 sec	720	

Work out the average speed of players 2,3 and 4. Speed of player 1 is already calculated for you.

- You and your friends may try to find out your speed in the same way by running known lengths of an open field in your neighbourhood.

Repeat the activity for seven days and work out your average speed. Before starting this activity, measure one length of the field.

Anaerobic exercise develops stronger muscles. With vigorous workouts, there is temporary shortage of oxygen being delivered to the working muscles, for example sprinting or body building.

However the early stage of all exercise is anaerobic.

This kind of activity is responsible for developing speed. This form of activity benefits the bones, i.e. their thickness increases. The different types of anaerobic activities are weight lifting, sprint races, jumping, mountain climbing, rafting etc.

#### (c) All Team Games and Individual Sports

All major games and individual sports require a certain level of fitness components like strength, speed, agility, flexibility and endurance for successful participation.

##### 4.5.1 Warming Up and Cooling Down

Warming up is usually performed before participating in any games and sports and physical activities. It is important to keep oneself free from injury, pain and how to avoid fatigue. While warming up prepares your body for intense exercise, whereas cooling down helps bring it back to near normal after rigorous activity.



**Box 4.3**

Aim of warm-up is to prepare the mentally and physically fit student.



1. Head tilt (side to side)

**Warming Up:** Muscle stiffness is thought to be directly related to muscle injury and therefore, the warming up should be aimed at reducing muscle stiffness.

Warming up should consist of a gradual increase in physical activity for individuals for increasing joint mobility, stretching and various ways of sports related activities.

- One should warm-up approximately 8-12 minutes or per specific requirements which include running, stretching of wrists, elbows, shoulders, neck, trunk, hip, knees, ankles joints.

**Cooling Down:** Once you are through with the workout and you reach the end of the game, it is equally important to ensure that the body cools down.

Cooling down should ideally consist of:

- five to ten minute walk or light jog as it cools down the body temperature and relaxes the muscles.
- about ten minutes of static stretching exercises that include chest stretch, biceps stretch, hamstring stretch, calf stretch, hip and thigh stretch, front of trunk stretch and quadriceps stretch. Each stretch should not take more than 10 to 30 seconds.

Intensity and duration of warming up and cooling down should vary according to the nature of workout or game. The more rigorous the workout or game, the more rigorous should be the warm up and cool down.

#### Benefits warming up and cooling down

Warming Up	Cooling Down
Warming up is a low intensity dynamic exercise and static stretch performed to gradually prepare the body for further exercises and to prevent damage to skeletal muscles connective tissue and heart.	Cool down exercise used to prevent rapid drop in arterial blood pressure. After completion of vigorous exercise, the person should move for few minutes until his/her breathing come down to near normal.

# ASSESSMENT

### Answer the following questions

1. What is meant by physical fitness?
2. What are the major components of physical fitness?
3. What is the difference between speed and strength?
4. Why well-being cannot be achieved without physical fitness?
  - (a) .....
  - (b) .....
5. What happens if an individual ignores warming up and cooling down for the workout?
 

.....

.....

.....

### Fill in the blanks

- (i) Ability to exert maximum force of contraction in minimum possible time.....
- (ii) Greatest amount of force a muscle or muscle group can exert in a single effort.....
- (iii) Performance of repeated movements with a sub-maximal force for an extended period of time.....

### Tick (✓) mark either Yes or No

- (i) Health and physical fitness are synonymous.(Yes/No)
- (ii) A physically fit person can carry out physical tasks for longer duration without fatigue. (Yes/No)
- (iii) Body composition is a health related physical fitness component. (Yes/No)
- (iv) Agility and coordination are skills related to physical fitness components. (Yes/No)
- (v) Vertical jump helps to measure flexibility. (Yes/No)

### ACTIVITY 4.5

1. List the activities which are generally done by you and your peers for physical fitness.
 

Aerobic	.....	.....	.....
	.....	.....	.....
Anaerobic	.....	.....	.....
	.....	.....	.....
2. Write how often do you engage yourself in the above mentioned activities and their effect on your total health.

# Sports Training

5



13149CH05

## 5.1 INTRODUCTION

We use the term training in various contexts. We talk of training of teachers, administrators, police and army personnel, medical and paramedical functionaries including, working in non-governmental organisations and volunteers engaged in various events. In these contexts, by training we mean, an organised and systematic instructional process which aims at improving an individuals' ability to play their assigned roles effectively and meaningfully. However, this kind of understanding of the term training cannot be applied to the concept of sports training. The term sports training is specifically used in the context of athletics, sports and games which could be a training of sports persons, coaches and teachers of physical education. It is also used by scientists and experts who belong to the field of sports science and medicine, sports bio-mechanics, exercise physiology, sports psychology and other fields like yoga and science movement. But even in these contexts, the concept of sports training is understood differently. In this chapter, therefore, we shall learn the meaning of sports training, its aims, characteristics and principles and also about sports skills.

## 5.2 SPORTS TRAINING: MEANING

Sports training is a special process of preparation of sports persons based on scientific principles aimed at improving and maintaining higher performance capacity in different sports activities. It is a particular type of training designed to improve fitness and abilities to perform in a given sport. It includes strength in training, corrective and restorative exercises, conditioning and cardiovascular training. It also includes mental and psychological training and advise on nutritional values.

## 5.3 PERFORMANCE DEVELOPMENT THROUGH SPORTS TRAINING

Sports training is especially focused on optimal performance in a particular sport. Its main aim is to develop the performance capacity of sports persons, so that they achieve the highest possible performance. To do so, it is essential to be mentally strong. The ability to manage stress and anxiety associated with different sports need to be strengthened. Competition in sports makes the participants face varied situations which require the individuals to be mentally fit.

### Box 5.1

Purpose of sports training is to achieve optimal level performance in a particular game and sport.

## 5.4 OBJECTIVES OF SPORTS TRAINING

The main objectives of sports training are as follows.

- 1. Improvement of physical fitness:** The performance in sports generally depends upon physical fitness of a sports person. Every sport activity needs specific type of physical fitness, and hence, the improvement of various components of physical and skills related fitness like strength, speed, coordination, endurance and flexibility is an important aim and objective of sports training.
- 2. Acquisition of sports skills:** This includes motor skills as well as basic movement skills. Fundamental motor skills are prerequisites to the learning of sport-specific skills. Every sports activity requires to observe certain specific movement procedure to tackle a particular task. This movement procedure is known as technique and when this technique is learnt and perfected, it leads to skill development. Whenever sports persons include in technical training, they focus on acquisition of motor skills relevant to a particular sport. Fundamental motor skills such as hopping, jumping, skipping, kicking, throwing, catching and striking are prerequisites to the learning of sport specific skills of basketball, football, gymnastics, tennis, cricket, badminton etc.
- 3. Improvement of tactical efficiency:** Tactical training is designed to improve various strategies and is based upon analysis of the tactics of opponents. Specific training in sports helps the sports persons to make the best use of their abilities and techniques so that the chances of success in competition are increased. The training develops three kinds of tactics: offensive, defensive and high performance tactics. Tactical efficiency is enhanced by providing the sports persons with knowledge of rules and repeated opportunities to perfect tactical abilities in them.
- 4. Improvement of mental abilities** are critical for high level performance in any sport. The training aims at development of positive attitude towards sports and competition, dedication and devotion towards particular sport or event, sincerity and honesty, self-confidence and optimum level of aspiration.

## 5.5 CHARACTERISTICS OF SPORTS TRAINING

Some of the important characteristics of sports training are:

- 1. Sports Training is Individual-specific:** The needs of every individual for performing in a particular sport are different from those of another. If we take the example of the sprint event, even a small difference in time and speed or distance decides the performance record, victory

### ACTIVITY 5.1

Discuss with your classmates the offensive, defensive and high performance tactics that are required to be adopted by any team game of your school, which may be participating in some competition. Based on the discussion, prepare a list of three kinds of tactics, offensive defensive and high performance.

or defeat. The difference depends on individual-specific capabilities. It is, therefore, necessary to identify the individual potential during the training. By identifying their needs, training may be focused at improving the identified gaps in the abilities of that sports person.

2. **To Achieve High Performance in a Sports Competition:** The important feature of sports training is its focus on enabling the sportsperson to achieve the highest possible level of performance in any of the sports competitions. It is a process which is spread over a long period of time.
3. **Sports Training is a Scientific Process:** It is highly influenced by the scientific methods, to achieve best result the knowledge from various dimensions of sciences has to be incorporated during the process of training.
4. **Coach has an Important Role:** A coach helps in building confidence, boosts morale and acts as a friend and a mentor. A coach is like a 'philosopher and mentor' on the sports field.
5. **Optimum Development of Sports Persons:** To achieve optimum performance sports training should be planned, systematic and scientific and to achieve same, different means and methods are used. These means and methods are constantly modified and used in different conditions. Sports, training is a continuous process for optimum development and perfection of sports persons.
6. **Sports training is an Educational Process:** Sports training is basically an educational process and it develops all the aspects of personality. High performance is not possible without developing the personality because both aspects are inter-related and inter-dependent of sports training.
7. **Sports training is a Process of Development of Hidden Talent:** The training helps in observing and assessing the performance level of the player at any given moment. While doing so the hidden talent in a sportsperson is identified. This talent is systematically nurtured through the required specific training inputs.

## 5.6 METHODS OF SPORTS TRAINING?

There are various methods of sports training that are mentioned below:

- Continuous Training Method
- Interval Training Method
- Circuit Training Method
- Plyometric Training Method



- Repetation Training Method
- Weight Training Method
- Fartlek Training Method
- Cross Training Method

However in this chapter only two methods are described:

- 1. Interval Training:** It involves maximum intensity work with intervals. This intensity work is alternated with periods of rest or low activity so that the body adjusts to work and rest. This method involves more of cardiovascular activities of individual.
- 2. Cross Training:** refers to training in different ways to improve the overall performance. Cross training uses different methods collectively to improve fitness and increases effectiveness of the training process for every human.

## 5.7 PRINCIPLES OF SPORTS TRAINING

It is important to know the basic principles that must be reflected in sports training. These are:

- 1. Continuity of Training:** which is the key to ensure the best outcome in a sport. The training of the sports persons has to be continuous and regular. Hence, too long a break in the training should be avoided and the condition of optimum load should be created.
- 2. Increasing the Training Load:** there is a relationship between the load and adaptation process. Training load should be gradually increased to enable the body, to adapt higher demands progressively.
- 3. Active Participation:** It is a well known fact that a player who is passively engaged in the training does not develop abilities and always remains totally dependent upon the coach or the physical education teacher and never develops confidence or improves performance capabilities. Therefore the teacher/coach must ensure that the sports persons participate in the training with conviction and sincerity.
- 4. Planned and Systematic Training:** To achieve a high level of sports performance in competitions, the training must be well planned and conducted in a systematic manner for better results.
- 5. General and specific training:** Both general and specific training of a sports person are equally important because general training creates the base and specific training helps to achieve high performance. General training needs to general conditioning of the body such as developing strength, speed, endurance, flexibility, agility, balancing, ability in general. General training is done by general exercising for the development of all

### Box 5.2

Load is defined as the amount of work done by an individual's body. It is the psychological and physiological demand put on the body parts through motor stimuli resulting in improvement and maintenance of higher performance capacity.

### Activity 5.2

Observe the sports training sessions planned and conducted by the coach/physical education teacher in your school. Write a brief report on the basis of your observations. Indicate whether all the principles of training are followed. Point out the missing ones, if any in text.

the muscle group of the body whereas specific training consists of specific exercises with the aim to develop specific strength, specific muscle group and specific motor abilities required for a particular sport.

6. **Clarity** with respect to all aspects of the concerned sport and games more importantly, its techniques and tactics for performance enhancement is the key.
7. **Cyclicity:** The training can be organised in three different cycles: *Macro cycle*: having duration of 3–12 months; *Meso cycle* of 3–6 weeks; and *Micro cycle* of 5–10 days.
8. **Ensuring results:** Sports training is planned to achieve the expected results in small and major competitions or tournaments.
9. **Critical training load:** The training load may be increased to meet the higher demands of competition in unforeseen situations. The training load should be managed more than the general load. This critical load should be measured 4–5 times in a year.
10. **Adaptability:** The adaptability to the training load should be in proper proportion between the load and recovery. Then only a sports person gets adapted to the training load.
11. **Uniformity and differentiation:** The uniformity may be in terms of time and duration of the activity, whereas, the load may vary as per the capacity of the individual sportsperson. It is an established fact that no two individuals are alike. The sports persons participating in the training are different in terms of age, health condition, individual capacity, recovery pace and physique. Keeping these factors in view, the training must be planned as per the needs of the individual sports person.
12. **Feasibility:** training of the sports person should be planned and conducted to draw the maximum benefit. Too little or too much training needs to be avoided.

## 5.8 TRAINING LOAD

As is evident from the above, in sports training, the load is a major concern. Efforts should be made so that possible work can be done with minimum effort. Load is defined as the amount of work done by an individual's body. It is the psychological and physiological demand put on the body parts through motor stimuli resulting in improvement and maintenance of higher performance capacity. Sports training consists of physical exercises. Therefore one needs to be aware

of how much training load helps to stimulate various organs of the body, so that the maximum benefits can be achieved.

### 5.8.1 Over Load

During training of sports persons, load is given to the players according to their capacity. Whenever this load goes beyond the capacity of an individual, the physiological and psychological functions get disturbed. Though this increased load does not affect the sports person immediately, if the administration of the overload continues for a longer period, it results in decrease of his/her performance. The important signs and symptoms of over load are: (i) fatigue, (ii) decline in performance, (iii) loss of interest in sports, (iv) loss of concentration, (v) lack of motivation, (vi) sleep disorder and (vii) loss of appetite (viii) prone to injuries.

### 5.8.2 Adaptation Process and Training Load

Adaptation is defined as the adjustment of physical and psychological functional systems to the training load. Adaptation to a load results in the enhancement of performance capacity. Thus, a sports person is able to increase his/her performance as a result of adaptation process. Adaptation process demands that a sports person maintains regularity in training. If a sports person is exposed to new and unfamiliar load in a systematic planned way the adaptation process will be faster.

## ACTIVITY 5.3

Discuss individual experience of members of the team of your school, who play either Volleyball, Kho-Kho, Football or any other sport and who are trained by the physical education teacher/coach.

**Some discussion point could be:**

- (a) What type of training method is being practised?
- (b) How the training load was increased?
- (c) Did they feel that the increase in training load improved their performance?
- (d) Did they feel comfortable with the increase in the training load?
- (e) Did anyone get injuries because of the increase in the training load? If yes, what kinds of injuries they got?

Note down their answers, prepare a report based on their answers and share the report in your class.



## ASSESSMENT

**Answer the following questions.**

1. What is the meaning of sports training?
2. Why is it essential to train a sports person systematically?
3. List and explain the principles of sports training.
4. Explain the terms training load and adaptation.
5. Why a long break in sports training should be avoided?
6. What is the difference between interval training and cross training?

**Fill in the blanks.**

- (i) Sports training is a .....process.
- (ii) Sports training aims at high performance in .....
- (iii) Adaptation of the training load takes place only when the load is.....continuous process.

**Tick (✓) mark either Yes or No.**

- (i) Sports persons are trained on the basis of scientific principles. (Yes / No)
- (ii) Sports training does not help improve the sports performance. (Yes / No)
- (iii) Sports training requires systematic planning. (Yes / No)
- (iv) Learning of sports skills is the result of practice and experience. (Yes / No)
- (v) In sports training, coach/physical education teacher does not have a prominent role. (Yes / No)

# Individual Sports

## 6



13149CH06

### 6.1 INTRODUCTION

Games and sports in some form or the other have been a part of human life either for survival or for pleasure. Gradually human beings started organising events including games and sports as community events. Consequently, the need was felt to acquire specific skills and advancement in many sports. Each sport has its specific skills which need to be developed for playing correctly. In this chapter we are going to discuss how some individual sports have evolved and how to develop proficiency in playing these sports. Rules and regulations of these sports are revised from time to time by their federations.

#### Box 6.1

It is important to note that playing any sport:

- strengthens heart muscles;
- reduces hypertension;
- helps in keeping optimal weight as per height; and
- helps in preventing of bone related disorders.

If played at least for 30 minutes a day after adequate warming up it keeps you feeling strong, motivated, stress-free, having high self-esteem and induces better sleep at night.

### 6.2 BADMINTON

Badminton is a game which is played by men, women (Singles/Doubles) and both men and women (Mixed Doubles) together. It can be played by persons of all ages. The first set of rules were formulated in Pune, in India in 1901. These rules were gradually adopted by other nations. Due to this reason, it is believed that badminton originated in India. However, the game became an international sport after the first All England Championship. In 1934, the International Badminton Federation (IBF) was formed and the rules of the game were standardised. World Badminton Federation (WBF) regulates the game. Badminton Association of India came into existence in 1934 and various State Badminton Associations are affiliated to it.

#### 6.2.1 Types of Events

- Singles (boys, girls),
- Doubles (boys, girls),
- Mixed Doubles (Combination of a boy and a girl)

#### 6.2.2 Facilities and Equipment

- For playing badminton, a racket, net and shuttle cock are required.
- **Court measurements:** The length and width of the doubles court shall be of 13.40m × 6.10m. The height of the net is 1.55m at the sides and 1.52m at the centre.

#### ACTIVITY 6.1

Collect information about your favourite Badminton player national/international and which aspects of his/her game do you like?



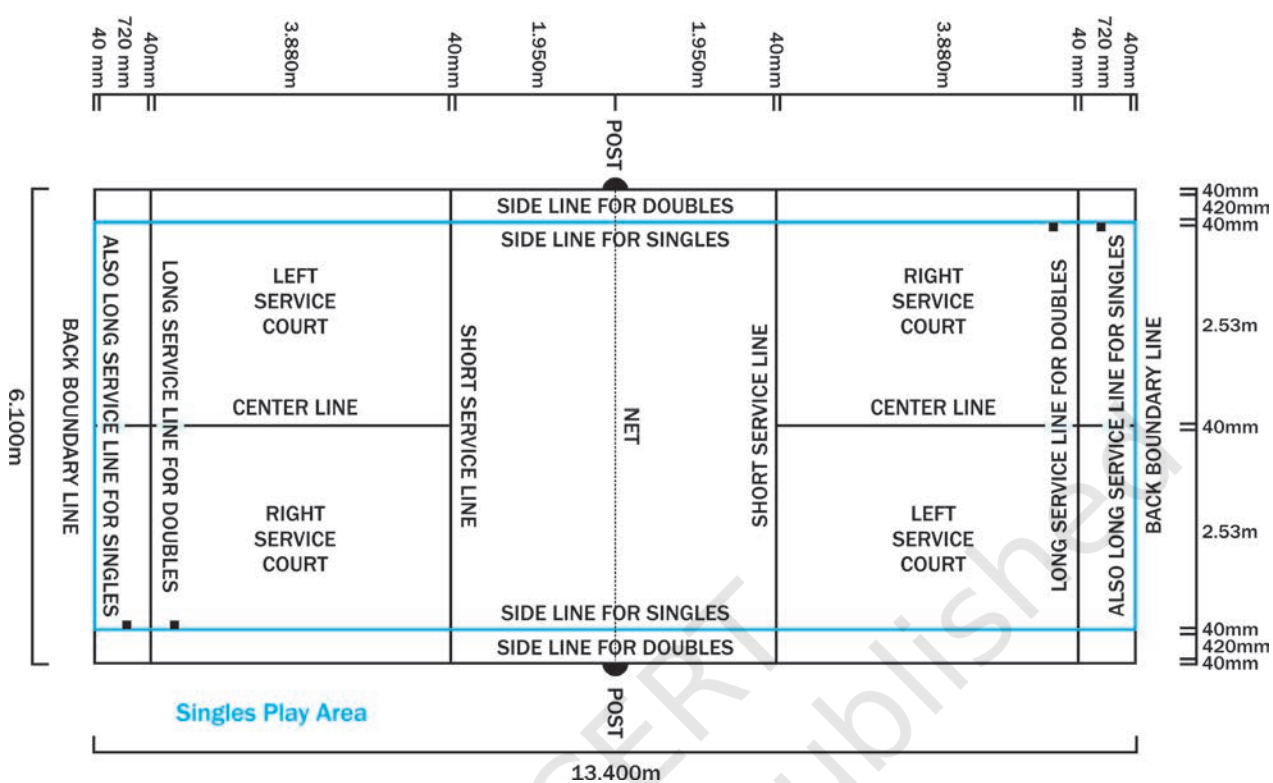

Fig. 6.1 : Badminton Court

### 6.2.3 How to Play Badminton

In singles, there is one player on each side and in doubles, there are two players on each side.

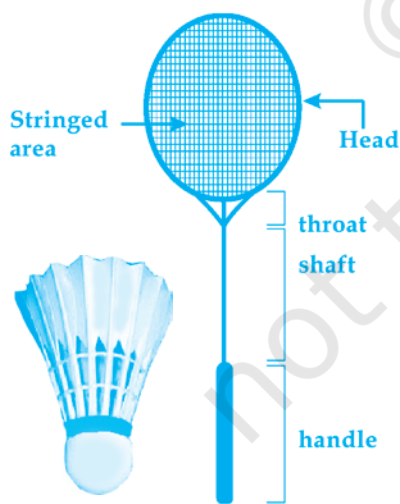

Fig. 6.2 : A Racket and a Shuttle

- The game begins with a toss and winner of the toss has the choice either to serve or to receive to serve or opt any side of the court to start the game.
- Each player has to serve from alternate sides of the court and winner of each rally will get one point.
- A standard game consists of 21 points with a two point difference.
- The side winning a game, serves first in the next game.
- Server and receiver stand in diagonally opposite service courts and the shuttle must be hit below the waist.
- The shaft of the racket must be pointing in the downward direction with both feet in contact with the surface of the court until service is delivered.
- A 'let' is called when a rally is stopped without any point. A let may be given, if:
  - there is an accidental interference during play,
  - the shuttle gets caught in the net after passing over the net (except during service).

- the server serves before the receiver is ready.
- umpire is unable to make a decision.
- both sides commit a service court error.
- any other situation as deemed fit.
- A player will lose the rally if service is not correct or server misses the service or shuttle lands outside the prescribed area, shuttle passes through the net, shuttle does not cross the net, shuttle touches the walls/ceiling or shuttle hits twice on the player's racket and any part of her/his body touches the net.
- Three types of cards are used in Badminton, i.e. yellow card for first warning due to misconduct, red card for those who have been previously warned and black card for disqualifying a player for persistent misbehaviour, this shall render a player disqualified for the entire tournament.

### ACTIVITY 6.2

Is badminton played in your school? If yes, is it played in a specially prepared court? Observe the court and find out the measurements. Compare it with the Fig. 6.1 given in your book.

#### 6.2.4 Fundamental Skills of Badminton

##### *The Forehand Grip*

The grip is very important for a player. The racket is held with a shake hand grip. The 'v' between the thumb and fore fingers runs down the middle of the side of the handle as shown in Fig. 6.3.

##### *Backhand Grip*

In this, the player holds the racquet in the forehand grip. She/he then relaxes the grip and moves her/his hand over the top edge of the handle until the thumb lies flat along the back edge. The strength is directly behind the backhand face of the racket.

##### *Footwork*

Footwork is an essential skill for Badminton. Being agile and flexible, enables a badminton player move all over the court efficiently in accordance with a Forehand, Backhand, Drop, Drive shot etc. and these are given below:

##### *Strokes*

- **Forehand stroke** - The stroke which is hit from the right side of the body by the right handed player.
- **Backhand stroke** - The stroke which is hit from the left side of a right handed player.
- **Smash** - The player will jump upwards, sideways and backwards and the shuttle is hit (smashed) quickly and forcefully downwards.

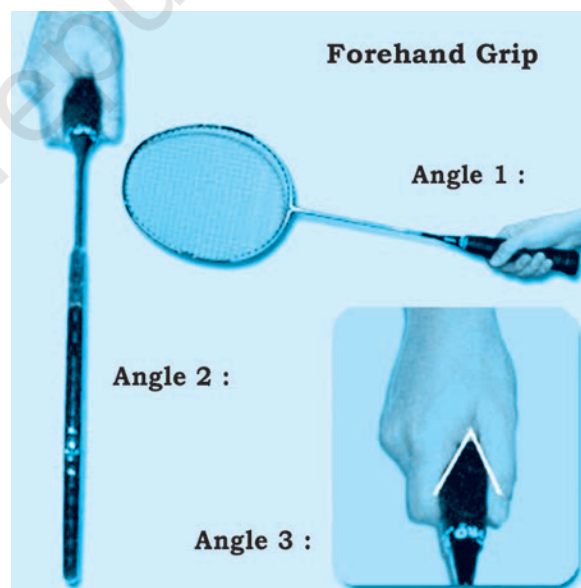

Fig. 6.3 : Forehand Grip

- **Drop** - This shot is slow and is hit gently but firmly and after clearing the net the shuttle falls close to the net.
- **Drives** - These are shots hit flat into the side zones with impact of the racquet hand.
- **Toss and clear** - The shuttle is hit high and deep towards the baseline of the opponent.

#### *The Service*

The service is one of the most important strokes. There are two basic badminton serves:

- Long/High service
- Short/Low service
- The player should be centrally located on the court standing halfway between the net and the backline and near the centre service line.

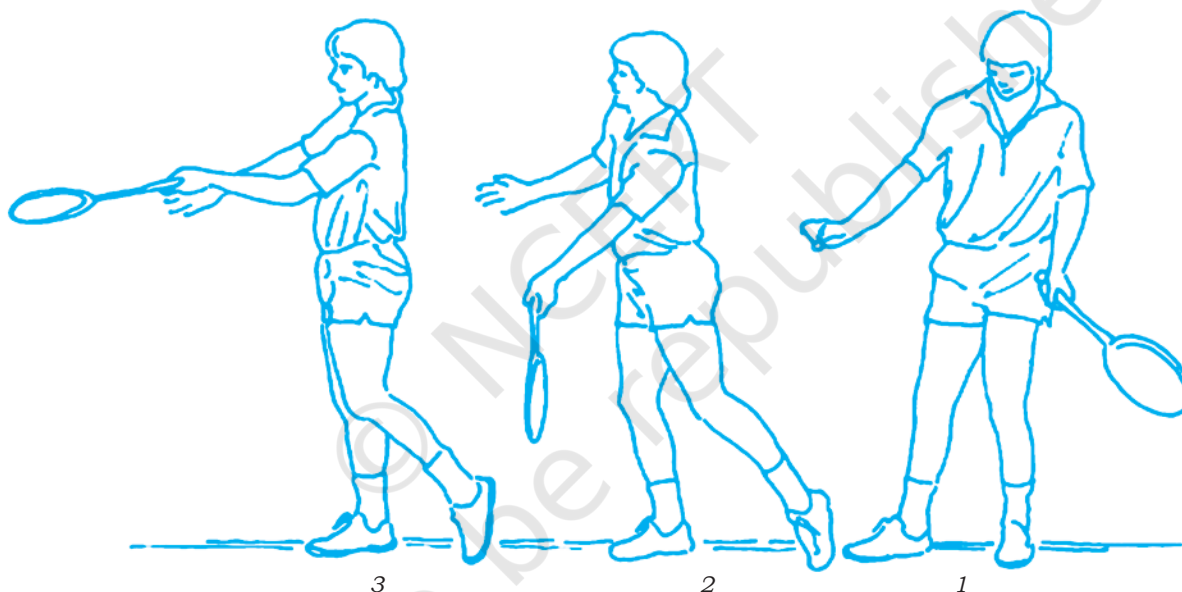

Fig. 6.4 : Badminton service

- keep the body sideways to the receiver's service court.
- using forehand grip the server takes the service position with both hands between the chest and shoulder.
- drop the shuttle and hitting hand is brought down and forward, forearm rotates upward at the point of contact.

#### **6.2.5 Scoring**

If a serve lands in the court of the opponent without volleyed back or the opponent returns a volley outside the play area, the server scores a point. In case of boys, it is best of five games of 21 points with two points lead, e.g. 21-19, 19-21, 22-20 and 21-17 and in case of girls, best of three games with same lead of two points.

### 6.3 GYMNASTICS

The word gymnastics has been derived from the Greek word 'Gymnos' meaning "naked art". In ancient Greek, the word "Gymnastics" was used to denote the exercise done with the naked body. Guts Muths, is known as the Grand Father of Modern Gymnastics and Friedrich Ludwig Jahn is known as the Father of Gymnastics. Modern gymnastics is regulated by the Federation International de Gymnastique (FIG) which was founded in 1881. Gymnastics was included in the Modern Olympic Games in 1896 and women gymnastics was introduced in Olympic Games in 1928. The first gymnastics world cup was organised in 1975. At present, gymnastics as an event can be seen in almost all the known multi sports meets.

#### 6.3.1 Types of Gymnastics

Broadly gymnastics has been classified in three types, i.e. Basic Gymnastics, Sportive Gymnastics, and Auxiliary Gymnastics.

Sportive gymnastics is further categorised as artistic (men and women), rhythmic, aerobics, acrobatics, and trampoline gymnastics. This chapter deals with artistic gymnastics which is a popular discipline of gymnastics. Artistic gymnastics apparatus for men are: floor exercise, pommel horse, roman rings, vaulting table, parallel bars, and horizontal bar. For women, the apparatus are: vaulting table, uneven bars, balancing beam and floor exercises.

#### 6.3.2 Basic Skills of Artistic Gymnastics

As you know now, gymnastics is performed on various apparatus and for all the apparatus some skills are identified as the basic skills of the game. Some basic skills, apparatus wise are listed below:

##### 1. Floor Exercises

Floor exercises are done on floor carpet. Measurement of floor mat is given in (Fig. 6.5)

- **Handstand** is an inverted gymnastics controlled skill performed by supporting the body on both hands, with the arms straight and the body vertical. (Fig. 6.5.1)
- **Cartwheel** is a common gymnastics skill where a gymnast starts with one leg push and

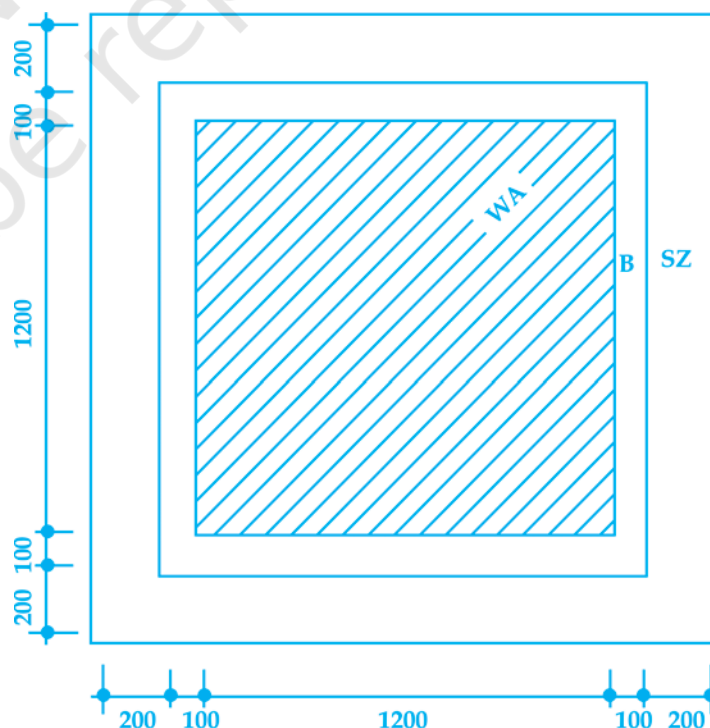

Fig. 6.5 : Floor Exercise Mat

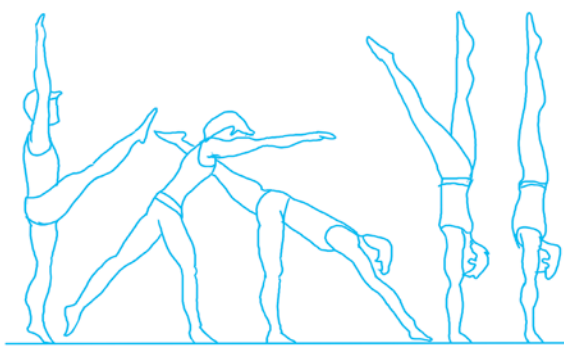

Fig. 6.5.1 : Handstand



Fig. 6.6 : Cartwheel

**ACTIVITY 6.3**

The student must learn to perform five floor exercises. As per availability of the apparatus.

places her/his hands on the ground in the same line while kicking with other leg up into a side handstand. The gymnast then lands with one leg on the other side followed by the other leg. (Fig. 6.6)

- **Front Handspring** is a forward tumbling skill that starts with a step or a hurdle. The body then bounces on to the hands and rotates through a handstand before landing on the feet. (Fig. 6.7)

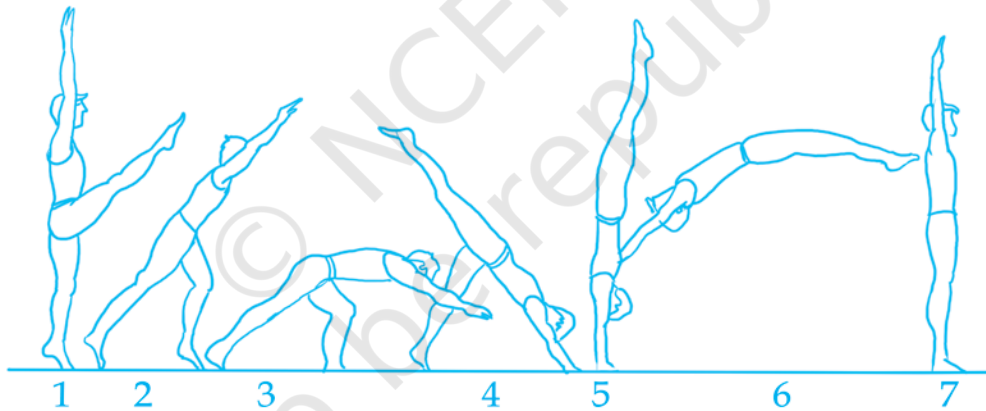

Fig. 6.7 : Front Handspring

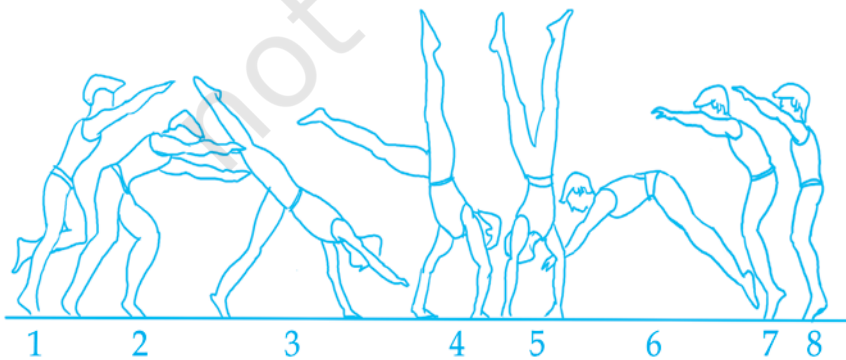

Fig. 6.7.1 : Round Off

- **Round-off** is a common gymnastics movement that leads into many more difficult skills. It is performed by pushing off one leg, swinging legs quickly in a cartwheel motion and landing on both feet with a half turn. It is usually the initial skill for all backward tumbling movements. (Fig. 6.7.1)



2. Pommel Horse (Fig. 6.8)

- **Leg swings** are considered as one of the basic swings on pommel horse. These are sideways swings which are performed with legs apart. Leg swings are the basis for scissors, leg cuts and undercuts and one leg circle. (Fig. 6.8.1)
- **One Leg Circle** can be done with right as well as left leg. The procedure and technique of leg circle is given in Fig. 6.8.2.

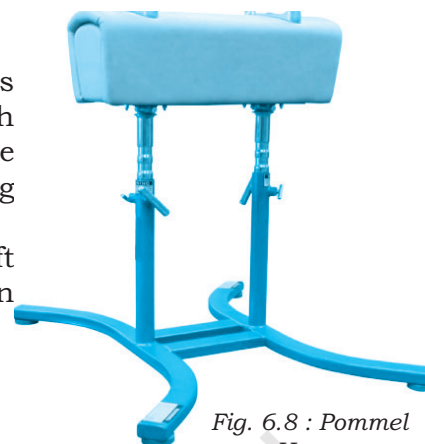

Fig. 6.8 : Pommel Horse

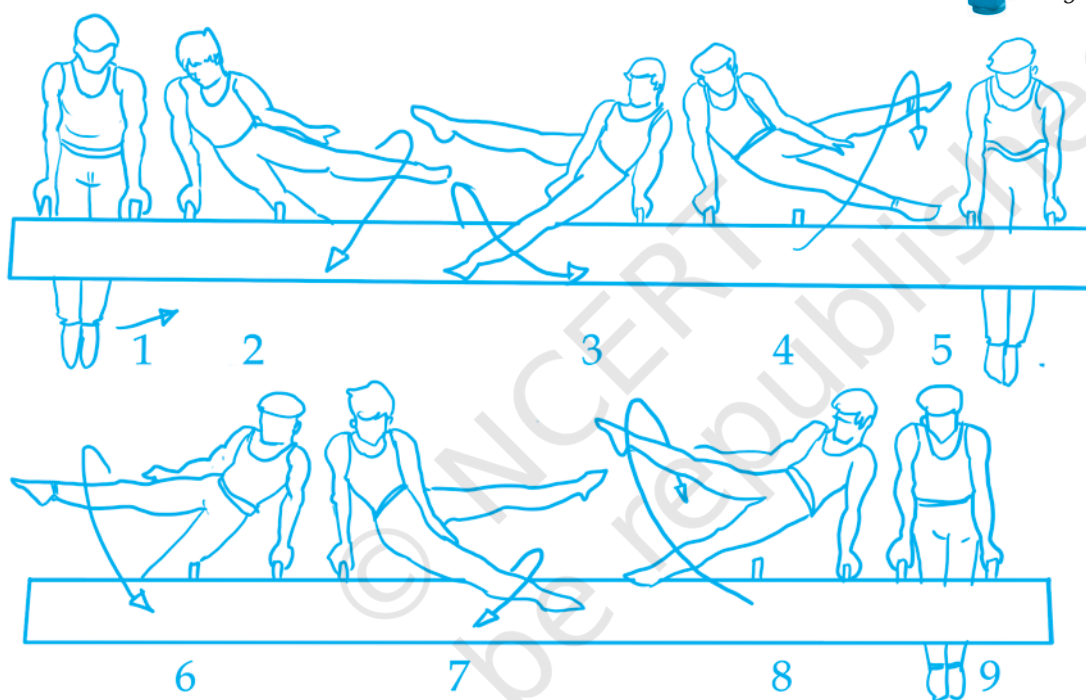

Fig. 6.8.1 : Leg Swings

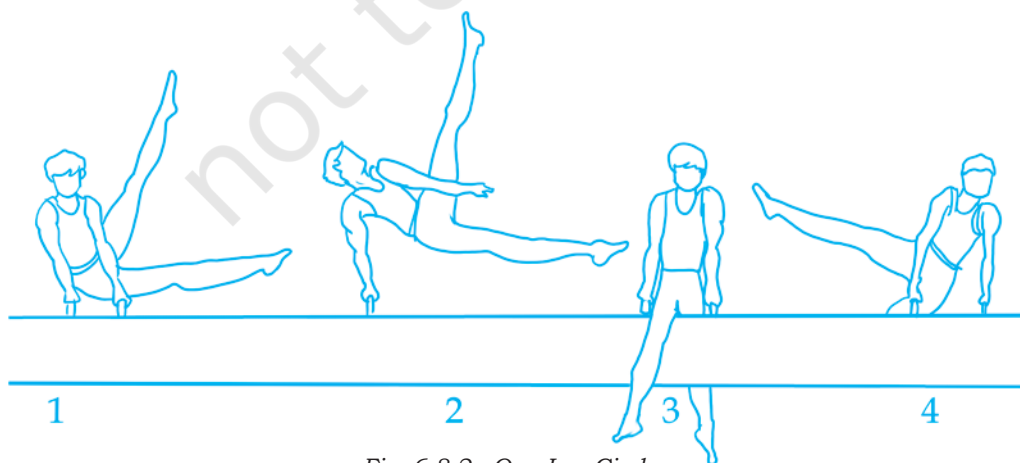

Fig. 6.8.2 : One Leg Circle

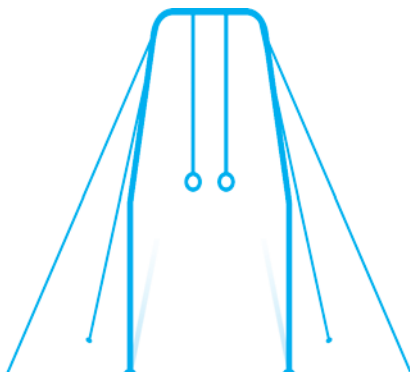

Fig. 6.9 : Roman Rings

### 3. Roman Rings (Fig. 6.9)

• **Inlocation** – This skill is typically performed by kicking heels high behind in a backward swing. On the top of the swing, head rolls forward and arms and shoulder rotate inwards, bringing the body once again into a pike position. (Fig. 6.9.1)

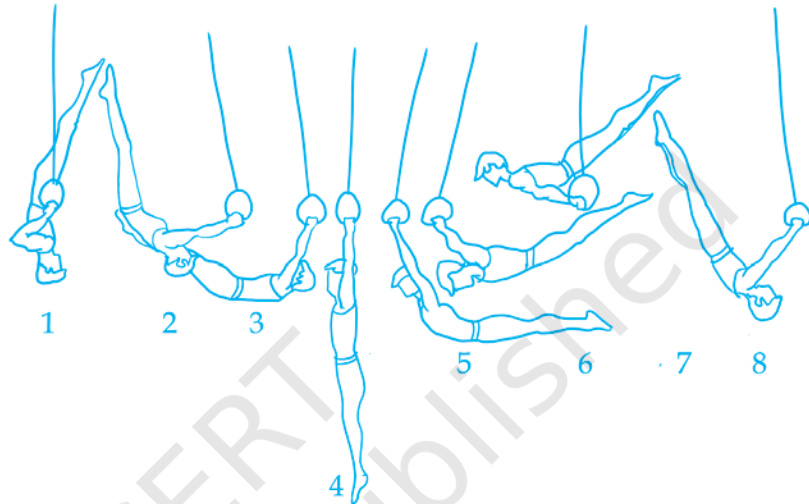

Fig. 6.9.1 : Inlocation

• **Dislocation** – This is a skill in gymnastics that involves a rotation of the shoulders when performing a forward swing or movement. Dislocation requires a good degree of shoulder flexibility. (Fig. 6.9.2)



Fig. 6.9.2 : Dislocation

## 4. Vaulting Table

- **Squat vault** – In this skill a gymnast crosses over the vaulting table with knees bent and body bent from the hips. (Fig. 6.10)
- **Split vault** – In this skill the body bends forward from the hips as the feet pass over the table with split (legs apart) legs. (Fig. 6.10.1)

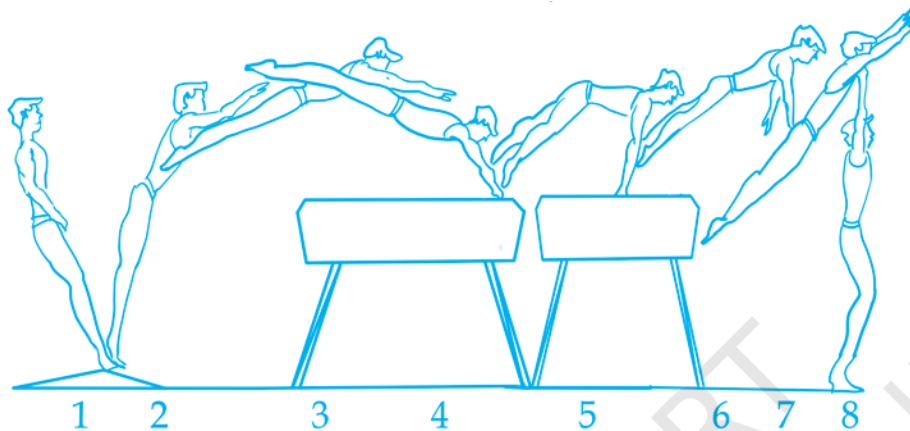

Fig. 6.10 : Squat vault

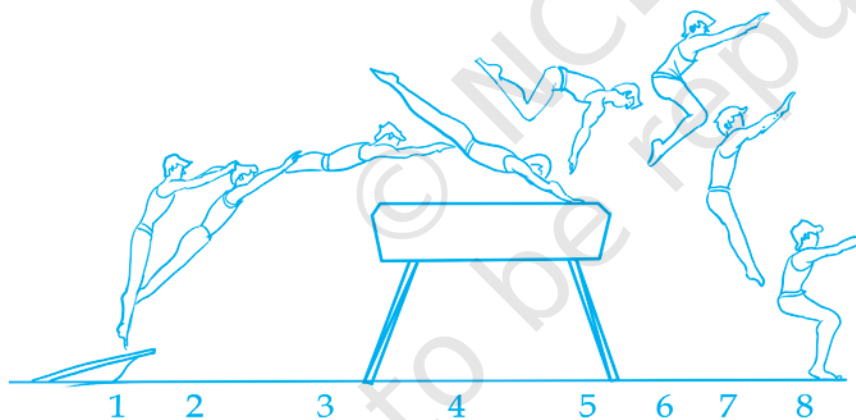

Fig. 6.10.1 : Split vault



Fig. 6.11 : Parallel Bar

## 5. Parallel Bars (Fig. 6.11)

- **Upper arm support swing** – At the start of front swing, the body is straight and slightly pike, with shoulders as high as possible. Thereafter, the body swings backward. (Fig. 6.11.1)

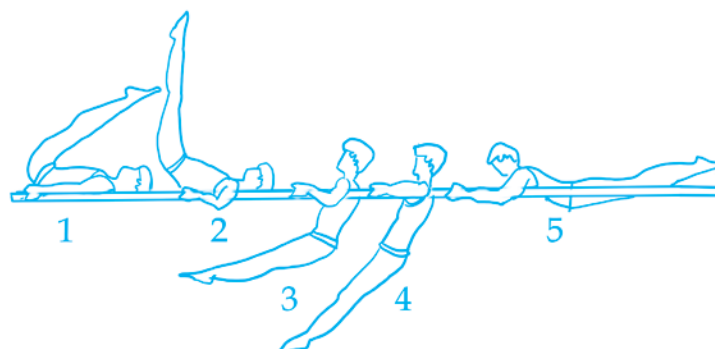

Fig. 6.11.1 : Upper arm support swing

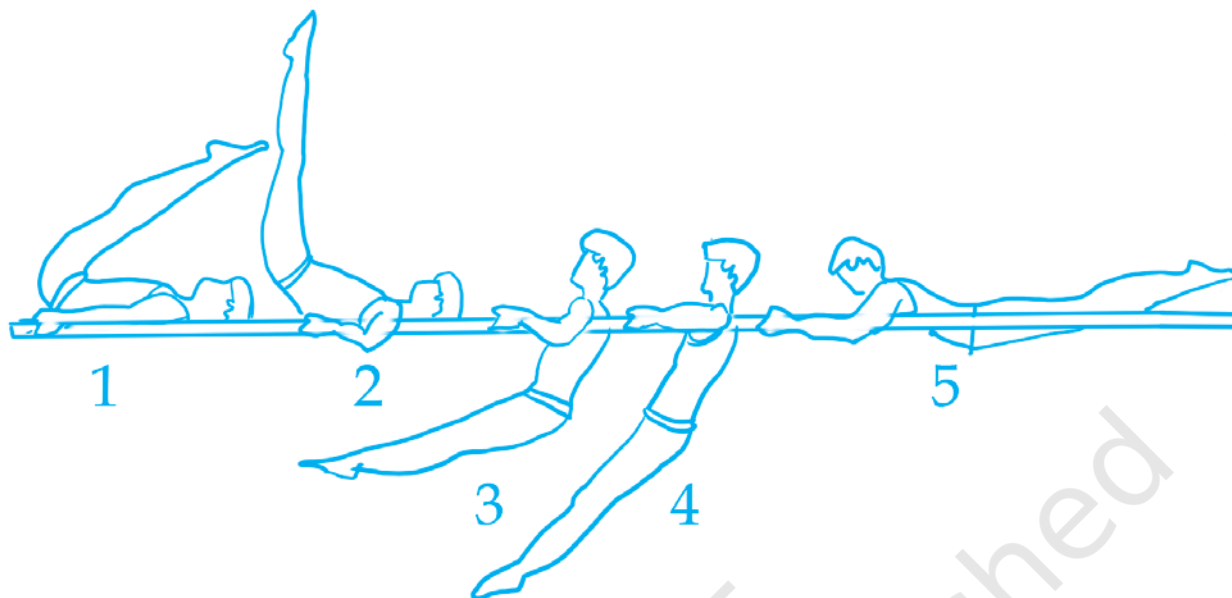

Fig. 6.11.2 : L-Hold position



Fig. 6.12 : Horizontal Bar

- **L-hold position** – In this position the gymnast's arms, legs and body are held straight over the parallel bars while legs are brought at an angle of 90 degrees at the hips in support position. (Fig. 6.11.2)

#### 6. Horizontal Bar (Fig. 6.12)

- **Front hip circle** – In this skill, the body acquires a forward movement around the bar while touching upper part of thigh to the bar and body rotates forward and downward around the bar in a circle.
- **Back hip circle** – In this skill, the body acquires a backward movement around the bar with the hips resting on the bar and the body rotating backward and downward around the bar in a circle.

#### 7. Balancing Beam (Fig. 6.13)



Fig. 6.13 : Balancing Beam

- **Balance on one leg ('T' Balance)** – In this skill a gymnast stands on one leg, with other leg backward above horizontal level keeping arms side ways and holds the position for 2 seconds.
- **Walking on the beam** - In this skill, the gymnast rocks the knees with feet pointing on each step and performs walk, with variations in arms movements. Eventually the arms position can be combined during the walk on each step changing from straight arms out to crown up and vice-versa.

## 8. Uneven Bars (Fig. 6.14)

- **Front hip circle** – The gymnast initiates the skill from support position. The gymnast falls forward with a tight body touching upper thigh or stomach, leaning well forward to initiate momentum and to complete the forward circle.
- **Back hip circle** – In this skill, from support position, a gymnast takes back swing, brings body forward and by touching the upper thigh with the bar takes shoulders backward and rotates around the bar.
- **Evaluation Procedure for the above elements (Movements)** – There are four elements on floor exercises and two elements each, on all other apparatuses given in this chapter. The evaluation of these elements will be done as per the following procedure.
  - (a) Value of each element is =5.00 points (each element will be evaluated out of 5.00 points)
  - (b) Value of four elements on floor exercises =20.00 points (Four elements  $\times$  5.00 points each =20.00)
  - (c) Value of two elements on pommel horse =10.00 (Two elements  $\times$  5.00 points each =10.00)
  - (d) Value of two elements on rings =10.00 points
  - (e) Value of two elements on vaulting table =10.00 points
  - (f) Value of two elements on parallel bars =10.00 points
  - (g) Value of two elements on horizontal bars =10.00 points
  - (h) Value of two elements on balancing beam =10.00 points
  - (i) Value of two elements on uneven bars =10.00 points



Fig. 6.14 : Uneven Bar

The total value for the boy's section comes to 70.00 points (i.e. 20.00 for floor and 50.00 for rest of the five apparatuses)

The total value for the girl's section comes to 50.00 points (i.e. 20.00 for floor and 30.00 for rest of the three apparatuses)

## 6.4 JUDO

Judo had its origin in the ancient Japanese art of Ju-jitsu (Gentle art), a system of hand-to-hand combat. It is a sport of Asian origin which was included in Tokyo Olympic Games in 1964. The first school of Judo was started by Professor Jigoro Kano in 1882 at Eishoji (a Buddhist temple) in Tokyo, Japan. As a player progresses through the ranks (Grading reflected by the belt of the Judo player) and the very nature of the grading system ensures that the next goal is always realistic and achievable with effort.

### ACTIVITY 6.4

Join a Judo class in your school or in your locality and share your experience with your friends.



### 6.4.1 Competition Area (Square)

The Judo platform is 18m long, 18m wide and 50cm in height.

Total area for competition : 14m x 14m

Contest area including danger zone : 10m x 10m

Danger zone in red colour : 1m in width

Safety area outside danger zone : 3m in width

Distance between the tapes

(red and white) at the centre area : 4m

Length of tapes : 25m

Width of tapes : 6cm

Duration of Bouts (boy/girl) : 5min/4min

The Judo bouts are played in different weight categories for equality and to avoid injuries because body weight has direct relation with body inertia, mass and strength (force) of an individual. There are following categories of Judo competitions in india:

1. Sub-junior girls having different weight categories.
2. Sub-junior boys having different weight categories.
3. Junior girls having different weight categories.
4. Junior boys having different weight categories.
5. Women (senior) having different weight categories.
6. Men (senior) having different weight categories.

**Note:** The weight categories keep on changing. For latest weight categories kindly contact the game website [www.onlinejbi.org.rulesdis.php](http://www.onlinejbi.org.rulesdis.php)

### 6.4.2 Judo Grades

Judo grades are divided into “*Kyu*” (pupil) “*Dan*” (master or teacher) grade.

- 10th *Kyu* will wear white belt
- 9th *Kyu* will wear yellow belt
- 7th and 8th *Kyu* will wear orange belt
- 5th and 6th *Kyu* will wear green belt
- 3rd and 4th *Kyu* will wear blue belt



Fig. 6.15 : Judo steps

- 1st and 2nd *Kyu* will wear brown belt
- 1st, 2nd, 3rd, 4th and 5th *Dans* will wear black belt
- 6th and 7th *Dans* will wear red and white striped belt
- 8th, 9th and 10th *Dans* will wear red belt.

### 6.4.3 Scoring

Scoring	Throwing	Holding
<b>Ippon</b>	Throwing the opponent with considerable speed, force and squarely on his/her back (control)	Maintaining a recognised hold for 20 seconds
<b>Waza-ari</b>	Throwing the opponent with speed and force and squarely to his back (control) but any one of the above component is lacking partly. (Note: two <i>waza-ari</i> become an <i>Ippon</i> )	Maintain a recognised hold for 15 seconds to less than 20 seconds
<b>Yuko</b>	Throwing the opponent with speed and force and squarely to his/her back (control) but any two of the above components is lacking partly.	Maintain a recognised hold for 10 seconds to less than 15 seconds.

**Special decision** – When not fit to continue because of injuries, winner is she/he, who is injured due to errors of his/her opponent and loser is she/he who is injured because of his/her own mistakes/faults.

### 6.4.4 End of Contest

The contest will end as under :

- scoring of *Ippon*.
- scoring of *Waza-Ari* Awasete *Ippon*.
- because of *Sogo-Gachi* (compound win).
- because of *Fusen-Gachi* (default).
- because of *Hansoku-Make* (disqualified).
- because of injury.
- because of expiry of allotted time.

### 6.4.5 Fundamental Skills

**Rei** (salutation) - *Rei* is of two types, i.e. **Ritsu-Rei** (standing salutation), **Za-Rei** (sitting salutation)

**Kumikata** (gripping) How to hold the judogi

- **Migi kumikata** (right side grip)
- **Hidari kumikata** (left side grip)

**Shintai** (walking movements)

- **Tsugi ashi** (following foot movements)
- **Ayumi ashi** (advance foot movements)

**Shizentai** (posture)

- **Shizen-hontai** (natural posture)
- **Shizen-jigotai** (defensive posture)

**Ukemi** (break fall or method or art of falling)

- **Ushiro ukemi** (back break fall)
- **Yoko ukemi** (side break fall)
- **Mae ukemi** (front break fall)
- **Mae mawari ukemi** (forward rolling break fall)

**Tai-sabaki** turning movements or management of body movements

**Kuzushi** breaking the balance of the defender (UKE) or off balancing the UKE for applying Judo technique.

**Tsukuri** Fitting the body of attacker (tori) against the UKE for applying a technique against UKE.

**Kake** Actual or final action of throw technique that is execution of the throw technique.

### ACTIVITY 6.5

You or your friend might have the experiences of swimming. Share your views about different strokes.

## 6.5 SWIMMING

Swimming is a sport where a person propels his/her body through the water with his/her arms, called strokes, and legs kick and move progressively through water. Swimming is sometimes used for physical rehabilitation of people recovering from injuries because it is a non-weight bearing exercise. It is also a good recreational activity.

Swimming was included in the first modern Olympic Games at Athens in 1896. The first Olympic Champion was Alfred Hajos from Hungary. Diving events were added in 1904. The women's competitions were recognised in 1912. Federation Internationale de Natations Aquatics (FINA) was formed at London Olympic Games in 1908.

### 6.5.1 Facilities and Equipment

- **Swimming Pool** : The standard dimensions of a swimming pool are: length 50m, width 25m and depth 1.80m.
- Eight lanes of 2.5 m width each (10 lanes for international competitions).
- The height of the starting platform shall range between 50-75 cm above the water surface; the top surface shall be 50 cm × 50 cm (Length × Breadth).
- Water temperature should be 24°C.
- Swimming costume is made of nylon or lycra. Other items needed are towel, swimming cap and swimming goggles.

### 6.5.2 Types of Strokes

There are four recognised strokes for a swimming competition :

- Front Stroke/ Free Style
- Back Stroke
- Breast Stroke and
- Butterfly Stroke

#### *Front Stroke or Free Style*

In freestyle events, a swimmer can swim in any manner. It is also called crawl because the swimmer uses alternate stroking of the arms over the water surface with up and down kick action of legs. In turning after finishing one length, some body part of the swimmer should touch the wall.

The swimmer lies flat on his/her stomach with both arms stretched out in front, passing by the side of ears and the water level is at hair line. Both legs are extended to the back with toes pointed. The arms are pulled alternately from front to back inside the water and recovered from outside the water. While one arm is pulling and pushing, the other arm is recovering.

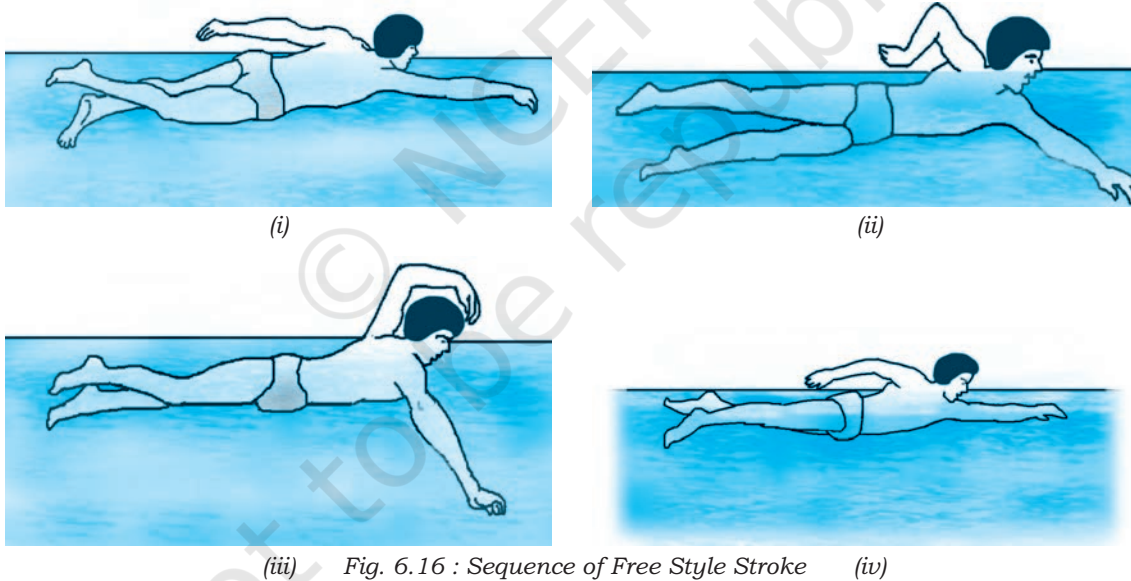

(iii) Fig. 6.16 : Sequence of Free Style Stroke (iv)

The legs move alternately up and down. While one leg kicks downward, the other leg recovers upward. The knees are flexed with toes pointed during the down beat and are kept straight with toes relaxed during the up beat.

The swimmer takes the breath through the mouth by turning the head to the side of the pushing arm at the beginning of recovery. Soon the face goes back into the water and the swimmer breathes out more through the mouth and only a small portion through the nose.

### Back Stroke

The back stroke consists of alternate action of arms with up and down kicking of legs while the swimmer is on the back. During a turn, the swimmer should bend from the stomach and take flip turn. Some body part of the swimmer should touch the wall and he/she should finish in the back position only.

The basic body position for the back stroke is the supine position. The swimmer lies flat on his/her back with both arms stretched out back over head, passing by the side of ears. Face is out of the water and both legs are extended forward with toes pointed. Hips are just below the water surface.

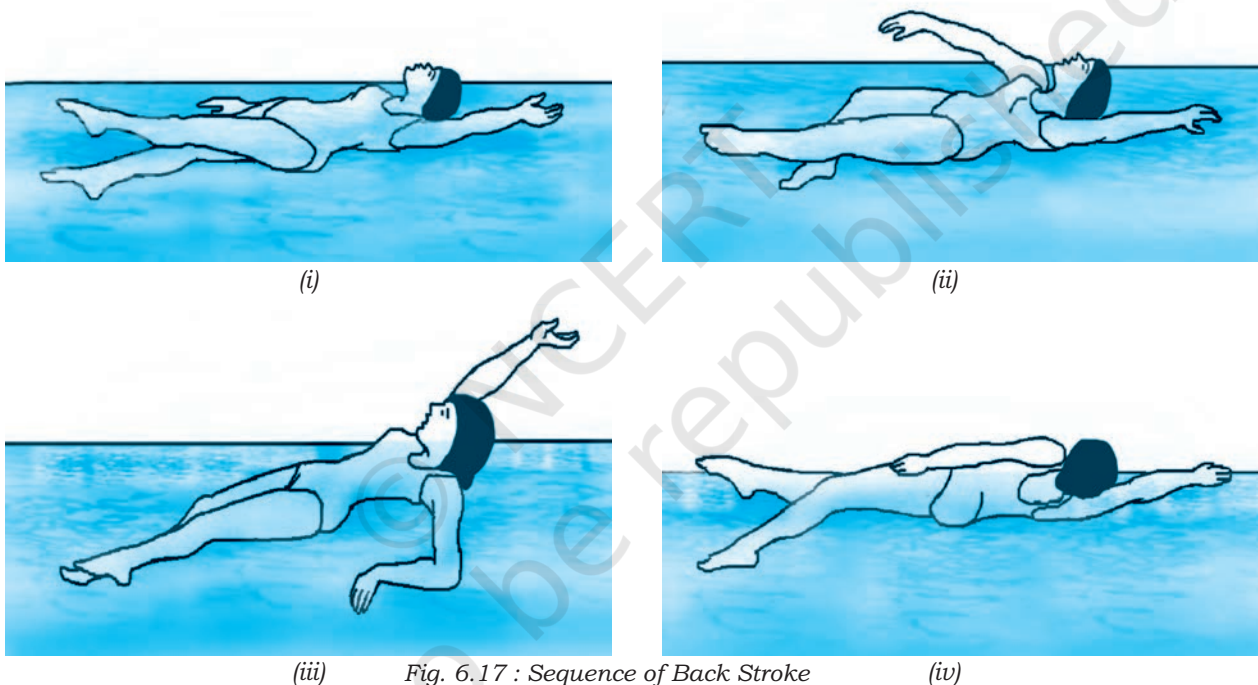

Fig. 6.17 : Sequence of Back Stroke

The arms are pulled alternately from back to front inside the water and recovered from outside the water with straight arm over the body. While one arm is pulling and pushing, the other arm is recovering.

The legs move alternately up and down. The leg movement originates from the hip joint. While one leg kicks downward, the other leg recovers upward. The knees are flexed with toes pointed during the up beat and are kept straight with toes relaxed during the down beat. Breathing in back stroke is very easy, as the mouth and nose are usually over the water. The swimmer breathes once in every arm cycle.



### Breast Stroke

The breast stroke involves simultaneous horizontal movements of the arms in heart shape to propel the body forward by pushing the water. The kicking action is in circular motion similar to that of frog. During turn and finish, swimmer must touch the wall with both hands.

Breast stroke involves lying on the chest, with the arms only breaking the surface of the water and legs always underwater, while the head is underwater for the second half of the stroke.

Both hands, thumbs together, reach forward, fully extending the arm at the elbow. The arms will stay in this position until the kick is completed by the feet. Arms continue to flex at the elbow. Leg kick starts to push back to continue the forward movement. The legs flex at the knee and hips to prepare for the kick. Breathing is usually done in the beginning of the in-sweep phase of the arms, and the swimmer breathes through the mouth.

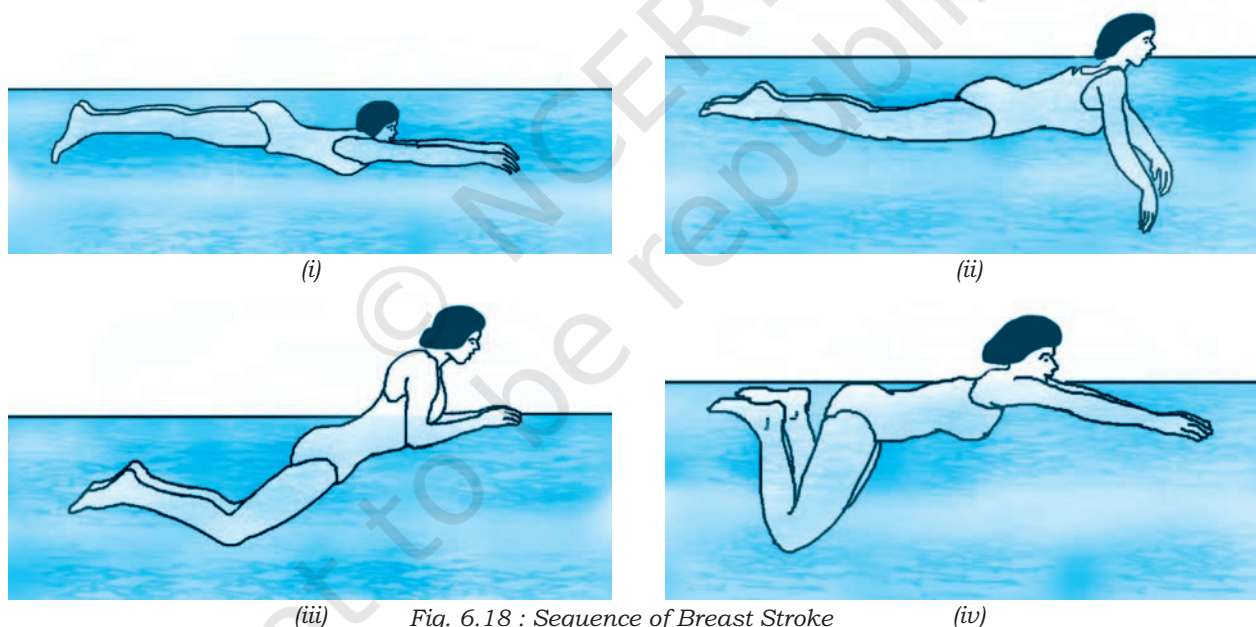

Fig. 6.18 : Sequence of Breast Stroke

### Butterfly Stroke

In this stroke, the swimmer must keep both the legs together and she/he should not use breast stroke. During a “turn” and “finish” both hands must touch the wall simultaneously.

The butterfly technique with the dolphin kick consists of arm movement with a leg kick. Both arms break the water simultaneously, hands and forearms first, the arms swing outwards, elbows slightly flexed as they both continue to

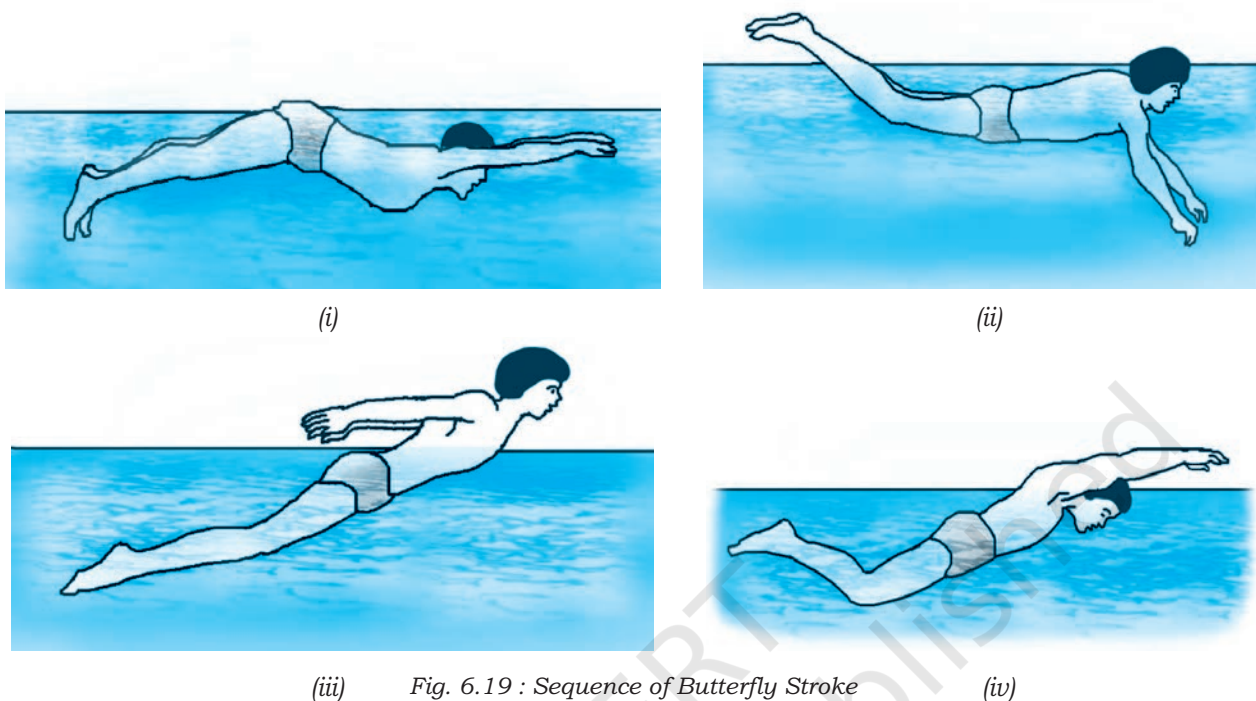

Fig. 6.19 : Sequence of Butterfly Stroke

swing, take a round and meet in front of the head, thumb and fingers entering the water first. As the hands come close to the body, they then press towards the feet, fully extending the arms at the elbow in preparation for the quick “flick” out of the water for recovery.

The shoulders are brought above the water surface by a strong up and medium down kick.

The breathing process begins when the swimmer presses both hands downward, and the swimmer breathes in through the mouth.

### 6.5.3 Before and after swimming the following care should be taken

- Take bath before and after swim.
- Wipe the body after shower with a clean towel.
- Swim under the presence of a lifeguard.
- Do not go into deep water if you are not confident.
- Warm up before swimming.
- Stretching and mobility exercises should be done before and after swimming.

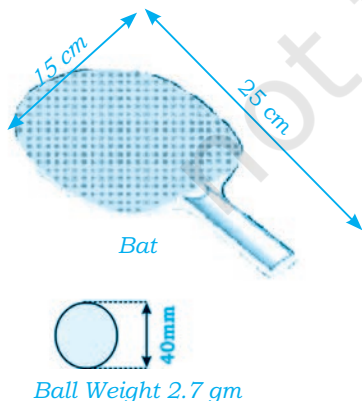

Fig. 6.20 Racket and Ball

## 6.6 TABLE TENNIS

International Table Tennis Federation (ITTF) was founded in 1926. Since 1988, Table Tennis has been an Olympic sport. Other historical names of table tennis were gossima, whiff-whaff and ping-pong.

### 6.6.1 Facilities

- The upper surface of the table, known as the playing surface is rectangular, with a dimension of 274 cm long and 152.5 cm wide. The height of the table is 76 cm above the floor.
- The playing surface shall be uniformly dark coloured and matt, but with a white border line, 2 cm (3/4inch.) wide, along each 2.74m (9 feet.) edge and a white end line as shown below in Fig. 6.21.

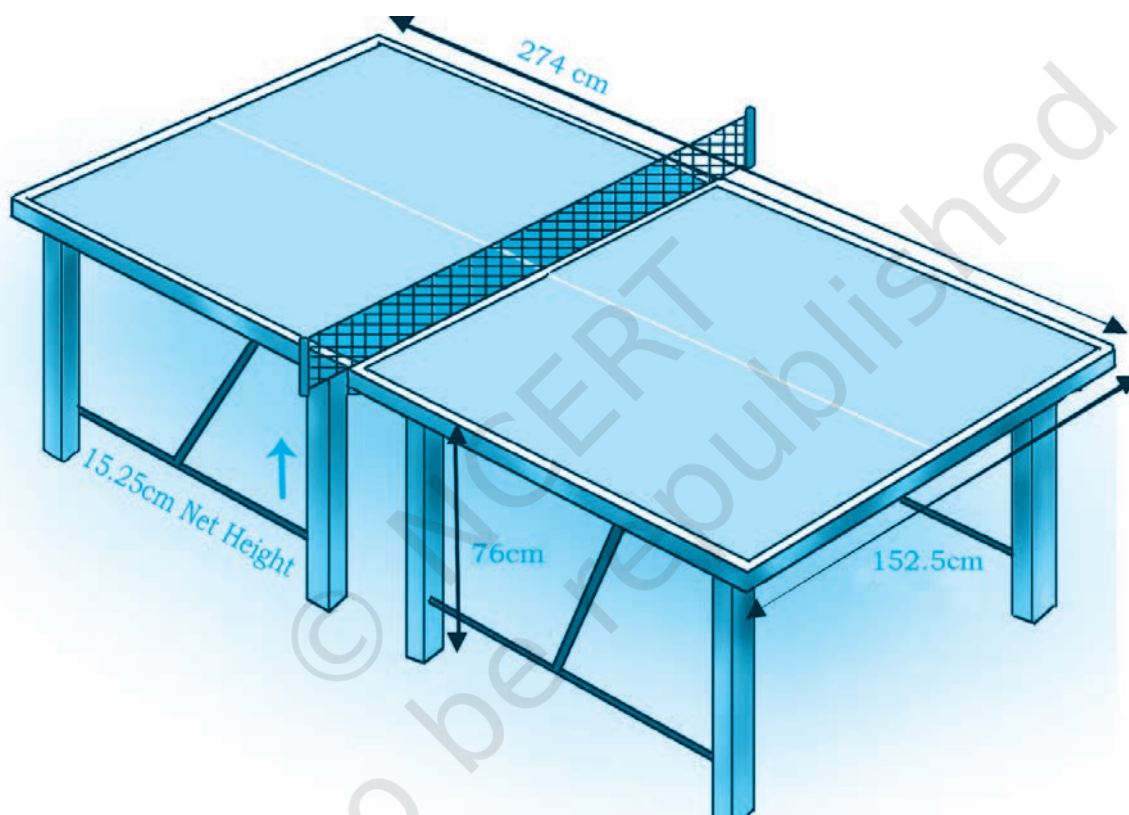

Fig. 6.21 : Dimensions of a Table Tennis Table

### 6.6.2 Equipment

- **Net Assembly** : which consists of upright post, height adjuster, horizontal part of the net post and attaching system (clamp). The net is suspended by a cord attached at each end to an upright post 15.25 cm high. The colour of net assembly should be of dark green, dark blue or black and have a white top not more than 15 mm wide.
- **Ball**: the ball is spherical, orange or white in colour made of celluloid or similar plastic material with a diameter of 40 mm, weight 2.7g. (Fig. 6.20)

### ACTIVITY 6.6

Find any three rules of ITTF related to the game of Table Tennis.

- *Bat*: The bat is also known as a paddle, or racket. The blade shall be flat and made up of wood of dark matte colour, one side black and other side bright red. But majority of rackets are of similar size about 15cm across and 25cm long including the handle. (see fig. 6.20)
- *Scoreboard*: The board, used for scoring is called Table Tennis Scoreboard.
- *Net Gauge* is used to measure the height of the net and also to measure the thickness of the racket and tension of the bat rubber which should be as per International Table Tennis Federation regulations.

### ACTIVITY 6.7

From the Table Tennis table available in your school, fill the given columns on the right side, and compare the standard norms given above.

	Dimensions		
	Table Tennis Table	Net	Ball
Shape			
Length			N.A.
Width			N.A.
Height			N.A.
Weight	N.A.	N.A.	
Diameter	N.A.	N.A.	

#### 6.6.3 Events

- Singles (Boys, Girls),
- Doubles (Boys, Girls),
- Mixed Doubles (Combination of boys and girls)

#### 6.6.4 How to play Table Tennis

- A player/team who wins the toss shall have a choice of service or receiving or side of the table to begin.
- The server shall project the ball resting freely on the palm, toss the ball and strike the ball with the bat. The ball must first touch down on the half of the table then it should pass over the net and land in the opponent's half without touching the net.
- The ball, having been served or returned, shall be struck so that it passes over the net assembly and touches the opponent's half of the table, either directly or after touching the net assembly.
- In singles, the server shall first make a service, the receiver shall then make a return. Thereafter, each server and receiver shall alternately make a return.
- In doubles, the server shall first make a service, the receiver shall then make a return. The partner of the server shall then make a return, and the partner of the receiver shall then make a return and thereafter each player in turn, in that sequence, shall make a return.



- The service shall be a “LET” if the ball touches the net and goes to the opponent half of the table or if a ball is served when receiver is not ready.
- If a player fails to serve or receive the ball, point shall be awarded accordingly.
- A game is won by the player who first scores 11 points. If both players score 10 points, then the player who get 2 point lead is declared the winner.

### 6.6.5 Basic skills of the Game

#### The Grip

There are two types of grips— the shake hand grip and the pen hold grip.

- Shake hand grip (fig 6.22) — The paddle (a part of the tennis bat) is held as if one is shaking someone’s hand, with the index finger extending over the bottom part of the rubber on the back hand side and the thumb slightly touching the rubber on the forehand.
- Pen hold grip (fig 6.23)— The paddle is held just like a pen, only grasping the paddle at the top of the handle.

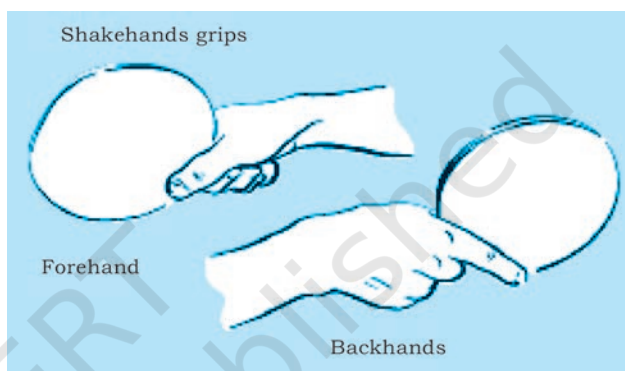

Fig. 6.22 : Shake hand grip

#### Spin

- There are three spins most commonly used — top spin, back spin and side spin. To hit a top spin the bat has to be angled in such a way so that the forehand - side faces downward 40 degrees (closed face).
- To hit a back spin, angle of the bat should be upward so that the forehand side faces the ceiling, facing upward 45 degrees (open face). Swing through the ball, but much speed should not be used as in topspin.
- A side spin is used in service. It is a combination of topspin and sidespin, or backspin and sidespin in the service.

#### Strokes

- Strokes are generally offensive and defensive: while performing a stroke the player should stand close to the table and take a stance facing the line of play. Now using a short stroke the racket arm should move from the elbow in a horizontal plane while the free arm should move upward. The strokes can be played with a backhand push and forehand push.



Fig. 6.23 : Pen Hold Grip



## 6.7 WRESTLING

There are two Olympic styles of wrestling, Freestyle and Greco-Roman. With one key exception, the rules of the two styles are identical.

In Greco-Roman, a wrestler may not attack his opponent's legs, nor use his own legs to trip, lift or execute other moves. In freestyle, both the arms and legs may be used to execute holds or to defend against attack. This style was introduced in 1904 at St. Louis Olympic Games. After a century, women free style wrestling was introduced in Athens Olympics in 2004.

In addition to the above one more style of wrestling is played in India which is called the Indian style of wrestling or otherwise known as *Pehlwani* or *Kushti*. This kind of wrestling takes place in a clay or a mud pit. Traditional Indian wrestling isn't just a sport, it's an ancient sub-culture where wrestlers live and train together.

### 6.7.1 Equipment and Facilities for indoor (Fig. 6.24)

- Wrestling is an indoor sport played on a mat.
- The wrestling area can be circle or square in shape (12 metre  $\times$  12 metre).
- The thickness of the mat should be between 5 to 7 centimetres.
- The mats are covered with a non-abrasive vinyl material which prevents slipping, injuries and is easy to clean.
- The bout is played on a yellow colour area with a diameter of seven metres.
- The centre circle in the middle of the playing area is of one metre diameter, generally of red and white colour.

### ACTIVITY 6.8

Visit an *Akhada* and write your observations.

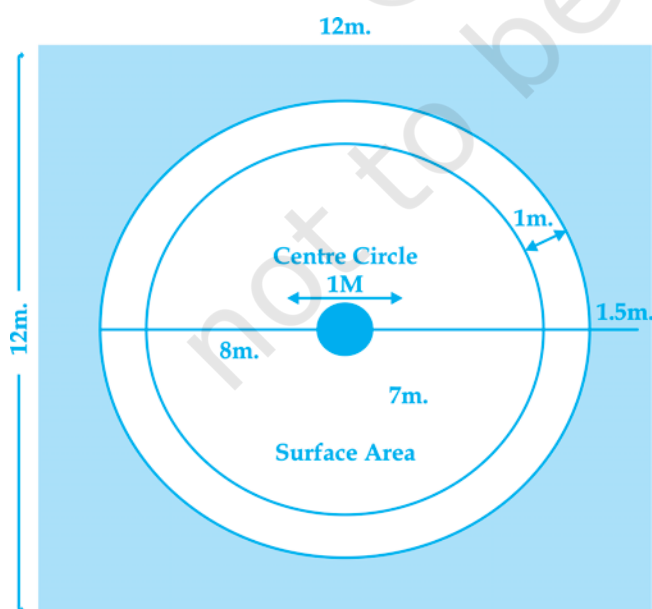

Fig. 6.24 : Wrestling Ring

### 6.7.2 How to Wrestle

- The sport of wrestling is played in different weight categories for both boys and girls. The weight categories are provided to minimise the chance of injuries and also to provide an equal platform for applying strength and force for all the wrestlers. The weight categories are different for junior level, senior level, open championships, world championships, Olympic championships and so on. The changes in weight categories are done by the Federations from time to time. As an example, weight categories for men and women are given below.

Gender	Age	Weight Categories (kg.)								
Men	29-32	35	38	42	47	53	59	66	73	85
Women	28-30	32	34	37	40	44	48	52	57	65

Note: International Wrestling Federation (FILA), rules July 2014, traditional wrestling Greco-Roman and Freestyle.

- A wrestler can participate in only one weight category in a wrestling competition.
- Wrestler(s) must appear on the mat wearing red or blue colour uniform as assigned to them. Both wrestlers shake hands in the centre of the mat and referee blows the whistle to start.
- There are three rounds of two minutes each. In case two rounds are in favour of any wrestler, she/he is declared the winner. Bout can also be won by fall.
- One point is earned when one wrestler takes the other to the mat and establishes control. However, if an attacking wrestler exposes the opponent's back to the mat in the process of the takedown, two more points are awarded. A maximum of five points can be awarded for throwing an opponent over one's head.
- If a wrestler is pushed out of bounds or attempts to escape a hold by stepping into the protection zone with at least one foot, the offensive wrestler is awarded a point.
- *Par terre* is when the action of the match is on the mat, with one wrestler in the top position and the other in the bottom position. The top wrestler is allowed to lock his hands anywhere on the body in order to turn his opponent to his back. Turning an opponent to the back, the attacking wrestler earns two points. If the wrestler holds the opponent on his back for five seconds or more, this will earn him an extra point.
- If there are no points scored in the *par terre* position by either wrestler after about ten seconds, the official stops the action on the ground and restarts the bout in the neutral position. This is done to keep the action going and allow both wrestlers more opportunities to score.
- If the score is tied at the end of a round, there is a specific tie-breaking criterion that must be followed to determine the winner. The criteria must be applied in the following order, moving on to the next rule when one rule does not apply:
  - The wrestler with the least amount of cautions or penalty points against him wins the bout.

### ACTIVITY 6.9

Prepare a scrap book on Indian famous personality of wrestling and discuss with your classmates.

### ACTIVITY 6.10

Identify famous Indian wrestlers. Take their photographs and make a collage.

- The wrestler who scored the highest number of technical points with one offensive manoeuvre wins the period.
- The wrestler that scores the last point before the end of the round wins.
- The clinch rule, or “ordered position,” is used to force action and decide the winner of a scoreless period. This position starts with one wrestler standing in the centre of the mat, and the other wrestler squatting and taking control of one of his/her opponent’s legs. The defensive wrestler (standing) is allowed to put his/her hands on his opponent’s back, but may not block or defend in any other way before wrestling starts. These offensive and defensive positions are chosen at random.
- Once the offensive wrestler has taken a leg, this is when wrestling starts. If the offensive wrestler scores in this position, wrestling is stopped and this wrestler wins the period. If the attacking wrestler does not score in this position at the end of this 30-second-period, the defending wrestler is awarded one point and wins that round of wrestling.



Fig. 6.25 : Square Stance

### 6.7.3 Skills

The seven basic skills are:

- stance
- motion
- level change
- penetration
- lifting
- back step
- back arch

#### Stance

While in the neutral (standing) position, some wrestlers prefer a square stance (Fig. 6.25) and others prefer a staggered stance (Fig 6.26). Either stance can work equally well. The wrestler should not stand straight up or leave herself/himself open to a takedown from the opponent. An effective stance always prepares the wrestler for a quick attack and proper defence.

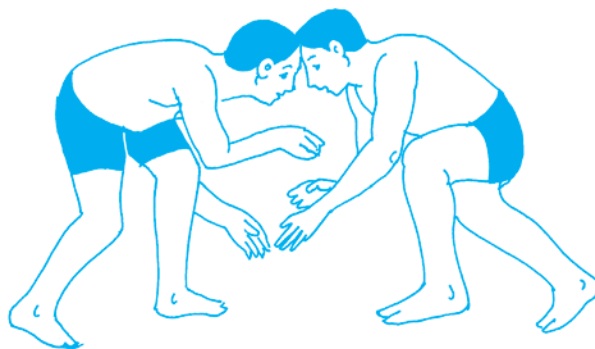

Fig. 6.26 : Wrestling Stance (Staggered)



Fig. 6.27 : Wrestling Motion

### Motion

Wrestling involves a tremendous amount of motion. Wrestler may circle their opponent. The wrestler may attack their opponent with a take down attempt. They may also snap the opponent to the mat and spin around behind him/her. The wrestler may also sprawl to defend against a take down and need to learn to move fluidly and quickly. All the movements need to be explosive and crisp.

### Level Change

Before a wrestler shoots a take down, he/she must lower his/her level. This is accomplished by lowering his/her hips. When a wrestler sprawls to counter a take down he/she is also using level change. In addition, a wrestler may lower and raise his/her level to force a reaction from his/her opponent. A wrestler needs to be able to maintain good posture while changing levels. For instance, a wrestler sometime over-extends when shooting a take down because he/she forgot to lower his/her level first. A wrestler should always bend at the knees, not at the waist.

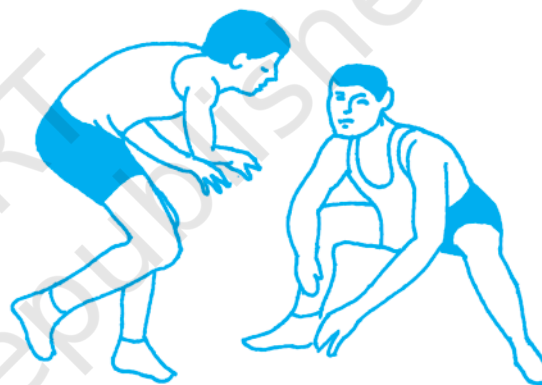

Fig. 6.28 : Wrestling Level Change

### Penetration

When a wrestler shoots for a take down on his/her opponent, he/she does not merely reach for the opponent's legs or dive wildly for the opponent's legs. He/she makes sure to be close enough to the opponent and then takes a deep penetration

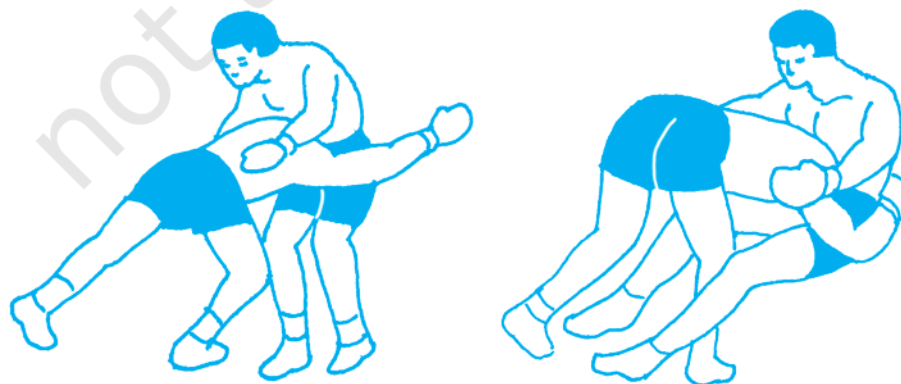

Fig. 6.29 : Wrestling Penetration

step, keeping the back straight and head up. Lower the level and penetrate deeply. Always make it sure to keep the hips forward and lower the shoulders, while driving through the opponent.

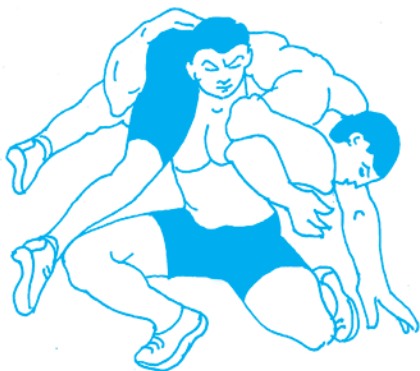

Fig. 6.30 : Wrestling Lifting

### *Lifting*

A wrestler often lifts his opponent off the mat when executing a take down as shown in fig. 6.30. He/she may also lift an opponent who has performed a stand up from the bottom position. The wrestler lifts his/her opponent and returns to the mat. The legs and the hips are most important when lifting. For instance, when a wrestler shoots a double leg, he/she does not lift with the back. He/she gets the hips squarely down and then uses the leg and hip strength to lift the opponent off the mat. When a wrestler has been lifted off the mat, he/she is in a very vulnerable position, lacking support and balance.

## ASSESSMENT

### Answer the following questions

1. Write down the history of badminton game.
2. Write any five rules of badminton game.
3. Write down the dimensions of the badminton court.
4. How do games and sports help to improve health fitness?
5. List down the Gymnastic events for men.
6. List down the Gymnastic events for women.
7. Which motor abilities can be developed through Gymnastics?
8. Write a short history of Judo.
9. Draw a diagram of Judo competition area with all specifications?
10. What is Judogi?
11. What is the name of the apex body which controls the Judo all over the world?
12. List down the names of swimming strokes.
13. Explain the technique of any stroke of your choice.
14. How does swimming help to improve the physical fitness of an individual?
15. Which motor abilities improve swimming performance?
16. Write any five important rules of the Table Tennis game.
17. How can playing Table Tennis help us in the improvement of our health?
18. Which fundamental skill did you enjoy the most in Table Tennis game and why?



19. Explain any one fundamental skill of Table Tennis.
20. Briefly describe the history of wrestling.
21. What is *Par terre*?
22. What is the duration of a wrestling bout?
23. What is the ordered position in wrestling?
24. Collect information about national and international Gymnasts with their photographs and write about them.
25. If you are a swimmer write down about how you enjoy it. If not, ask any of your friends who has a swimming experience of pond, river or pool about his/her experience.

### Fill in the blanks

- (i) Measurement of badminton court for singles is .....
- (ii) Measurement of badminton court for doubles is .....
- (iii) Height of the net from the floor is .....
- (iv) Rhythmic Gymnastics was included in Olympic games in ..... at.....
- (v) Measurement of floor for floor exercises in gymnastics is ..... metre.
- (vi) Judo was included in Olympic Games in.....
- (vii) The Judo platform is of 18 m × .....
- (viii) The meaning of *Ritsu Rei* .....
- (ix) The meaning of *Za Rei* .....
- (x) The meaning of *Migi Kumikata* .....
- (xi) The meaning of *Hidari Kumikata* .....
- (xii) The meaning of *Shintai* .....
- (xiii) The meaning of *Tsugiashi* .....
- (xiv) The meaning of *Ayumiashi* .....
- (xv) Standard swimming pool should be of .....m length and .....m width.
- (xvi) There are ..... lanes in standard swimming pool.
- (xvii) Width of a swimming lane is .....
- (xviii) Height of the starting platform of a swimming pool should be .....
- (xix) Temperature of water in a swimming pool should be ideally .....
- (xx) Measurement of a Table Tennis table is ..... length.....breadth.
- (xxi) Height of the Table Tennis table from floor is .....
- (xxii) Height of the net from surface of the table in TT is ....
- (xxiii) Length of the net TT is .....
- (xiv) Circumference of the TT ball is.....and weight is.....
- (xxv) Measurement of wrestling mat is .....
- (xxvi) The measurement of the mat area in wrestling is .....in length and .....in width.
- (xxvii) The diameter of the central circle in wrestling is .....
- (xxviii) The diameter of the yellow circle in a wrestling area... .

**Tick (✓) mark either Yes / No**

- (i) Four players are required to start a game in Badminton. (Yes/No)
- (ii) International Badminton Federation (IBF) was founded in 1934. (Yes/No)
- (iii) Player can leave the court in Badminton at any time. (Yes/No)
- (iv) Breadth of badminton net is 2'6". (Yes/No)
- (v) Height of the badminton net from floor is 5 feet. (Yes/No)
- (vi) Uneven bar is a men's event. (Yes/No)
- (vii) Balancing beam is a women's event. (Yes/No)
- (viii) Pommel horse is a men's event. (Yes/No)
- (ix) Parallel bars is a men's event. (Yes/No)
- (x) International Gymnastic Federation was founded in the year 1881. (Yes/No)
- (xi) The first school of Judo was started in 1882. (Yes/No)
- (xii) Judo was included in the Olympic Games in 1968. (Yes/No)
- (xiii) Professor Jigoro Kano started the first school of Judo. (Yes/No)
- (xiv) Judo is a sport of European origin. (Yes/No)
- (xv) *Shizentai* means posture. (Yes/No)
- (xvi) *Ukeme* means breakfall. (Yes/No)
- (xvii) *Ushiro* means back. (Yes/No)
- (xviii) *Mae* means front. (Yes/No)
- (xix) *Kake* means execution. (Yes/No)
- (xx) *Kuzushi* means breaking the balance. (Yes/No)
- (xxi) Can a swimmer change the lane after a start? (Yes/No)
- (xxii) There are four strokes in swimming. (Yes/No)
- (xxiii) A free style swimmer has to perform a similar type of movement. (Yes/No)
- (xxiv) A back stroke swimmer is not allowed to take rollover turn. (Yes/No)
- (xxv) Table Tennis game was invented in 1979. (Yes/No)
- (xxvi) Player in Table Tennis can be substituted at any time. (Yes/No)
- (xxvii) Player in Table Tennis can leave the game at any time. (Yes/No)
- (xxviii) Every player in Table Tennis has to change ends after each game. (Yes/No)
- (xxix) Wrestling is an outdoor sport, which is played on the ground. (Yes/No)
- (xxx) The wrestlers come to shake hands in the centre of the mat in red and blue colour. (Yes/No)
- (xxxi) The women free style wrestling was introduced in 2004 (Yes/No)
- (xxxii) Every bout contains 3 round of 2 minute each. (Yes/No)

# Team Games



13149CH07

## 7.1 INTRODUCTION

A team game is an activity in which players of the same team work together to achieve the goal. Team games help us to work together for winning vis-a-vis respect for each other. Team games are also good for new learners as these games can help in building self-esteem and team cohesion. For a good team in any game, the players have to stay together for progress and work together for success. Below are mentioned some of the team games.

## 7.2 BASKETBALL

You may have played basketball or have seen this game being played. Basketball is one of the world's most popular game. It is a fast, free-flowing, high-scoring team game. The players throw a ball in a basket horizontally positioned to score points while following a set of rules. Two teams play on a marked rectangular court with a basket at each end. The rules allow all players to move freely around the court and occupy any position on the court. All players get an equal opportunity to score basket. The way in which the game is re-started after a point is scored or a rule infringement makes it a fast game with few breaks in between regulation timing. To play this game, students should learn and practise the basic skills of ball dribbling, passing, receiving and shooting. Game of basketball involves neuromuscular coordination and often tall players are preferred.

### 7.2.1 History

The game of basketball was originated at the Springfield College of Physical Education Massachusetts, USA in 1891 by Dr James Naismith. In 1894 Naismith drew up the first 13 rules, which still form the basis of modern basketball rules. In India, the YMCA at Kolkata introduced basketball some 80 years ago. Later the YMCA established at Chennai in 1920 played an important role in the development of this game. Now-a-days basketball is one of the most favourite games in many schools and colleges. The game is played by both men and women of all ages and abilities. In order to promote the sport nationally and internationally and organise sports events related to basketball, Basketball Federation of India (BFI) was set up in

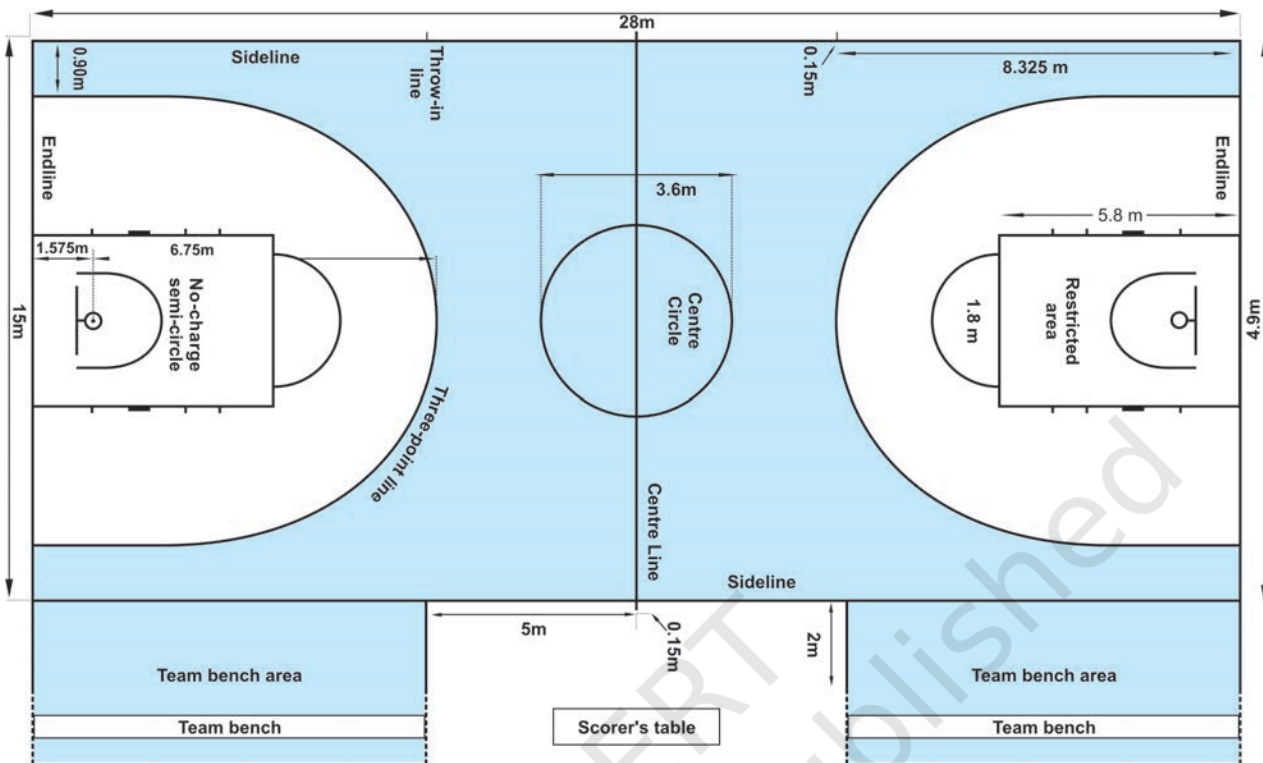

Source: Official Basketball rules 2012, as approved by FIBA Central Board, 29th April 2012, valid as of October 2012

Fig. 7.1 : Basketball Court

### ACTIVITY 7.1

Is it possible to play basket ball with different dimensions of court and with different ball size? Please write your comments. Also findout how playing any team game helps in improving physical and mental health?

1950. At the same time every state in India had formed a State Basketball Association. The first National Basketball event was held in Delhi in 1934, every two years till 1951 and there after it became an annual feature.

### 7.2.2 How to Play Basketball

- Basketball is played on a rectangular court, which could be an indoor wooden court or an outdoor concrete court. Basketball court dimensions are 28×15 metres. The court is divided into two sections, called half-courts, by the mid-court line, where the game starts with a jumpball. A jumpball is when a referee throws the ball up at centre circle to determine which team gets possession. Two players from opposing teams jump up to tip the ball, in the hope that one of them will secure the ball.
- The duration of the game of each quarter is ten minutes with 2 minute rest between first and second quarters and third and fourth quarters. Between second and third quarters the rest is 15 minutes. The duration of extra time is five minutes. Teams exchange courts in each quarter. The clock is stopped while the play is not active.

A team may consist of not more than twelve members, including a captain. But only five players from each team are on the court at one time. Substitutions are unlimited but can only be done when play is stopped.

The team with the ball, attempting to score is called 'on offense'. The team defending from scoring is called 'on defense'. The ball is moved in two ways: dribbling and passing to teammates. If the ball goes out of bounds, due to the offensive player/team, the possession is given back to the defensive team. This is a form of penalty, which results in the loss of a possession of ball.

Both men and women wear, a standard uniform consists of a pair of shorts and a jersey vest with a clearly visible number, printed on both the front and back. Players wear high top sneakers that provide extra ankle support.

The game is monitored by the officials consisting of the referee, one or two umpires and five table officials. The table officials are responsible for keeping track of each team scoring, timekeeping, and individual and team fouls, player substitutions, alternating possession arrow, and stop-and-go-clock.

**Equipments** – Essential equipments in a basketball game are: the ball, clocks, score sheets, scoreboard(s), alternating possession arrows, whistle and clock systems.

**Fouls** – An attempt to unfairly disadvantage an opponent through physical contact is illegal and is called a foul. Players who are fouled either get ball possession or are awarded one or more free throws, which is attempted from a line 15 feet (4.6 m) from the basket. Each player is allowed five fouls before they are rejected from the game and cannot come back.

### 7.2.3 Fundamental Skills

We are well aware that to play any game one has to learn some skills, To play basketball game one need to learn the following fundamental skills:

- **Player's stance** – Hold the ball with both hand fingers open, pointing forward, thumbs upward, feet apart and the knees slightly bent as shown in Fig 7.3



Fig.7.2 : Ring, Net and the ball



Fig.7.3 : Player Stance



- **Ball Handling Exercises** – Ball handling exercises are given below.
  - (i) Rotate the ball around the knees
  - (ii) Rotate the ball around waist.
  - (iii) Rotate the ball around neck.
  - (iv) Throw the ball front to back.



Fig. 7.4 : Two-hand Passing



Fig. 7.5 : Shooting

### ACTIVITY 7.2

Observe a basketball match and identify different forms of shooting.

### ACTIVITY 7.3

Set shot illustration is given in Fig.7.5 Collect photographs of other forms of shooting from various sources books, magazines etc. and discuss with your classmates.

- **Dribbling** – If you have seen any basketball game you might have observed that players bounce the ball between the dribbling hand and playing surface. This action of continuous bouncing is called dribbling. If dribbling is done on the spot, it is called stationary dribbling. You might have also noticed that players perform varied actions while dribbling. The variations are cross over dribbling that is changing of dribbling hand at the front side, reverse dribbling that is taking 180 degree turn from rear side and changing the direction, behind the back dribbling that is taking the ball from back side and bounce it on another side.

- **Passing and receiving** (Fig. 7.4) – While playing a basketball game, you need to transfer the ball from one player to another. Transfer of possession of the ball is called passing and a player who receives the ball is known as receiver. There are different types of passing namely—chest pass, overhead pass, bounce pass, baseball pass, hook pass and behind the back pass etc.

- **Shooting** (Fig. 7.5) – You might have observed that a player has to throw the ball into basket of the opponent team to win the game. Therefore, each team should make an attempt to score by throwing the ball in different forms of shooting such as two-hand set shot, one-hand set shot, lay up shot, jump shot and hook shot etc.

- **Rebounding** (Fig. 7.6) – Whenever a player makes an attempt to score the basket and if it is missed then the ball will rebound from over the ring or board.
- **Individual Defence** (Fig. 7.7) – While playing basketball if a team loses the possession of the ball, immediately player has to turn to individual defence. For a good defence, following factors are important (i) location of the player (ii) guarding distance (iii) movement (iv) vision and (v) footwork.

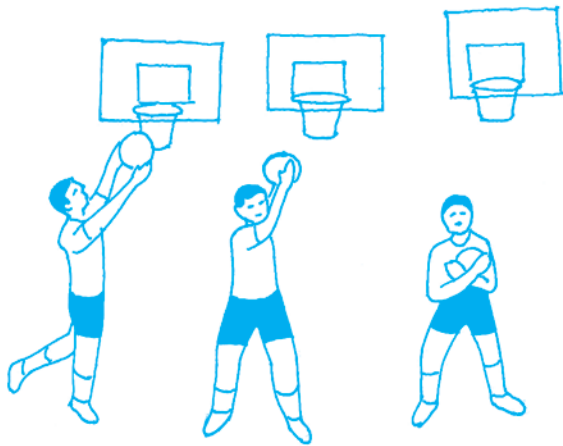

Fig. 7.6 : Rebounding



Fig. 7.7 : Individual Defence

### 7.3 CRICKET

You might have seen a cricket match being played in your school or on the television. Also you might have yourself played this game with your friends. This is a bat and ball game played between two teams on a field. In the centre of the field is a rectangular pitch. One team bats, trying to defend the wicket and scoring as many runs as possible. The other team bowls and fields, trying to dismiss the batsmen and thus limiting the runs scored by the batting team. Run can be scored by the striking batsman hitting the ball with the bat, running to the opposite end of the pitch and touching the crease there without being dismissed. The teams switch between batting and fielding at the end of an inning. In general this game is very popular.

#### 7.3.1 History

The origin of the game of Cricket was gradual. The Hambledon Club which was founded in about 1750 had played a significant part in the evolution of the game. It was superseded by the Marylebone Cricket Club (M.C.C) with its headquarters at Lords, London. Cricket became an international game with the formation of the Imperial Cricket Conference (I.C.C) in 1909. The name of Imperial Cricket Conference was changed to International Cricket Conference (later, Council) to enable countries outside the Commonwealth to become its members. Earlier only test matches were played where each team played two innings in five or lesser days. First One day International match was played in 1971 with limitations of overs per inning. The governing International Cricket Council (ICC) saw its potential and staged the first

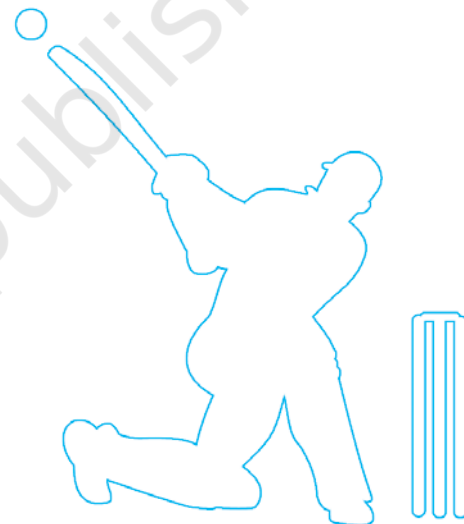

Fig. 7.8 : Cricket

**ACTIVITY 7.4**

- What is the full form of IPL?
- Write about your observation of any cricket match.
- Discuss with your friends, any cricket match you have seen.
- Write health related advantage of playing cricket.

**ACTIVITY 7.5**

How do you think that cricket can be played in other recreational form(s)? explain.



Fig. 7.9 : Out

limited over Cricket World Cup in 1975. In the 21st century, a new limited over form, Twenty20 and more recently IPL (Indian Premier League), has made an immediate impact.

Cricket was brought to India by the British. An England team toured India in 1902-03. An All-India team went on a tour of England in 1911 under Maharaja Bhupinder Singh of Patiala. The Indian Cricket Control Board came into being towards the end of 1928. India entered the international arena and played its first official Test against England in 1932. Meanwhile Prince Ranjit Singh of Nawanagar who had gone to England for further studies, made a remarkable name for himself in the game of cricket. He is generally acknowledged as the Father of Indian Cricket although he played only in England. He will always be remembered through the National Cricket Championship known as Ranji Trophy.

**7.3.2 How to play Cricket**

- A cricket match is played between two teams of eleven players each.
- The match is divided into periods called Innings. During an Inning, one team fields and the other bats. The two teams switch between fielding and batting after each Inning.
- All eleven members of the fielding team take the field, but only two members of the batting team are on the field at any given time. The fielding team's eleven members stand outside the pitch, spread out across the field.
- Behind each batsman is a target called a wicket. One designated member of the fielding team, called the bowler, is given a ball, and he attempts to deliver (bowl) the ball. If the bowler succeeds in hitting the wicket (Fig. 7.9), or if the ball, after being struck by the batsman, is caught by the fielding team before it touches the ground, the batsman is out.
- If the batsman is successful in striking the ball and the ball is not caught before it hits the ground, the two batsmen may then try to score runs for their team by running across the pitch. Each crossing and grounding by both batsmen is worth one run. The batsmen may attempt multiple runs or select not to run at all.
- If the batsman hits the bowled ball over the field boundary without the ball touching the field, the batting team scores six runs. If the ball touches the ground and then reaches the boundary, the batting team scores four runs.

- The inning is complete when 10 of the 11 members of the batting team have been dismissed, one always remaining “not out”, or when a set number of “overs” has been played.
- Field with positions in cricket are shown in Fig. 7.10

### 7.3.3 Field and Equipments

- The pitch is at the centre of the field. It is the area of the ground between the bowling creases one on both sides and it is 3.05m in width and 20.12m in length. The pitch shall not be changed during a match unless it becomes unfit for play.
- The ball will be leather skinned and its weight must not be less than 155.9 gms and not more than 163 gms. The circumference of the ball must be in between 22.4cm and 22.9 cm.
- A wooden bat should be 10.8 cm in width and 96.5 cm in length including the handle.

### ACTIVITY 7.6

Collect all the cricket standardised equipments and take them to the class. Have a discussion on measurement of different equipments and check whether these are of correct specifications.

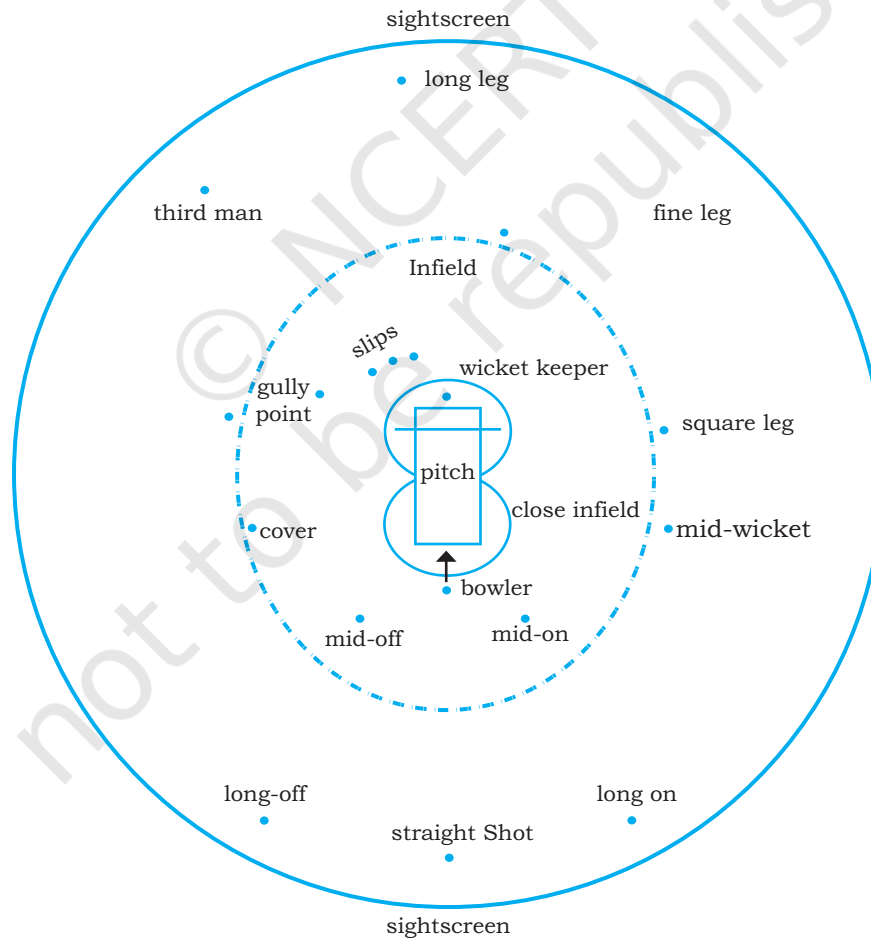

**source:** [www.dsr.wa.gov.au/assets/images/Diagrams/cricket-field](http://www.dsr.wa.gov.au/assets/images/Diagrams/cricket-field)  
Fig. 7.10 : Cricket Field

**ACTIVITY 7.7**

On a chart paper/blackboard draw the cricket field along with pitch. Show all the fielding positions and discuss with classmates.

- Each wicket is 22.80 cm in width and consists of three wooden stumps with two wooden bails on the top. The wickets should be pitched opposite and parallel to each other at a distance of 20.12 m between the centre of the two middle stumps. The stumps stand 70 cm tall and each bail is 11.1cm in length.
- The bowling crease is marked in line with the stumps at each end and is 2.64 m in length.
- The bowler bowls the ball in sets of six deliveries (or “balls”) and each set of six balls is called an “over”. When six balls have been bowled, another bowler is deployed at the other end, and the fielding side changes ends while the batsmen do not. A bowler cannot bowl two successive overs, although a bowler can bowl unchanged at the same end for several overs.

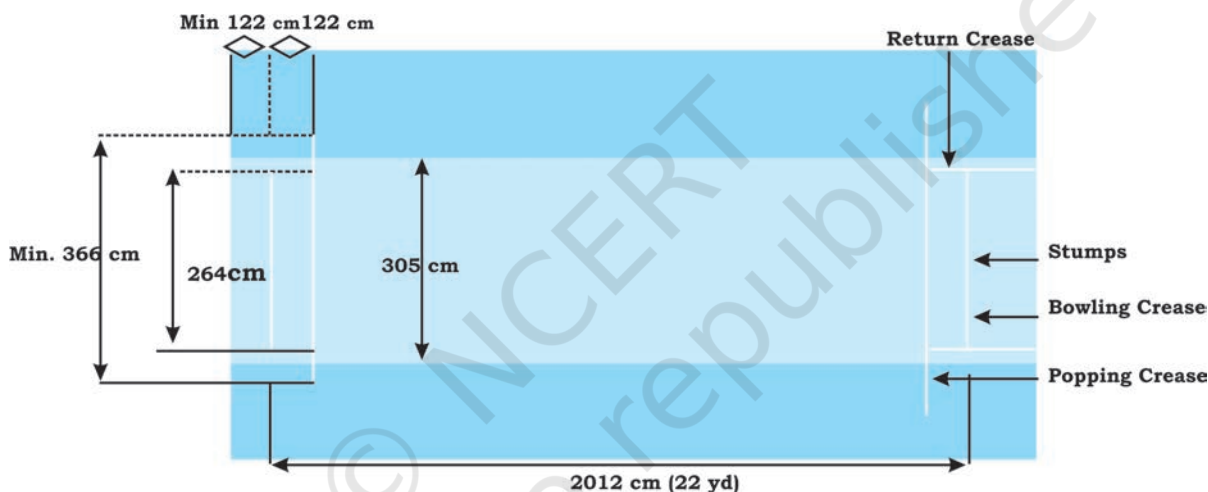

Fig. 7.11 : Cricket Pitch

- Two umpires are appointed one on each end (bowlers end and strikers end) to monitor the game. There is also a third umpire for play review. The umpire’s decision during a game is final in all matters.

**7.4 FOOTBALL**

With your friends you might have played football. Do you know the history of the game? Let us study some important information about football. Football was played in many countries in some form or the other. Federation Internationale de Football Association (FIFA), the world body to govern football was founded in Paris in 1904. In India, this game is governed by the All India Football Federation (AIFF). According to FIFA (Federation Internationale de Football Association), the very earliest form of the game for which there is scientific evidence was an exercise, a military manual dating back to the second



and third centuries BC in China. In India, football began its journey during the British rulers and in no time it became popular among the masses. The first recorded game took place between the 'Calcutta Club of Civilians' and the 'Gentlemen of Barrackpore' in 1854. The first football association, "The Indian Football Association" (IFA) was established in Kolkata in 1893. It was later on replaced by All India Football Federation (AIFF). The decade of 1951 to 1962 is known as the golden era in the history of Indian football, as the country put up commendable performances in a number of international competitions. India won gold medals in 1951 and 1962 Asian Games, held at New Delhi and Jakarta respectively. India became the first Asian nation to reach the Olympic football semi finals in the 1956 Melbourne Olympics. The AIFF had joined the Federation Internationale de Football Association (FIFA) in 1948.

#### 7.4.1 Field and Equipment

- The ball is made of leather, spherical in shape and the circumference of the ball is 68 to 70 cm whereas, the weight is 410 g to 450 g.

#### 7.4.2 How to play football

- The duration of the match of football is of 90 minutes divided into two equal halves of 45 minutes each with an interval of 10 – 15 minutes.
- In each team there are eleven players one of whom is the goalkeeper and six substitute players. To start a game, a team requires at least seven players.
- A coin is tossed and the team that wins the toss has the option to decide either of two goals they decide to attack in the first half of the game or to opt "KICK OFF" to start the match from center line. The option unchosen by the toss winner has to be opted by the toss loser. Team which has not started with kick off, starts in second half with changed ends with a kick off.
- A goal is scored when the ball fully crosses over the goal line. The ball has also to go between the goal posts and under the crossbar. Without any rule violation or break or without committing foul.
- Penalty of direct kick is given to the team for acts or attempt to act like kicks, trips and jumps during scoring.
- An indirect free kick is given to the opposing team in case a goalkeeper inside his/her own penalty area control the ball more than six seconds with his/her hands or touches the ball again with hands after release.
- For direct or indirect free kicks, the ball must be stationary when the kick is taken and the kicker does

#### ACTIVITY 7.8

Write any five rules of football games and discuss with your classmates.

#### ACTIVITY 7.9

Draw the sketch of the football field with all specifications on a chart paper / blackboard and discuss with your classmates.

not touch the ball a second time, until it has been played by another player.

- A penalty kick is given against a team that commits one of the ten offences. A goal may be scored directly from a penalty kick.
- A goal cannot be scored directly from a Throw-in. A throw is given when the ball passes over the touchline, either on the ground or in the air. The throw will be taken from the point where it has crossed the touchline, by the opponents who last touched the ball.
- A corner kick is awarded when the whole of the ball, passes over the goal line under the cross bar, either on the ground or in the air, having last touched a player of the defending team, and a goal is not scored in accordance with the relevant law.

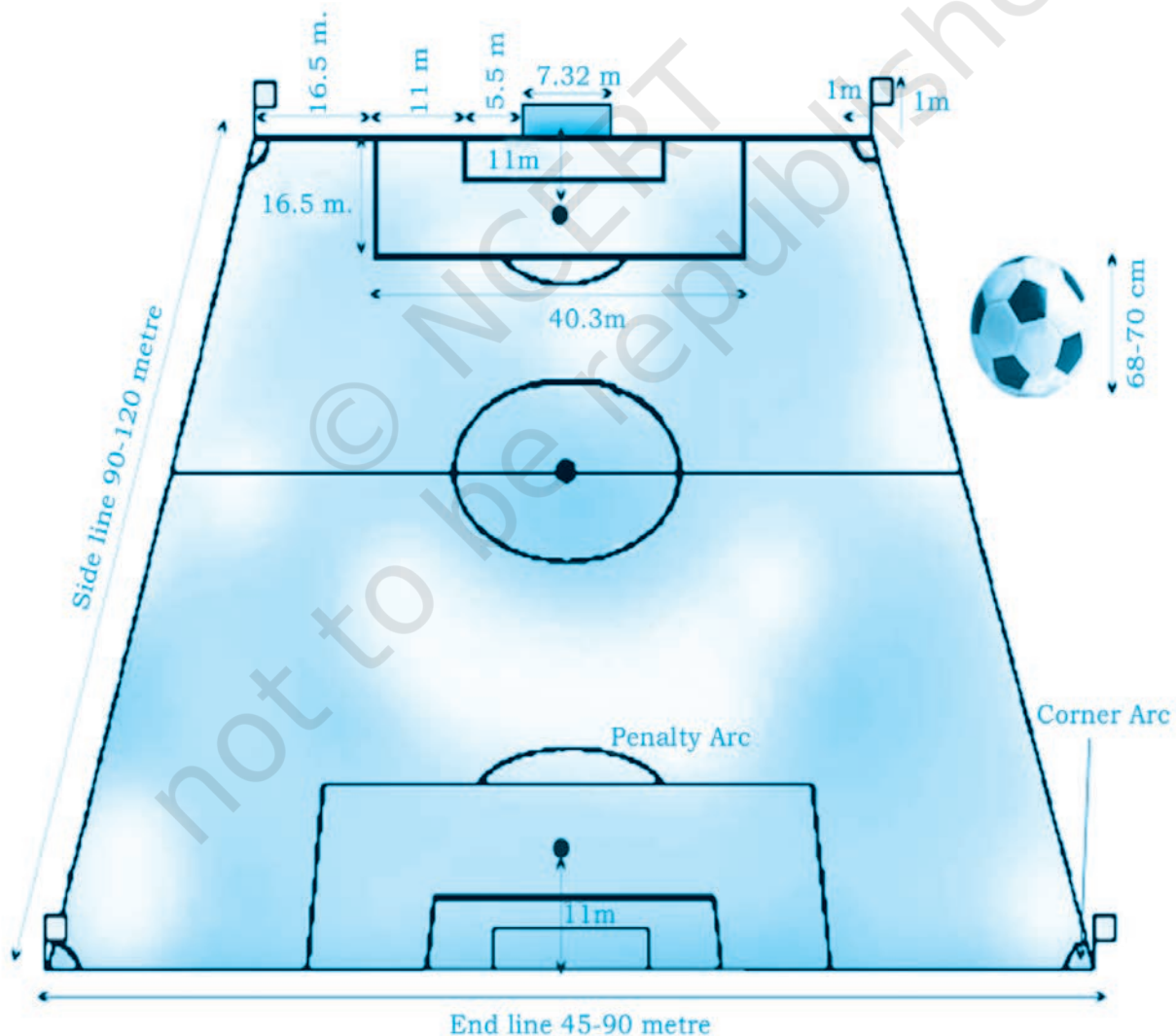

Fig. 7.12 : Dimensions of the football field

**Card system** – In football, there are two types of cards. *Yellow Card* which is used to communicate that a player, substitute, substituted player has been cautioned.

- *Red Card* is used to communicate that a player, substitute or substituted player has been sent off.



Fig. 7.13 : Dribbling

### 7.4.3 Fundamental Skills

- **Dribbling** (Fig. 7.13) – This is the most important skill in the game. The ball is dribbled on the ground with gentle strokes of the feet and moving in a specific direction with control. In dribbling, the player can use either the inside or the outside of the feet.
- **Heading** (Fig. 7.14) – Player should have made contact with the forehead in general otherwise any part of the head can be used. Sometimes the player may use the top of his head on a long pass or throw in. It is important for the player to keep eyes open and fixed on the ball and the body be positioned in line.
- **Kicking** (Fig. 7.15) – The ball is kicked by keeping the toe pointed out and ankle locked, strike the ball with laces part (in step) of the foot. Knees should be kept slightly bent and the ball should be kicked straight up into the air. The kicking leg should keep on swinging forward and upward direction in the direction of kicking.

### ACTIVITY 7.10

Practise dribbling heading, kicking, tackling and passing skills with your classmates.



Fig. 7.14 : Heading



Fig. 7.15 : Kicking



Fig. 7.16 : Tackling



Fig. 7.17 : Passing

- **Tackling** (Fig. 7.16) – This is gaining the ball possession or knocking it out from the opposing footballer
- **Passing** (Fig. 7.17) – The instep or the push pass is a common pass used in football. In this, the passing foot turns outward, locking the ankle, keeping the knee slightly flexed. It is a push type of action.

## 7.5 HOCKEY

You might have seen a Hockey match either in your school or on the television. Let us know more about this game by getting familiar with its history. Hockey as a game had been brought into India by the British servicemen and the first Hockey club was formed in Kolkata in 1885. The Hockey Association was founded in 1886. The first international tournament took place in 1895 and the International Rules Board was founded in 1900. The International Hockey Federation is the global governing body of field hockey founded on 7th January 1924 in Paris. India won all five Olympic Games from 1928 until 1956 and then again won in 1964 and 1980. In 1976 Montreal Olympics, artificial turf was used for the first time and that resulted in development of new tactics and techniques and also modification in rules.

### 7.5.1 Equipment and Facilities

- Hockey sticks are made of wood or composite material and it should pass through two inch ring. (Fig.7.18)
- The weight of the ball is between 156 gms to 163 gms with circumference of between 224 mm to 235 mm.(Fig.7.18)
- A goalkeeper must wear a helmet, leg guards and kickers. Usually she/he wears extensive additional protective equipment including chest guard, padded shorts, heavily padded hand protectors, groin protector, neck guard and arm guards.



Fig. 7.18 : Hockey stick and ball

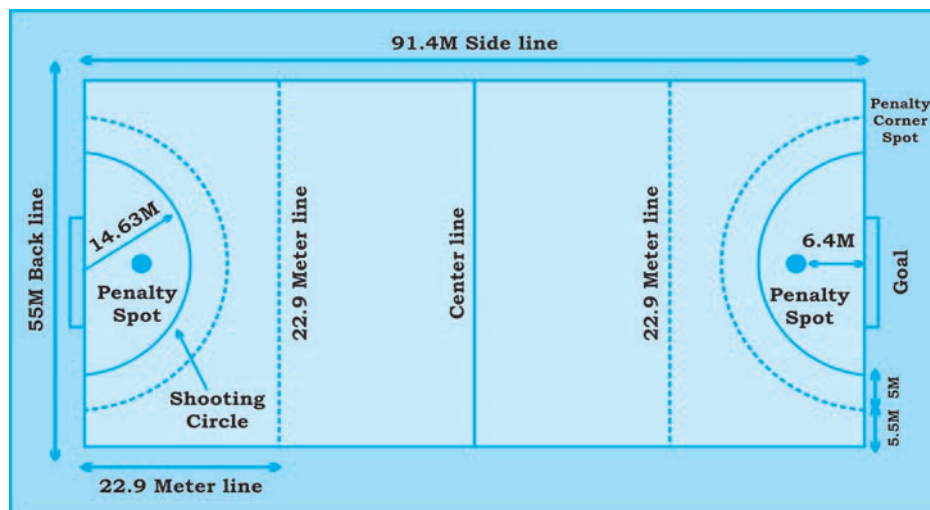

Fig. 7.19 : Hockey Field Dimensions

- The goal post is 2.14 m (7ft) in height and 3.66 m (12 ft) in width. Distance of shooting circle is 14.63 m from centre of goal line and dotted circle is 5 m away from shooting circle.
- The lines across the field are 22.9 m from each back-line and touching one side line to others.

### 7.5.2 How to Play Hockey

- A match is played between two teams of 11 players each, including a goalkeeper.
- The duration of the game is two halves, 35 minutes, each in collegiate and international play. The rest is of 10 minutes.
- The ball must be passed or dribbled down the field with the flat side of the stick.
- A goal is scored when an attacker strikes the ball into the goal from within the striking circle, even if the ball touches the defender and goes into the goal (Own Goal).
- If the score is tied after the stipulated time, extra time of two 7½-minute periods is played during which the golden goal rule applies. Even then if the score remains a tie then each team selects five players to decide the winner by tie breaker rule.
- A foul is called when any player shields, obstructs, plays the ball with rounded side of the stick, interferes in the game, charges, hits or trips an opponent, uses the foot or leg, raises the stick, stops the ball in the air, hits, etc.
- If a defensive player commits foul within the shooting circle, the attacking team is awarded a penalty corner.
- A penalty corner takes place, at least 10 m from the nearest goal post. The attacking player pushes or hits

### ACTIVITY 7.11

Draw a sketch of the Hockey field on the chart paper/ blackboard and through a discussion with your classmates indicate all the measurements.

### Box 7.1

#### Golden goal rule

When the goal is scored during extra time, the match stops and the team scoring goal is declared as the winner.



the ball to his/her teammate standing just outside the striking circle line. One player pushes the ball into the striking circle and the teammate hits into the goal post. During the hit only five defensive players will remain on self back line and rest of the players will remain on the centre line.

- A penalty stroke is awarded for any intentional violation by the defensive player in the circle for preventing a sure goal by foul means.
- During the penalty stroke, the goalkeeper must stand with both feet on the goal line and may not move either foot until the ball has been played. The offensive player may push, flick or scoop the ball from the penalty spot.
- When the attacking team plays the ball over the goal line, apart within goal post, the defense receives a 16-yard hit. The free hit is taken 16 yards from the spot where the ball crossed the backline.
- A push-in or hit-in is awarded to the opponents if a player hits the ball wholly over the sideline. All other opponents and their sticks must be at least 5 m away from the spot where the ball is put into play.

### 7.5.3 Fundamental Skills

- **Hitting** – The stick should be held with the left hand on the top and right hand should be just below it. Ball is positioned outside the right foot. The player strikes the ball with the centre of the stick by using swinging movement of the stick towards the ball.



Fig. 7.20 : Playing Hockey

- **Stopping** – The left hand should be kept on top of the handle of the hockey stick and the right hand near the middle of the stick. The body should face the direction of the ball, knees slightly bent and body also slightly bent forward.

When the ball is coming towards the player, the stick should be brought forward in line of the ball and gradually withdrawn and placed on the ground, slightly inclining it forward from top.

- **Dribbling** – A 'V' shape is formed by the index finger and thumb of the left hand which is placed on the inner edge of the top of the handle of the hockey stick and the right hand holds the stick loosely in the middle portion.

### ACTIVITY 7.12

- Hold the stick with both hands and keep it parallel to the ground. Tap the ball with stick for a minute.
- Stand in front of the wall and with a stick in hand and ball in front, push the ball to the wall and stop.
- Once you reach perfection in stopping and pushing, increase the distance between yourself and the ball and also between yourself and the wall.

The knees are flexed, upper body bending forward and feet shoulder width apart. The ball is placed in front of the right leg 8–12 inches away. The ball is tapped from the plain surface of the middle of the blade towards the left and then tapping the ball from the reverse stick in front of the left foot towards the right. This tapping movement continues from right to left and left to right.

- **The scoop** – This skill is also called the “aerial pass” or the “overhead pass”. The ball is raised in the air over the heads of the opponents.
- **The overhead flick** – The ball is kept in a stationary position and then raised over the heads of the opponents.
- **The push** – The grip is the same as for dribbling. A ‘V’ shape is formed by the index finger and the thumb of the right hand which shall be on the inner edge pointing downwards. The index finger of the right hand points downwards for better control.

A sideward stance is taken where the left shoulder faces the target and the ball is placed in front of the left foot in line with the right shoulder. Knees are slightly bent while executing this skill.

The stick is placed just behind the ball and it is pushed along the ground towards the target wherein the left hand is pushing the stick backwards and the right hand is pushing the stick forward.

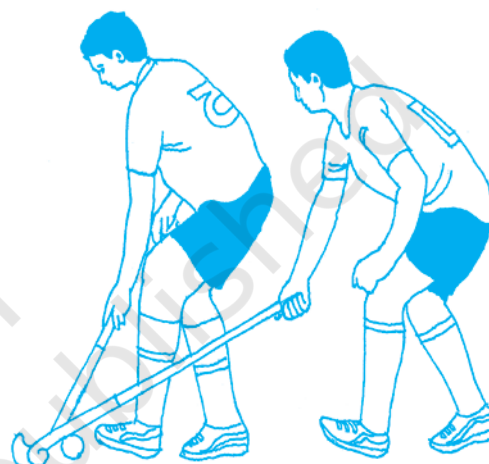

Fig. 7.21 : Players dribbling with ball



Fig. 7.22 : Player pushing the ball



Fig. 7.23 : Kabaddi Catch

## 7.6 KABADDI

You may be familiar with Kabaddi game. Kabaddi is one of the Indian games that demands agility, power and neuro muscular coordination. It also needs breath-holding capacity, quick response and a great deal of presence of mind. The game can be played on a plain and soft surface.

The first known framework of the rules of Kabaddi as an indigenous sport of India was prepared in Maharashtra in the year 1921. The modern Kabaddi game was played all over India and some parts of South Asia from 1930. The All India Kabaddi Federation was formed in the year 1950. The new body, Amateur Kabaddi Federation

of India (AKFI) came into existence from the year 1972.

The 1st Asian Kabaddi Championship was held in the year 1980 and was included as a demonstration game in the 9th Asian Games, New Delhi in the year 1982. The game was included in the South Asian Federation (SAF) games from the year 1984 at Dhaka, Bangladesh. Kabaddi was included as a discipline in the 11th Asian Games Beijing 1990 and India won the lone Gold Medal of Kabaddi in the 11th Asian Games Beijing 1990.

### ACTIVITY 7.13

Draw the sketch of the Kabaddi court with all specifications on a chart paper or blackboard and discuss with your class mates.

#### 7.6.1 Kabaddi Court

Length - 13 m.

Width - 10 m.

For playing Kabaddi, it is essential to have levelled ground with soft surface.

#### 7.6.2 How to Play Kabaddi

- There are two teams in Kabaddi. Each team consists of 12 players, out of which seven players play and remaining five are substitutes.
- A coin is tossed and the team that wins the toss shall have the choice of the court or the raid.
- The duration of the match has two halves of 20 minutes each, with an interval of five minutes.
- The player who enters the court of opposite team is known as raider and utters the word “Kabaddi” continuously and repeatedly in one breath.
- The raider has to repeat the word Kabaddi without break, clearly, aloud sounding within the course of one respiration, it is called ‘**Cant**’.
- A player/raider must begin **Cant** before he/she enters into the opponent’s court.

- If a raider touches an opponent player during cant or if any part of the body of an opponent touches the raider and raider touches his court with the cant, the opponent is said to be out.
- If opponent (s) hold the raider without breaking rules and do not allow him to reach her/his court until she/he loses the cant is known as holding the raider.
- If any player goes out of the boundary during the course of play, she/he shall be out and opponent will get one point.
- Once the raider reaches his/her court, opponent shall raid within five seconds.
- If one/two players are left in a team, the captain of the team may declare team out.
- Each team shall be allowed to take two “time outs” of 30 seconds in each half. However, during time out the teams shall not leave the ground.
- Players can be substituted with the permission of referee during time out or interval.
- Team which scores the highest number of points at the end of the match shall be declared the winners.
- If a raider does not touch the “bauck line”, he is declared out.

### 7.6.3 Fundamental Skills

#### *Raiding Skills*

The raider uses the following skills to make a successful raid.

- **Feint or fake** – A movement the raider uses to confuse the defender about his next move.
- **Leading leg raid** – The raider assumes a boxer’s shuffle stance throughout the raid.
- **Shuffling raid** – The raider shuffles his/her feet throughout the raid and suddenly changes the direction.
- **Reverse step raid** – The raider keeps changing his/her attacking front foot and back foot throughout the raid.
- **Hand touch** (Fig. 7.24) – The raider extends his/her arm towards the defenders and tries to create a struggling action to make one opponent out.
- **Hand swings** – These are used by the raider to touch his/her opponents or to touch one of the opponents.
- **Toe touch** – Here the raider extends his/her toes forward to touch the defender to touch out one of the opponents.
- **Foot touch** (Fig. 7.25)- In this skill, the raider tries to touch the defender with his/her foot to touch out one of the opponents.
- **Kicking** – The raider does a back kick, side kick or roll kick in order to touch the defenders.

#### ACTIVITY 7.14

Form two kabaddi teams from your class and play the game following the rules explained in the text.

Also prepare a Kabaddi Court in the field

#### ACTIVITY 7.15

Observe a Kabaddi match and identify the type of raiding skills and prepare a checklist. Finally, compare the same with your classmates.

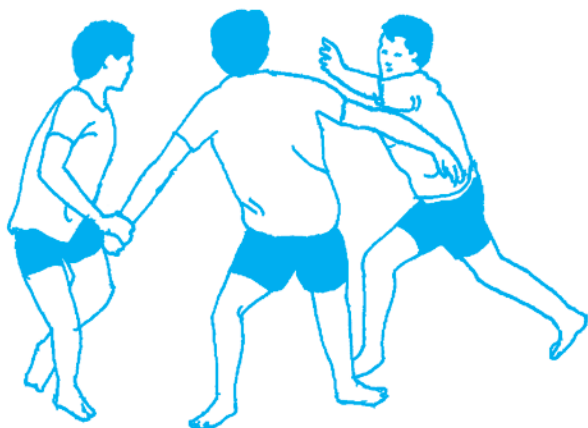

Fig. 7.24 : Hand Touch



Fig. 7.25 : Foot Touch

- **Safe raid** – Here the raider during a struggle can use the following tactics: jumping over a player, diving towards the centre line or rolling tactics.

#### Defensive skills

The antis use various techniques to save themselves and/or score point.

- (a) **Catch or hold** – while catching a defender should keep feet apart, knees bent and body weight on the toes. The different types of holds are wrist catch, ankle catch, dive and catch as well as trunk catch.
- (b) **Blocking** – Defenders block the path of the raider by creating wall of obstruction like full circle and half circle.

### 7.7 KHO-KHO

Kho-Kho is one of the popular indigenous games of India and is an inexpensive sport like kabaddi because it does not require much equipment. Many historians are of the view that the game of Kho-Kho is a modified version of 'Run and Chase'. In ancient era, a version of the Kho-Kho game was played on *raths* or chariots in Maharashtra. This was known as *Rathera*.

First sets of Kho-Kho rules were framed in the earlier part of 1900. A committee was constituted by the Gymkhana, Pune in 1914 for framing the Kho-Kho rules and the first Kho-Kho rule book was published in 1924 by Gymkhana, Baroda.

#### 7.7.1 Kho-Kho Play Field – Equipment and facilities

The playground of Kho-Kho is rectangular. The dimensions are as follows

- Length= 29 m
- Width = 16 m
- Free Zone 2.75 m
- First line from the post = 2.50 m



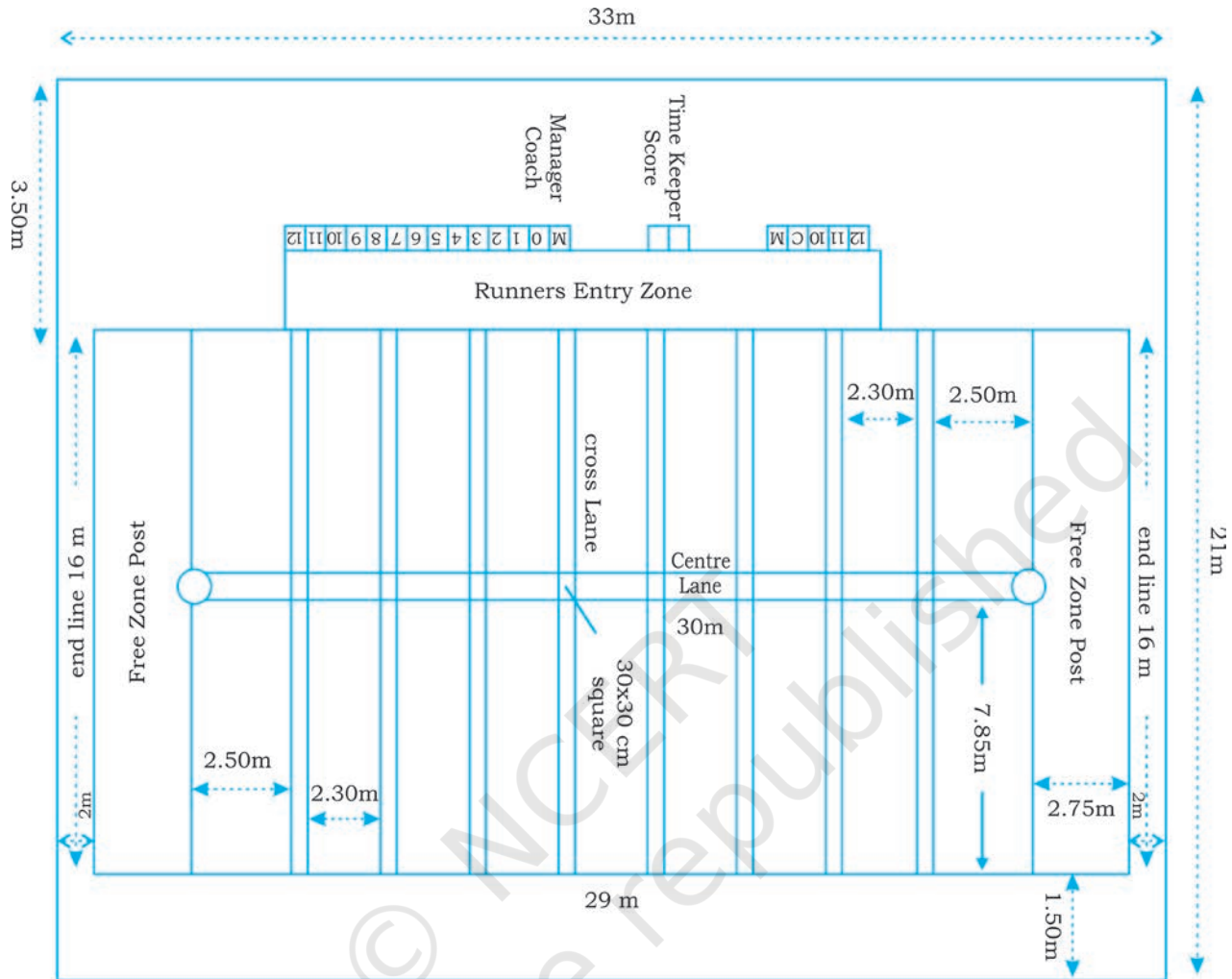

Fig. 7.26 Kho-Kho Play Field

- First square to second square = 2.30 m
- Height of the post = 120–125 cm

### 7.7.2 How to Play Kho-Kho

- There are two teams. Each team consists of 12 players, out of which nine players shall take the field in the beginning of the game.
- The team that wins the toss shall have the option of chasing or running.
- Any eight chasers shall occupy the squares facing the side lines in such a way that no two adjacent chasers face the same side line. The ninth chaser shall start the chase.
- The first batch of three runners shall be inside, in the play field and the remaining runners shall sit outside in the area marked for them.

### ACTIVITY 7.16

Keep all equipment together and make a Kho-Kho court in your school.

**ACTIVITY 7.17**

- Practise all fundamental skills.
- Play a match against other sections.

- After a runner is out, he/she shall sit outside in the marked area.
- Chaser shall not leave the square without getting kho.
- Attacker shall not cross the central lane if she/he does so, it will be a foul.
- Kho is to be given from behind a chaser.
- After giving a kho, a raider shall sit down immediately in the square of the sitting chaser.
- After getting a kho, the sitting chaser shall become an active chaser and move in the half that she/he was facing.
- A chaser shall move in the direction she/he turns the shoulder first. If she/he twists the shoulder more than a right angle in the opposite direction, it shall be a foul.



Fig. 7.27 : Kho pole tackle

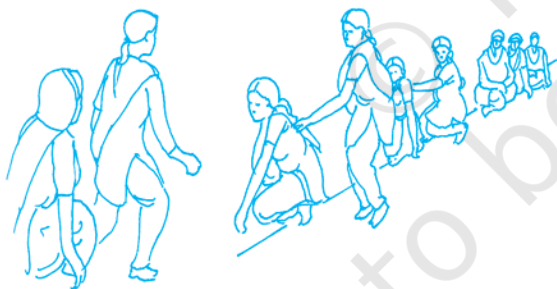

Fig. 7.28 : Kho giving



Fig. 7.29 : Kho chase

- During a turn, an attacker may go out of court but she/he shall observe all the rules about taking the direction.

- Match shall consist of two innings of 36 minutes, each innings has two turns of nine minutes with an interval of five minutes.

**7.7.3 Fundamental Skills**

These can be classified into two types — chasing and running skills.

**Chasing Skills**

- Giving Kho – a member of the team which is chasing gives kho by lightly touching his teammate on the back and says “Kho”. (Fig. 7.28)

- After receiving kho a chaser should take the first step in the direction in which she/he wants to go.

- The chaser after reaching the pole holds the post with one hand and with strongly holding the feet on the ground. She/he moves body forward as far as possible to touch a runner with the other hand. This skill is also called pole dive (See Fig. 7.29).

- When an active runner touches by extending an arm, it is called trapping.

- Chaser can bounce or dive to touch a runner if she/he feels that she/he can do so. A dive can be of the following types — sitting dive, turning dive, running dive, pole dive and side dive.

### *Techniques of Getting up*

- These techniques can be monkey crawl, standing or both.
- In monkey crawl, both hands should touch the ground without the body weight falling on them. Torso should be parallel to the ground. Eyes should watch the runner's feet but the head should not be lifted up. In this, the chaser can use any method to touch the runner.
- In the standing style, the chaser gets up slowly while turning the shoulder and then decides the direction to be taken to chase the runner.

### *Techniques of sitting in a square*

There are two techniques namely the toe method and the parallel toe method.

- In toe method, the players sit in the square keeping feet apart with one foot ahead of the other. The player shall sit with the support of the hands spread out.
- In parallel toe method, the chaser sits in the square and the feet are kept parallel to each other. Hands are placed outside the centre lane and fingers form a bridge. The knees are kept bent and parallel to each other.

### *Running Skills*

- The runners come in batches of three and take up scattered positions on the court.
- In chain, the runner runs in a zig-zag manner from one post to the other. When the player runs around two chasers in a zig-zag manner from one post to the other, it is called a double chain.

## **7.8 VOLLEYBALL**

Some of you are already enjoying playing Volleyball. Do you know how this game was originated, let us discuss.

Volleyball was invented by William G. Morgan in the year 1895. This game was invented as a recreational game. At first Volleyball was played without a net, throwing the ball from one group to the other. Then a net was used at a seven feet height. Thereafter Volleyball became one of the popular sports in the world. Volleyball can be played indoor or outdoor. Volleyball was introduced in 1964 Tokyo Olympics.

### **ACTIVITY 7.18**

Draw a Volleyball court on a chart paper or blackboard with all specifications and discuss with your classmates.

**ACTIVITY 7.19**

- Prepare Volleyball court and measure its dimensions correctly on field.
- Practise all fundamental skills.

**ACTIVITY 7.20**

Draw a diagram of volleyball court with all the measurements.

**7.8.1 Court Dimensions**

Court = 18 x 9m  
 Diagonal = 20.12m  
 Attack line = 3m from centre

**7.8.2 Equipments Required**

- An antenna is a flexible rod, 1.80 m long with a diameter of 10 mm, made of fibreglass or similar material.
- The posts supporting the net are placed at a distance of 0.50–1.00 m outside the sidelines. The posts mounted on the ground are 2.55 m high and preferably adjustable and rounded.
- **Ball** – The ball is spherical, made of flexible leather or synthetic leather case with a bladder inside made of rubber or a similar material. Its circumference is 65–67 cm and its weight is 260–280 grams.

**7.8.3 How to Play Volleyball**

There are two teams comprising 12 players each.

The referee does the toss to decide upon who chooses to serve first or select the side. If a deciding set is to be played, a new toss will be carried out. After the toss only six players from each team including the **Libero** start playing the game.

- Free Zone is five metres from the side lines and eight metres from the end lines.
- All lines are five cm wide, light in colour and different from the colour of the floor.
- Attack line is three metres away from the centre line, marks the front zone. Attack line is extended by the addition of broken lines from sidelines.
- Front Zone is limited by the axis of the centre line and the rear edge of the attack line. The front zone is considered to extend beyond the sidelines to the end of the free zone.
- Service zone is a nine metre wide area behind each end line. It is laterally limited by two short lines, each 15 cm long, drawn 20 cm behind the end line as an extension of the sidelines.
- Net top is set at the height of 2.43 m for men and 2.24 m for women. Height is measured at the centre of the court.
- **To Score a Point, To Win a Set and the Match Point** – A team scores a point by successfully grounding the ball on the opponent's court.
- **Fault** – A team also scores a point if their opponent touches the ball more than three times or any opponent touches the ball twice continuously. Block will not be counted as a touch. A point will also be awarded if fault is committed.

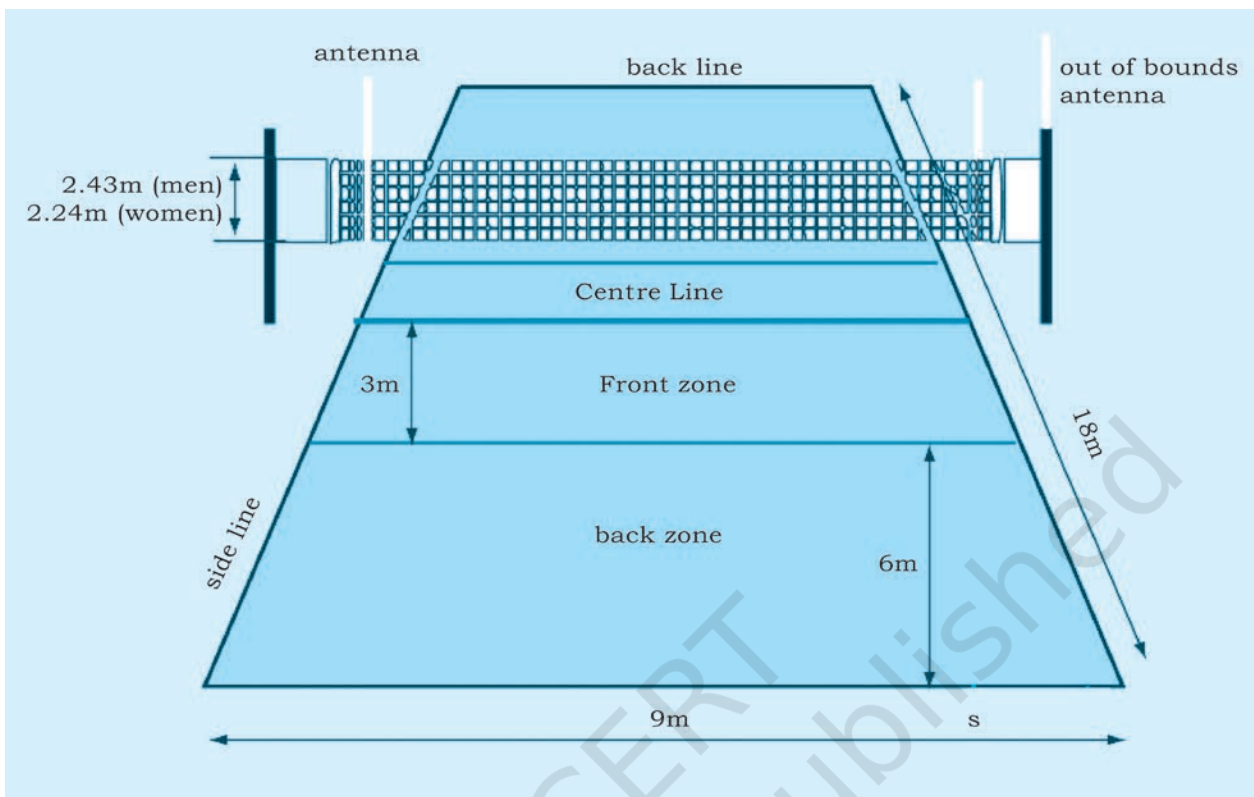

Fig. 7.30 : Volleyball Court

- **Consequences of winning a rally** – A rally is the sequence of playing actions from the moment of the service hit by the server until the ball is out of play. If the serving team wins a rally, it scores a point and continues to serve; if the receiving team wins a rally, it scores a point and gets right to serve.
- **To win a set** – A set (except the deciding fifth set) is won by the team which first scores 25 points with a minimum lead of two points. In the case of a tie, i.e. 24 each, play is continued until a two-point lead is achieved (e.g., 26–24; 27–25).
- **To win the match** – The team that wins three sets wins match. In the case of a 2-2 tie, the deciding set (the 5th) is played to 15 points with a minimum lead of 2 points.
- **Default and Incomplete Team** – If a team refuses to play after being instructed to do so, it will be declared as a default and match shall be forfeited in favour of the opponent with a result of 0–3 for the match and 0–25 for each set.
- **Rotation** – Rotation order is determined by the team's starting line-up and controlled with the service order,

### ACTIVITY 7.21

Make two teams and play a Volleyball match with points.



**ACTIVITY 7.22**

Discuss the position of players on a volley court and then draw there on chart/blackboard.

and players' positions, throughout the set. When the receiving team has gained the right to serve, its players rotate one position clock-wise: the player in position 2 rotates to position 1 to serve, the player in position 1 rotates to position 6, etc.

- **Rotational Fault** – A rotational fault is committed when the service is not made according to the rotation order. As a result the team loses rally and a point.

**7.8.4 Fundamental Skills****Service***(a) Underhand service*

**Position** – The ball is held in the left hand (for right hander), body facing the court, left leg is kept a little ahead of the right.

**Execution** – Toss the ball with the left hand and hit the ball with the right hand using the palm which is facing upwards.

**Follow through** – The hitting hand and the right leg also should follow the direction of the ball.

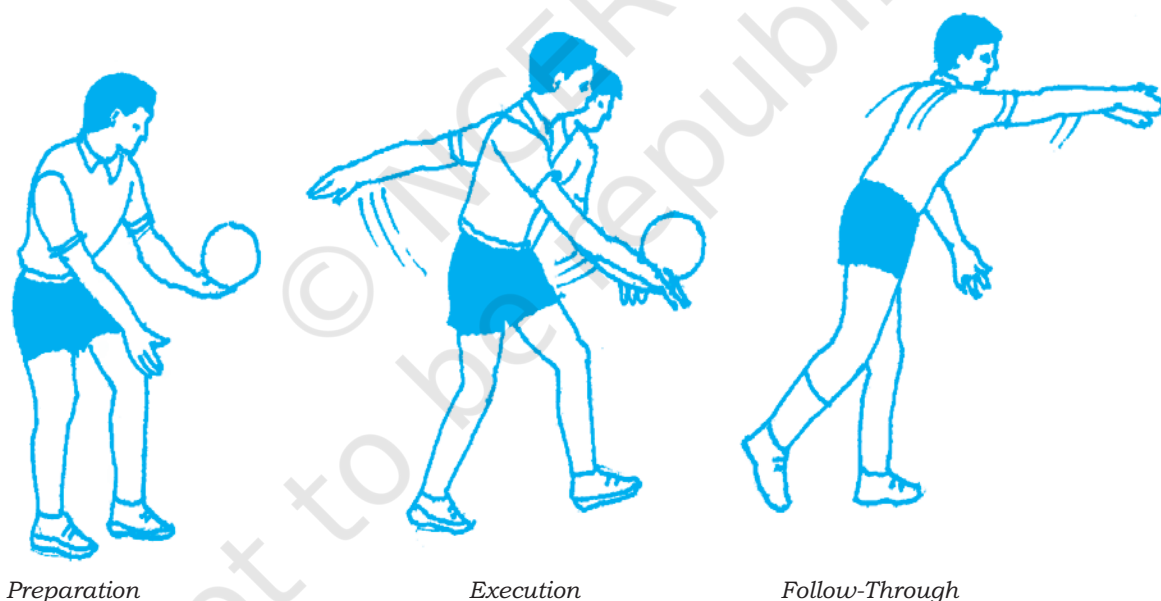

Fig. 7.31 : Volleyball serve (underhand)

*(b) Overhead service*

**Position** – Ball is held with the left hand and the feet are kept with one foot slightly ahead of the other.

**Execution** – Ball is tossed with the left hand and the right hand goes backward with the body bent slightly backward, eyes on the ball. The ball is now hit with the right hand using the palm which is facing forward and downwards.

**Follow through** – Hitting arm and the body, move forward stepping with the rear foot.

### Passing

#### (a) Underhand pass

**Position** – The player bends downwards from his knees, hands inter-locked, Both arms are kept straight without bending the elbows and one foot is slightly ahead of the other.

**Execution** – When the ball comes close to the player the movement starts from the legs (knee extension) to the arms which are fully stretched with the help of the shoulder joints Simultaneously the ball is hit from the front of fore-arms upwards.

**Follow through** – The hands follow the direction of the ball and the player comes on his/her toes.

#### (b) Overhead pass

**Position** – Move and take ready position under the ball with one foot slightly ahead of the other, knees bent and palm cup shaped, fingers kept facing upwards.

**Execution** – When the ball comes, push the ball upwards and straighten the whole body from feet to arms.

Follow through towards where you want to send the ball. The arm action should be fully tight so that the ball doesn't slip from the hands and is directed to the correct place.

### Spike or Smash (Fig. 7.32)

**Position** – In this the player takes a step forward with left foot and both the hands swinging backwards. Now the right foot joins the left foot with the forward movement of both the arms and the left hand is dropped and the right hand goes behind the body for smash.

**Execution** – The player hit the ball on the top with full hand either left or right to ground on the opponent's court with force, speed and accuracy.

**Follow through** – Land on both the feet by flexing your ankle, knees, hip, trunk etc.



Fig. 7.32 : Volleyball spiking



## ASSESSMENT

### Answer the following questions

1. Where did the game of basketball originated?
2. Who was Dr. James Naismith?
3. What are the dimensions of the basketball court?
4. Name any three fundamental skills of basketball.
5. List any two fouls in Basketball.
6. Why there is provision for substitution of players during a basketball match?
7. What is the role of the table officials in a basketball match?
8. When was the first one-day International cricket match played?
9. What is the dimensions of a cricket pitch?
10. What is an inning of cricket?
11. How a batsman gets “out” in cricket?
12. List any five rules of the football game.
13. How can playing football help us in the improvement of our health?
14. Which fundamental skills did you enjoy the most in football and why?
15. What is the name of the top most body which controls the game of football all over the world and where is its headquarter situated?
16. List the equipments required to play the game of Hockey.
17. What is the protective gear that the goalkeeper should wear?
18. What is the penalty for a player playing with the rounded side of the Hockey stick?
19. When is penalty stroke given in Hockey?
20. Write any five important rules of the Kabaddi.
21. What are the dimensions of the kabaddi court?
22. Which fundamental skills were you able to develop the best in kabaddi and why?
23. List down the factors required to improve a player’s performance in the game of kabaddi?
24. List and explain any two important rules of play Kho-kho?
25. List the chasing skills in Kho-Kho.
26. Which fundamental skill did you enjoy the most in Kho-kho and why?

27. Explain any one fundamental skill of the kho-kho game.
28. What is the name of the apex body which controls the game of Kho-kho in India?
29. How and where did the game of Volleyball originated?
30. What is a rally in Volleyball?
31. In Volleyball what is rotation and how is it determined?
32. What is an antenna in Volleyball?
33. Explain the bonus line in Kabaddi.
34. When is Lona given in Kabaddi?
35. How many players are in Kabaddi Team.

### Fill in the blanks

- (i) Free throws are attempted from a line ..... from the basket.
- (ii) In India, YMCA at Kolkata introduced basketball some .....years ago.
- (iii) Basketball originated in the year .....  
The Imperial Cricket Conference (ICC) was formed in the year .....
- (iv) The name Imperial Cricket Conference was changed to .....
- (v) An England team toured India for the first time in the year .....
- (vi) Measurement of a football field is .....
- (vii) Diameter of the football is .....
- (viii) Duration of one half in football is .....
- (ix) Duration of time out in football is .....
- (x) Measurement of hockey field is .....
- (xi) Height of the lower edge of the hockey goalpost from ground is .....
- (xii) Weight of the hockey ball is .....
- (xiii) Duration of one quarter of the hockey game is .....
- (xiv) Length of the Hockey stick is .....  
Length of kabaddi court is .....
- (xv) Width of kabaddi court is .....
- (xvi) Duration of one half in Kabaddi is .....
- (xvii) Duration of time out in Kabaddi is .....
- (xviii) Length of Kho-kho court is .....
- (xix) Width of Kho-kho court is .....
- (xx) Duration of one inning in Kho-Kho is .....
- (xxi) Measurement of Volleyball court is .....
- (xxii) Height of the upper edge of the Volleyball net from floor is .....
- (xxiii) Circumference of the Volleyball is .....
- (xiv) Length of the antenna in Volleyball is .....

**Tick (✓) mark either Yes / No**

- (i) In 1894, Naismith drew up the first 13 rules in Basketball (Yes/No)
- (ii) A jump ball in Basketball is when a referee throws the ball up at the centre circle. (Yes/No)
- (iii) A basketball team consist of five players in total. (Yes/No)
- (iv) The cricket pitch is 22 yard (20.12m) in length. (Yes/No)
- (v) The weight of the cricket ball is 150gms. (Yes/No)
- (vi) The cricket bat is 10.8cm. in width and 96.5cm. in length including the handle. (Yes/No)
- (vii) Three umpires are appointed to conduct an international cricket match. (Yes/No)
- (viii) Ten players in football are required to start a game. (Yes/No)
- (ix) Football game was invented in 1871. (Yes/No)
- (x) A player in football is to be substituted within 20 seconds. (Yes/No)
- (xi) A player in football can leave the ground at any time. (Yes/No)
- (xii) After getting a red card in football a player has to leave the ground. (Yes/No)
- (xiii) Eleven players are required to start a game in hockey. (Yes/No)
- (xiv) Hockey game was invented in 1828. (Yes/No)
- (xv) India first participated in hockey in the Olympics in 1924. (Yes/No)
- (xvi) Kho-Kho was included in Indian Olympics in 1938. (Yes/No)
- (xvii) Monkey crawl is a technique of sitting in a square. (Yes/No)
- (xviii) Trapping in kho-kho means touching an active runner by extending an arm. (Yes/No)
- (xix) A Kho-Kho match consists of three innings. (Yes/No)
- (xx) Six players are required to start a game in Volleyball. (Yes/No)
- (xxi) Volleyball game was invented in 1895. (Yes/No)
- (xxii) Player is to be substituted within 10 seconds in Volleyball. (Yes/No)
- (xxiii) Player can leave the court at any time. (Yes/No)



# Ethics in Sports

## 8

### 8.1 INTRODUCTION

It is now being increasingly realised that sports contribute to the physical, psychological and emotional well-being of an individual. Sports play a significant role in healthy social development and interaction. It helps people learn how to set and achieve goals through discipline and hard work. It nurtures the development of decision-making and leadership abilities, while teaching people to manage both success and failure. Today, it has become one of the most popular activities being organised at regular intervals. In its true sense, *sports means much more than* just to compete in a few events organised at certain intervals for the highest honour of one's state/country.

Sports is a human activity that contributes to the holistic development of individuals. It is recognised as an individual activity which offers the opportunity for self-knowledge, self-expression and fulfilment of personal achievement; skill acquisition and demonstration of ability; enjoyment, good health and well-being. Sports also engages us in a collective effort to pursue human excellence. It provides us an opportunity for social interaction. It is a source of pleasure, but more than that, sports inspires, brings cultures together, and can bridge social divides. Sports can enrich society and foster friendships between nations. Sports is also responsible for the application of rules and for adherence to values such as mutual respect, solidarity and fair play.

Sports today, faces the pressures of modern society and new challenges. When sports events like Olympic games, Common-Wealth Games, Asian Games or those related to Cricket, Football, Volleyball, Tennis, Hockey or Badminton take place, millions of spectators, viewers on television, internet or listeners on radio become intensely engaged even though a selected few participate.

Sports is primarily a competitive activity where winning is the be all and end all. Do you agree with this statement? Perhaps that is why, in this highly competitive sports environment, we quite often hear about unethical behaviour which includes cheating, bending the rules, doping, abuse of food additives, physical and verbal violence, harassment, sexual abuse and trafficking of young sportspersons, discrimination, exploitation, unequal opportunities, unethical sports practices, unfair



13149CH08

means, excessive commercialisation, use of drugs in sports and corruption.

These are just a few examples of what may go wrong with sports. There is not just one reason for these, part of the problem is that people ignore ethics while making decisions. It is in this context that ethics occupy a critical place. In the present chapter we shall discuss various dimensions of sports ethics.

## 8.2 WHAT IS SPORTS ETHICS?

Before discussing various dimensions of sports ethics, it is important to understand the meaning of ethics. Ethics, morals and values are used interchangeably in everyday language, though these terms are not synonyms. The concept of ethics is technically understood as a branch of philosophy that defines what is good for the individual and society and establishes the nature of obligations, or duties, that people owe themselves and to one another. But without going into the complexities of this concept, it is relevant to understand ethics as the practice of making principled choices between right and wrong: a code of conduct that guides human behaviour, a set of standards that guides our conduct. It is generally viewed as the system or set of rules, norms or laws by which attitudes and actions are determined to be either “right or wrong”. The fundamental problem of ethics is determining what constitutes proper conduct. It defines how individuals, professionals in different fields, organisations, associations, federation and corporations choose to interact with one another.

In view of the above, sports ethics is a positive concept that guides human action in sports. It is defined as the code of conduct for promoting and ensuring healthy sporting practices. Sports ethics signifies not just a certain form of behaviour but also a particular way of thinking. It promotes fair play among children and young persons via educational and preventive measures and encourages the dissemination of good practices to promote diversity in sport and combat all forms of discrimination.

Every child and young person has the right to play sport and games to gain satisfaction from the experience. The code of sports ethics applies to all levels of skills and commitment, recreational activities as well as competitive sport. It involves the elimination of all types of negative behaviour on and off the field. More importantly, it promotes equity and sporting excellence.

Sports ethics is also focused on equity in sport which should be an expression of human excellence. It has two dimensions:

### Box 8.1

Ethics is much more than playing within the rules, as it covers notions such as friendship, respect for others and the sporting spirit.

### Box 8.2

Institutions and adults must be the guarantors of the right to play sport and games.

- (a) **Institutional:** Discrimination based on criteria other than performance must be rejected, rules must be applied uniformly and without resorting to arbitrary decisions;
- (b) **Personal:** There is a moral obligation to abide by the rules, in accordance with the principles of fair play. It tries to ensure that sporting excellence must be an expression of human excellence and performance and results should emerge from the deserved and meritorious development of individual talent. The codes of sports ethics documented by the Olympic Committee and other international and national sports bodies, governments, sports federations and associations, sports sponsoring concerns and specialised research institutions provide a comprehensive view of sports ethics. These clearly suggest that sports ethics is a set of standards that guide the conduct of all concerned with sports — the sports persons, trainers, referees, managers, administrators, parents, teachers, journalists, doctors and pharmacists, nutritional expert, sports sponsoring concerns, top level sportspersons who serve as models and even spectators. These ethical standards are universal and objective and are not based on subjective guidelines. They have been proven over time.

### ACTIVITY 8.1

- Gather information from the literature on sports regarding the codes of sports ethics developed, documented and issued by various sports bodies at global and regional levels.
- Collect such codes of sports ethics documented by government and sports bodies in India.
- Compare the international and Indian codes of sports ethics.

## 8.3 SPORTS ETHICS: STANDARDS

What are sport ethics or standards? Commonly described as six pillars of fair play, Standards are integral elements of all sports activities, sports policy and management, and apply to all levels of ability and commitment, including recreational as well as competitive sports. These are: trustworthiness, respect, responsibility, fairness, caring and citizenship.

### 8.3.1 Trustworthiness

- Always pursue victory with honour.
- Demonstrate and demand integrity.
- Observe and enforce the spirit and letter of the rules.
- Do not engage in or tolerate dishonesty, cheating, or dishonourable conduct.

### 8.3.2 Respect

- Treat the traditions of the sports and other participants with respect.

- Do not engage in or tolerate disrespectful conduct, including verbal abuse of opponents and officials, taunting and inappropriate celebrations.
- Win with grace and lose with dignity.

### 8.3.3 Responsibility

- Be a positive role model on and off the field.
- Safeguard your health. Know what you're putting in your body. Just because a substance is legal or natural doesn't mean it's permitted or safe in health context.
- Take responsibility and educate yourself about issues of anti-doping. It's up to you to comply with anti-doping policies.

### 8.3.4 Fairness

- Adhere to high standards of fair play.
- Ensure that teams and athletes play by the rules and treat others fairly.
- Anything that gives an unfair advantage violates the spirit as well as the integrity of the sport.

### 8.3.5 Caring

- Demonstrate concern for others. Never engage in careless behaviour that could injure yourself or others.
- Help the team by encouraging your teammates.
- Never tolerate unhealthy or dangerous conduct by your teammates. Encourage your teammates to make healthy choices and be prepared to report any dangerous behaviour.

### 8.3.6 Citizenship

- Play by the rules. Sports is defined by the rules. These rules may be yours or your team's or your teacher's.
- Follow the spirit of the rules. Resist the temptation of gaining an advantage by bending the rules. Take pride in your performance while abiding by the rules. You have worked too hard to throw it away by cheating.
- As a member of a community, whether in a team, in a classroom, or with a family, think how your choices impact other community members.

## ACTIVITY 8.2

Write a report about your own experience on sports ethics regarding any competition held in the neighborhood or at the school level.

## 8.4 RESPONSIBILITY FOR OBSERVANCE OF SPORTS ETHICS

The responsibility to ensure observance of sports ethics belongs to all those who are directly or indirectly, associated with sports and especially those who influence and encourage the involvement and participation in sports. These include:

- Governments at all levels, including the agencies working with governments.

- Sports-related organisations including sports federations and governing bodies, sports sponsoring concerns, physical education associations, coaching agencies and institutes, medical and pharmacological professions and mass media.
- The commercial sector, including sports goods manufacturers and retailers, sponsoring concerns and marketing agencies; and
- Individuals including parents, teachers, coaches, referees, officials, sports leaders, physical education expert, administrators, journalists, doctors and pharmacists and those role models who have achieved levels of sporting excellence and fame; those who work on a voluntary or on a professional basis. Individuals may also have responsibilities in their capacity as spectators.

Each of these institutions and individuals have a responsibility and a role to play. This code of sports ethics is addressed to each one of them. This can be effective if all involved in sports are ready to take on the responsibility identified in the code.

#### 8.4.1 Government

Government has the following responsibilities:

- to encourage and follow ethical standards in all areas of society where sports are conducted;
- to improve controls with regard to integrity and ethics in funding of amateur and leisure sport;
- to stimulate and support those organisations and individuals who have demonstrated ethical principles in their sports-related activities;
- to cooperate in promoting and monitoring the implementation of the code of sports ethics;
- to empower and encourage physical education and sports teachers and instructors to promote sports ethics in school curricula and refer to the positive contribution of sports to humankind and society;
- to commit in preserving the integrity of sports under threat especially from match fixing, trafficking in young sportsperson and illegal betting;
- to support, as far as possible, all initiatives aimed at promoting sports ethics, particularly among youths, and encouraging institutions to make sports ethics a central priority;
- to continue to promote, in cooperation with the sports movement, the promotion and monitoring of the prevention of racism, xenophobia (hatred and fear of one another) and racial intolerance in sport;



- to encourage research, both nationally and internationally, in order to improve our understanding of the complex issues surrounding young people's involvement in sports; and
- to identify the opportunities for promoting sports ethics.

#### **8.4.2 Sports-related Organisations**

Sports-related organisations have the following responsibilities:

##### *A. Concerning the framework and context of sports ethics*

- to publish clear guidelines on what is considered to be ethical or unethical behaviour and to ensure that, at all levels of participation and involvement, consistent and appropriate incentives and/or sanctions are applied;
- to ensure that all decisions have been taken in accordance with a code of ethics for sports;
- to raise awareness of the concept of sports ethics within their sphere of influence by means of campaigns, awards, educational materials and training opportunities. Such initiatives should be closely monitored and their impact evaluated;
- to establish systems which reward sports ethics and personal levels of achievement in addition to competitive success;
- to consider and formulate rules governing the right to participate in competitions and the organisation of categories in competitions in the light of the principles of sports ethics; and
- to assist and support the mass media in highlighting the contribution made by sports ethics to education and society.

##### *B. Concerning work with young people*

- to ensure that the structure of competition acknowledges the special requirements of growing children and young people and provides the opportunity for graded levels of involvement from recreation to high-level competition;
- to encourage modification of the rules to meet the special needs of young people and put the emphasis not only on success in competition but also on sports ethics;
- to ensure that safeguards are in place within the context of an overall framework of support and protection for children, young male/female, both to protect them from sexual harassment and abuse and to prevent the exploitation of children, those with gifted abilities; and children with special needs.
- to ensure that including those associated with a sports organisation, who bear the responsibility for children and

young people are qualified at an appropriate level to guide, train and educate them. It is also to be ensured that they understand the physiological and psychological changes associated with the child's process of development and that they are familiar with and take into account the emotional and relational functioning of human beings.

### 8.4.3 Individuals

Individuals have the following responsibilities:

#### A. Concerning personal behaviour

- to behave in a way which sets a good example and presents a positive role model for children and young people;
- to refrain, in all circumstances, from rewarding unfair play, demonstrating it personally or condoning it in others and to take appropriate sanctions against such behaviour; and
- to ensure that their own level of training and qualifications is appropriate to the needs of the child at the different stages of sporting commitment.

#### B. Concerning work with young people

- to make the health, safety and welfare of the child or young sportspersons is the first priority and ensure that such considerations come before everything else, i.e., reputation of the school, club, coach or parents;
- to extend the initiatives taken by the international federations and organisations in order to promote quality standards in the activity of sports agents;
- to provide a sporting experience for children that encourages a life-long commitment to healthy physical activity;
- to avoid treating children as small adults, but be aware of the physical and psychological changes which accompany their development and how these affect sporting performance;
- to avoid placing expectations on children which they are unable to meet;
- to make the participant's pleasure and enjoyment the priority and never exert undue pressure on the child which impinges on their right to freely choose to participate;
- to take the same level of interest in all young people regardless of their talent and emphasise and reward personal levels of achievement and skill acquisition in addition to competitive success;

- to be attentive and responsive to children’s needs, so that each child feels appreciated as an individual, irrespective of his or her sporting prowess;
- to encourage young children (a) to devise their own games with their own rules, to take on the roles of coach, teacher, official or referee in addition to that of participant; (b) to devise their own incentives and sanctions for fair or unfair play; and (c) to take personal responsibility for their actions;
- to provide young people and their families with as much information as possible to ensure awareness of the potential risks and attractiveness of reaching high levels of performance.

### ACTIVITY 8.3

The intent of this exercise is not to tell you what is right or wrong. These are just a few examples of ethical choices that sports provide. Out of the four options against each example, tick one out of four choices. Remember, it is important for you to decide what you will do when faced with these choices. Be proactive by setting your standards before you get to the heat of the competition.

Sl. No	Practical Examples	Clearly Ethical	Somewhat Ethical	Somewhat Unethical	Clearly Unethical
1.	In a basketball game, the coach tells the team to be as physically aggressive as they can and get away with it.				
2.	In football, a lineman deliberately seeks to inflict pain on an opposing player to intimidate him.				
3.	At a crucial point in a big game, a player fakes an injury to get a needed time-out for the team.				
4.	In tennis, the ball is called out though the player is certain it hit the line. The player says nothing and takes the point.				
5.	There is a loud appeal for caught behind, which was denied by the umpire. But the batsman goes back to pavilion, as he/she knows his/her bat had touched the ball.				

6.	A coach uses bad words and personal insults while coaching.				
7.	In soccer, the best player on the other team already has a yellow card. As an opponent you deliberately fake a foul hoping that player will be given a red card and removed from the game.				
8.	The team captain argues with an official intending to influence future calls.				
9.	Coming back from an injury, an athlete uses prohibited substances – not to get ahead – just to get back to where he/she was before the injury.				
10.	You know your teammate is doping and you do not confront him/her or anonymously report about it.				
11.	An athlete takes 25 different supplements with the intent to enhance the performance. None of the supplements have any prohibited substances listed on the label.				
12.	During a cricket match, some of the spectators move into the field and manhandle the umpire, because he/she has given LBW decision against a batsman who was in reality not out.				

## ASSESSMENT

### Answer the following questions

1. Explain ethics in sports.
2. What is the importance of ethics in sports?
3. Write about the various standards of sports ethics.
4. Explain the responsibilities of Government regarding sports ethics.
5. Write about the role of sports related organisations with respect to sports ethics.

### Fill in the blanks

- (i) Sports is recognised as an.....activity.
- (ii) Sports provides opportunity for .....interaction.
- (iii) Ethics, morals and values are used ....in daily life.
- (iv) Sports ethics signify not just a certain form of ..... but also a particular way of .....
- (v) Code of sports ethics promotes ..... and sports.....

### Tick (✓) mark either Yes / No

- (i) Truth worthiness is one of the standard of ethics. (Yes/No)
- (ii) Governments encourage adopting high ethical standard in society through sports. (Yes/No)
- (iii) Sports organisation formulates rules of the competition in the light of sports ethics. (Yes/No)
- (iv) Always adhere to the high standard of fair play. (Yes/No)
- (v) There are six standards of fair play. (Yes/No)



# Personality Development Through Yoga

9

## 9.1 INTRODUCTION

Development of personality is an important issue. Personality starts developing since birth, but it assumes great importance during adolescence, when reorganisation of personality takes place.

Personality is a very common term which is used in our day-to-day life. It tells us what type of person one is. We know that each person generally behaves consistently in most of the situations. The examples of this consistency can be seen in a person who remains friendly or a person who is generally kind or helpful in most situations. Such a consistent pattern of behaviour is termed as personality. It can be called as the sum total of behaviour that includes attitudes, emotions, thoughts, habits and traits. This pattern of behaviour is characteristic to an individual.

There are various dimensions of personality. These dimensions are related to physical, emotional, intellectual, social and spiritual aspects of our behaviour. For a holistic personality development, yoga plays an important role.

## 9.2 YOGA AND PERSONALITY DEVELOPMENT

Yogic practices are found effective for development of all dimensions of personality.

Let us talk about the yogic practices that influences development of different dimensions of personality.

**Yoga and Physical Dimension of Personality:** Physical dimension is related to our body. It means that all organs and systems of our body should be properly developed and function. It implies a healthy body without any disease. Yogic practices like *asana*, *pranayama*, and *bandha* play a beneficial role in physical development of children. There is a series of *asanas* and *pranayamas* which help to improve the functioning of the body.

**Yoga and Emotional Dimension of Personality:** Yogic practices are effective for development of emotional dimension related to our feelings, attitudes and emotions. There are two kinds of emotions : positive and negative. For example love, kindness are positive emotions, while anger and fear (exam phobia) are



13149CH09

negative emotions. Similarly, our feelings and attitudes may be positive and negative. For emotional development, positive feelings, attitudes and emotions should be developed and negative ones should be controlled, as the negative attitudes and emotions work as a mental block for the development of personality. Yoga plays a critical role in development of positive emotions. It brings emotional stability. It helps to control negative emotions. Yogic practices such as *yama*, *niyama*, *asana*, *pranayama*, *pratyahara* and meditation help in emotional management. For example, the principle of non-violence will protect us from negative emotions and develop positive feelings of love and kindness. Similarly, other principles of *yama* and *niyama* will help to develop positive emotions and attitudes in our personal and social life and therefore help in the management of emotions.

**Yoga and Intellectual Dimension of Personality:** Intellectual development is related to the development of our mental abilities and processes such as critical thinking, memory, perception, decision making, imagination, creativity, etc. Development of this dimension is very important as it enables us to learn new things and acquire knowledge and skills. Yogic practices such as *asana*, *pranayama*, *dharana*, *dhyana* (meditation) help to develop concentration, memory and thereby help in intellectual development.

**Yoga and Social Dimension of Personality:** Primary socialisation, probably the most important aspect of the personality development takes place during infancy, usually within the family. By responding to the approval and disapproval of parents and grandparents and imitating their examples, the child learns the language and many of the basic behaviour patterns of her/his society. The process of socialisation is not limited to childhood, but continues throughout life and teach the growing child and adolescent about the norms and rules of the society in which she/he lives . Some key elements of this process include respect for others, listening carefully to other persons, being interested in them, and voicing your thoughts and feelings politely, honestly and clearly so that you can be easily heard and understood. Principles of *yama* include these key elements and are very important as these help us in the betterment of our relationships with our friends, parents, teachers and others.

**Yoga and Spiritual Dimension of Personality:** This dimension is related to the development of values. It is also concerned with self-actualisation which is related to recognising one's potential and developing them to the maximum. Proper

development of this dimension helps the person to realise one's true identity. For spiritual development, *yama*, *niyama*, *pratyahara* and *dhyana* (meditation) are helpful. *Yama* and *niyama* help to develop our moral values while *pranayama*, and meditation help us to realise our true self. Introspection is very effective for the development of 'self'.

### **Yama (Restraint) and Niyama (Observance)**

*Yama* and *Niyama* are principles which need to be adopted always in our day-to-day life. These can be considered as the universal codes of conduct that help us in following high standards in our personal and social life. Principles of *yama* are concerned with one's social life; while the principles of *niyama* are concerned with one's personal life. *Yama* and *niyama* are part of *Ashtanga yoga*.

The five principles of *yama* are: *Ahimsa* (non-violence), *Satya* (truthfulness); *Asteya* (non-stealing); *Brahmcharya* (abstinence) and *Aparigraha* (non-collectiveness).

The five principles of *niyama* are: *Shaucha* (cleanliness); *Santosha* (satisfaction); *Tapas* (austerity); *Swadhyaya* (study of good literature and knowing about the 'self') and *Ishwarpranidhana* (dedication to the God/Supreme power).

## **9.3 YOGIC PRACTICES FOR PERSONALITY DEVELOPMENT**

In the following section, we will discuss some yogic practices which contribute to the development of various dimensions of personality.

We begin with *Surya Namaskara*. Prepare the body by performing yogic micro practices.

### **9.3.1 Surya Namaskara (Sun Salutation)**

*Surya* means 'sun' and *namaskara* means 'salutation' or 'bowing down'. It consists of 12 postures. The regular practice of *surya namaskara* helps improve blood circulation throughout the body and maintain health, and thereby helps one to remain disease-free. Postures practised during *surya namaskara* act as a good link between warm-ups and *asanas*. *Surya namaskara* should preferably be done at the time of sunrise. It can be done any time on an empty stomach. However, morning is considered to be the best time for it. Adolescents should start doing *surya namaskara* daily to have healthy body and mind.

Let us perform *surya namaskar* by following the steps given below:

1. Stand erect with legs together and hands by the sides of the body. Bring both the arms to the chest with palms together in the prayer posture (*Namaskarasana*).
2. Inhaling, raise both the arms above the head. Stretching bend the trunk backwards (*Hastottanasana*).



1.

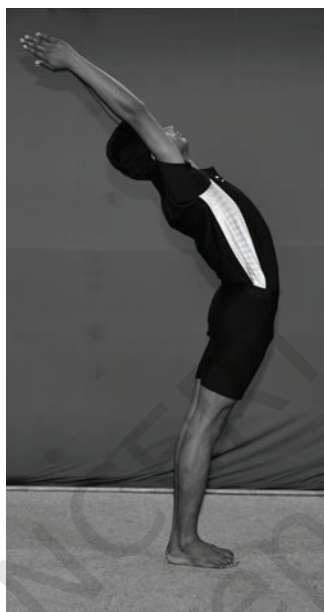

2.



3.



4.



5.

3. Exhaling, bend the trunk forward and place the hands on the floor besides the feet and forehead near the knees (*Padahastanasana*).

4. Inhaling, stretch the right leg backward and bend the left leg at the knee. Tilt the head backward and, look up while arching the spine (*Ashwasanchalanasana*).

5. Stretch the left foot backward by the side of right foot, lower your head and move buttocks upwards. Keep arms and legs straight and heels on the floor (*Parvatasana*).

6. Lower the knees, chest and chin to the floor. Keep the hips slightly up. The toes, knees, chest, hands and chin should be touching the floor (*Ashtanga namaskara*).

7. Lower the hips. Raise the head and torso up to the navel region. Bend the head backwards (*Bhujangasana*).



6.



7.

8. Lower the head and trunk to the floor, now raising the buttocks and straightening the arms, bring feet towards the head. Head should be between the arms. Come to the position 5 (*Parvatasana*).
9. By bending the left leg, bring it to the front between the hands. Take the right leg behind with knee touching the floor. Keep palms on both the sides of the left foot and head tilted backward and back arched. Look up (*Ashwasanchalanasana*).
10. Exhaling, bring the right leg forward and keep it by the side of left leg. Keep the hands on the floor on sides of the feet and head near the knees (*Padahastanasana*).



8.

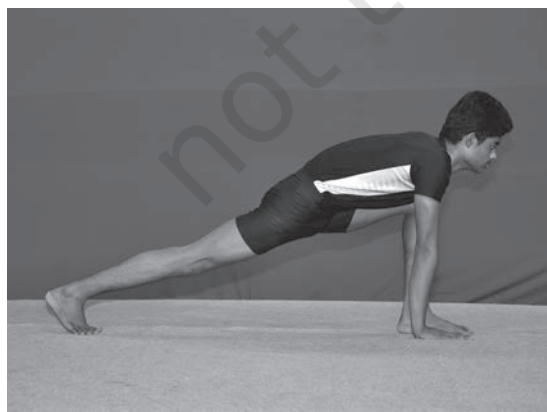

9.



10.



11. Inhaling, raise both the arms above the head and bend the trunk backwards (*Hastottanasana*).
12. Come to the erect and straight position. Join both palms in prayer posture (*Namaskarasana*).



11.

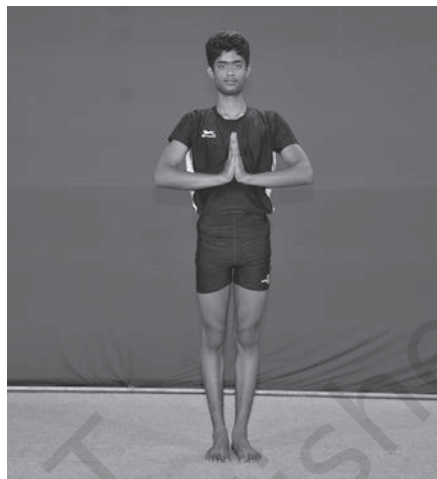

12.

### Benefits

- It helps to increase strength, endurance and flexibility.
- It regulates all the systems of the body.
- It improves concentration.
- It helps in removing excess fat.
- It helps in constipation and improve blood circulation in the body.
- It energises the body.
- It helps in increasing the height of the growing children and toning up the body.
- It revitalises the body and refreshes the mind.
- It stretches abdominal organs and improves digestion.

### Limitation

One should avoid practising *surya namaskara* in case of high blood pressure, fever, heart diseases, hernia, slipped disk, intestinal tuberculosis and sciatica.

## 9.4 ASANAS

We all know that *asanas* are beneficial for our physical and mental development. You have also learnt so many *asanas* in previous classes. Now, we will discuss some more *asanas* in this section.

### 9.4.1 Tadasana (Palm tree posture)

*Tada* in Sanskrit means ‘palm tree’. This is called *Tadasana* because in this *asana* the student stands straight like a palm tree. Hence, it has been named *Tadasana*.

**Let us perform *Tadasana* by following the steps given below:**

1. Stand erect, feet together, hands by the side of the thighs. Keep the back straight and gaze in front.
2. Stretch the arms upward, keep them straight and parallel with each other in vertical position, with the palms facing inward.
3. Slowly raise the heels as much as you can and stand on toes. Stretch body up as much as possible. Maintain the position for 5-10 seconds.
4. To come back, bring the heels on the floor first. Slowly bring down the hands by the side of the thighs and relax.



**Remember the following points:**

Dos	Don'ts
<ul style="list-style-type: none"> <li>• The inner upper arms should be touching the respective ears.</li> <li>• Stretch the arms and fingers fully.</li> <li>• Keep the head, neck and the body in one straight line.</li> </ul>	<ul style="list-style-type: none"> <li>• Do not bend forward or backward.</li> </ul>

**Benefits**

- It gives vertical stretch to whole body muscles.
- It strengthens thighs, knees and ankles.
- It helps improve height of the children.
- This posture plays an important role in increasing one's self-awareness.
- It helps to remove laziness and lethargy.

**Limitation**

- Those having complaints of vertigo should not practise this *asana*.

**9.4.2 Katichakrasana (Lumber Twist Posture)**

*Kati* in Sanskrit means 'waist' and *chakra* means 'wheel'. In this *asana*, the waist is moved towards right side and left side. The movements of the waist along with arms look like a wheel. Hence, it is called *Katichakrasana*.

**Let us perform *Katichakrasana* by following the steps given below:**



1. Stand erect on the ground with feet 12 inches apart.
2. Now, keep the arms out-stretched in front of the body with palms facing each other at the shoulder level.
3. While inhaling, swing the arms slowly towards right side of your body.
4. Twist your body from the waist to the right and take your arms back as far as possible.
5. While swinging towards right side, keep the right arm straight and left arm bent.
6. Repeat the practice twisting toward left side as well.

**Remember the following points:**

Dos	Don'ts
<ul style="list-style-type: none"> <li>• Right hand is kept straight while twisting to the right and vice versa.</li> <li>• Fingers should be stretched out. Inhale while twisting towards back and exhale while coming to the normal position.</li> <li>• In the final position of <i>asana</i> gaze behind.</li> </ul>	<ul style="list-style-type: none"> <li>• Don't bend forward or backward.</li> <li>• Don't move the lower part of the body.</li> <li>• Do not jerk the body.</li> </ul>

**Benefits**

- It helps in making slim.
- It relieves constipation and makes the lumber region strong.
- It is good for respiratory ailments. Tuberculosis of lungs can be prevented.
- It strengthens shoulders, neck, arms, abdomen, back and thighs.

**Limitation**

- Do not practise it if suffering from chronic spinal pain or injury.

**9.4.3 Simhasana (Lion Posture)**

In Sanskrit *Simha* means 'lion'. In this *asana*, the face with open mouth and tongue stretched out towards the chin resembles the fierce look of a lion, hence, it is called *Simhasana*.

**Let us perform *Simhasana* by following the steps given below:**

1. Sit in *Vajrasana* with palms on the respective knees.
2. Keep the knees apart.
3. Place both the heels upwards under perineum.
4. Place both the palms on the respective knees widely spreading out the fingers.
5. Lean forward and place the palms on the floor between the knees.
6. Open the mouth and stretch out the tongue as much as possible and gaze at *bhrumadhya* (centre of eyebrows).
7. Release the *bhrumadhya* dristi and relax your eyes.
8. Come to *Vajrasana* by placing the palms on the respective knees and relax.



**Remember the following points:**

Dos	Don'ts
<ul style="list-style-type: none"> <li>• The knee should rest on the ground.</li> <li>• Sit on the heels.</li> <li>• The buttocks are to be lifted up.</li> <li>• The fingers should be spread out in imitation of the lion's paws.</li> </ul>	<ul style="list-style-type: none"> <li>• Do not protrude the tongue beyond the capacity.</li> </ul>

**Benefits**

- It is beneficial for the muscles of the face and neck.
- The tongue becomes more elastic and healthier.
- Salivary glands become strong.
- It regulates functioning of thyroid.
- It helps in reducing dullness and depression and improves slurring of speech.

**Limitation**

- Do not practise if suffering from backache, arthritis of hip and knee, throat problems and pain in jaws.

**9.4.4 Mandukasana (Frog Posture)**

*Manduka*, a Sanskrit word means 'frog'. In this *asana*, the final posture resembles the shape of a frog. Hence, it is named *Mandukasana*.

**Let us perform *Mandukasana* by following the steps given below:**



1. Sit in *Vajrasana*.
2. Make the fists with thumbs inside and put them near navel and press the navel area.



3. Exhale slowly, lean forward from the waist, lower the chest, so that it rests on the thighs.
4. Keep the head and neck raised and gaze in front.
5. Maintain the position comfortably for 5-10 seconds.
6. To release the posture, come back to the sitting position by raising the trunk; remove your fists from the navel area and sit in *Vajrasana*.



**Remember the following points:**

Dos	Don'ts
<ul style="list-style-type: none"> <li>• Keep the head and neck raised in final position.</li> <li>• Look in the front.</li> <li>• Put pressure on the navel area.</li> </ul>	<ul style="list-style-type: none"> <li>• Do not lean beyond the capacity.</li> <li>• Do not jerk the body while leaning forward.</li> </ul>

**Benefits**

- This *asana* is beneficial for the people having heavy bellies, thighs or hips.
- It eliminates gases from the abdomen.
- It benefits people suffering from constipation, diabetes and digestive disorders.

**Limitation**

- Person with slipped disc, lumber spondylitis or any other major disease of the spine should not practise this *asana*.

**9.4.5 Uttana-mandukasana**

**(Stretched up Frog Posture)**

*Uttana* means ‘upright’ or ‘stretched up’ and *manduka* means ‘frog’. In final position of this *asana*, the body looks like a stretched up or upright frog, hence, it is called *Uttana-mandukasana*.

**Let us perform *Uttana-mandukasana* by following the steps given below:**

1. Sit in *Vajrasana*.
2. Keep both the knees wide apart to such an extent that toes of both the feet touch each other. The head, neck and trunk are kept erect. The eyes are either closed or kept open.
3. Raise the arms above the head, fold them and take them behind.
4. Place the right palm below left shoulder and left palm below right shoulder.
5. Maintain this position comfortably for 5-10 seconds.
6. To come back, remove the arms one by one, bring the knees together and come to *Vajrasana*.

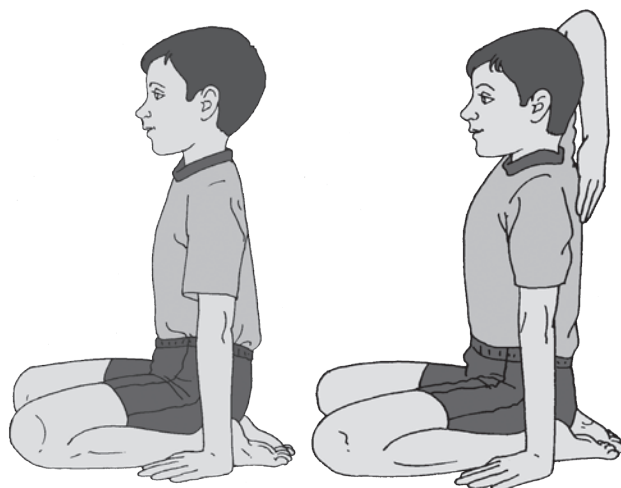

**Remember the following points:**

Dos	Don'ts
<ul style="list-style-type: none"> <li>The head is surrounded by the elbows.</li> <li>Keep the spine and neck erect.</li> </ul>	<ul style="list-style-type: none"> <li>Do not bend the arms.</li> <li>Do not lean forward.</li> </ul>

**Benefits**

- It helps in reducing backache.
- It improves the blood circulation in the chest and abdomen.
- It tones the abdominal and shoulder muscles.
- It improves the functioning of lungs by improving the movements of diaphragm.

**Limitation**

- Those suffering from chronic knee pain and piles should avoid this *asana*.

**9.4.6 Kukkutasana (Cockerel Posture)**

This is called *Kukkutasana* because this *asana* imitates the posture of a cock. This is a balancing posture, therefore, it should be practised with caution. Before taking up this practice, one must have sufficient practice of *Padmasana*.

**Let us perform *Kukkutasana* by following the steps given below:**

- Sit in *Padmasana*. Keep your hand on side.
- Now insert the arms between calves and thighs until the palms reach the floor.
- Inhaling, lift the body up as high as possible in the air. Support and balance the body on the hands. Keep the neck and head straight.
- Maintain the position with normal breath comfortably for 5-10 seconds.
- To release the posture, exhaling lower the body and bring it to the floor. Take the inserted arms out and sit in *Padmasana*.



**Remember the following points:**

Dos	Don'ts
<ul style="list-style-type: none"> <li>• Keep the head straight and eyes on fixed in front.</li> <li>• Keep palms apart firmly on the ground while fingers pointing forward.</li> <li>• Body should be balanced on the arms.</li> <li>• Hold the back straight.</li> </ul>	<ul style="list-style-type: none"> <li>• Do not bend forward.</li> <li>• Do not bring the fingers close.</li> <li>• Do not bend the head or neck.</li> </ul>

**Benefits**

- This posture helps to strengthen the shoulder, arms and elbows.
- This posture also helps to develop a sense of balance and stability.
- This makes the body strong.

**Limitation**

- People suffering from heart disease or high blood pressure should not practise this *asana*.

**9.4.7 Akarna Dhanurasana (Bow and Arrow Posture)**

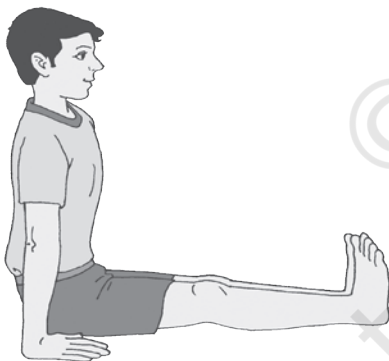

*Akarna* means 'ear' and *Dhanur* means 'bow'. In this *asana*, the posture resembles like a 'bow'. In this posture, hand is pulled up to ear like pulling a bow and arrow. Hence, this is called *Akarna Dhanurasana*.

**Let us perform Akarna Dhanurasana by following the steps given below:**

1. Sit and stretch out both the legs in front. Keep both the arms by the side of the body. Palms should be resting on the ground, fingers together pointing forward.
2. Catch hold of the right big toe by the hook of the index finger and thumb of the left hand.
3. Make the hook with the help of index finger and thumb of right hand. Clasp the big toe of the left leg.
4. Bend the right leg at knee. Pull the feet by the toe, so as it reaches up to the left ear.
5. Maintain the position for 5 to 10 seconds.



6. To come back, lower the right foot, release the hand and keep it by the side. Now bring the left leg on the floor. Release the right hand and keep it by the side of the body.

(Do it from other side changing the position of legs and hands.)

**Remember the following points:**

Dos	Don'ts
<ul style="list-style-type: none"> <li>• Keep the trunk and head erect.</li> <li>• While bending the leg, the arms should be straight.</li> <li>• Pull the foot up to ear as much as you can.</li> </ul>	<ul style="list-style-type: none"> <li>• Do not jerk or strain.</li> <li>• In the beginning do not pull the foot up to ear.</li> </ul>

**Benefits**

- This *asana* is beneficial in constipation and indigestion.
- It strengthens the abdominal muscles, muscles of arms and legs.
- It makes the legs supple.

**Limitation**

- Do not practise, if suffering from spinal complaints, dislocation of hip joints and sciatica.

### 9.4.8 Matsyasana (Fish Posture)

In Sanskrit, *Matsya* means 'fish'. In final posture of this *asana*, the body takes shape of a floating fish. The folded legs resemble the tail of a fish, hence, it is called *Matsyasana*. This *asana* should be performed under the supervision of an expert.

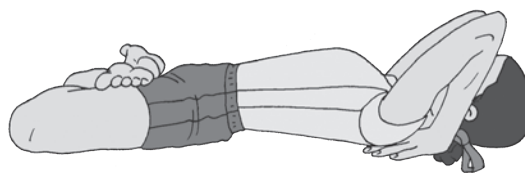

**Let us perform Matsyasana by following the steps given below:**

1. Sit in *Padmasana*.
2. Lie on the back with support of the elbows.
3. Lift the neck and chest slightly up; the back should be arched and raised from the ground.
4. Bend the head backward and place the crown of the head on floor.

5. Make hooks with the index fingers of both hands; and clasp the big toes with hooks of opposite hands.
6. Maintain the position for 10-15 seconds or as long as comfortable.
7. To come back, release the toes; place hands on the ground; raise head up with the support of hands. Sit with the help of the elbows.

**Remember the following points:**

Dos	Don'ts
<ul style="list-style-type: none"> <li>• Try to make the maximum arch of the spine.</li> <li>• Keep the arms bent at the elbows.</li> <li>• The crown of head must touch the floor.</li> <li>• The knees must touch the ground.</li> </ul>	<ul style="list-style-type: none"> <li>• Do not allow the knees to come up from the ground while arching the back.</li> <li>• While leaning backward, do not strain.</li> </ul>

**Benefits**

- It improves blood supply to the brain.
- It regulates the functioning of thyroid gland and improves immune system.
- It alleviates backache and cervical spondylitis.
- It divert the blood from the legs to the pelvic region and helps to increase the tone of the abdominal muscles.
- It is beneficial in lungs and respiratory disorders.

**Limitation**

- Avoid practising this *asana* in case of vertigo, cardiovascular diseases, hernia, arthritis, knee and ankle and spinal problems.

**9.4.9 Bhujangasana (Cobra Posture)**

*Bhujangasana* comprises two words- *bhujanga* and *asana*. In Sanskrit, *bhujanga* means cobra (snake) and *asana* means posture. In the final position of this *asana*, the body resembles the shape of a hooded snake, hence the posture is called *Bhujangasana*.

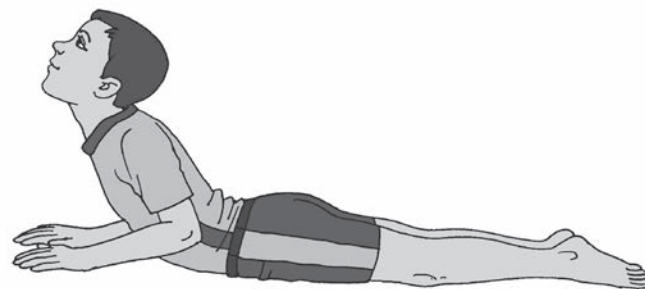

**Let us perform *Bhujangasana* by following the steps given below:**

1. Lie prone on the ground with forehead touching the floor; legs together, hands by the side of thighs.



2. Fold the hands at elbows and place the palms by the side of the shoulders, thumbs under armpits, with tip of the fingers not crossing the shoulder line.
3. Inhaling, slowly raise the head, neck and shoulders. Shoulders should be shrugged backwards.
4. Raise the trunk up to the navel region. Raise the chin as high as possible.

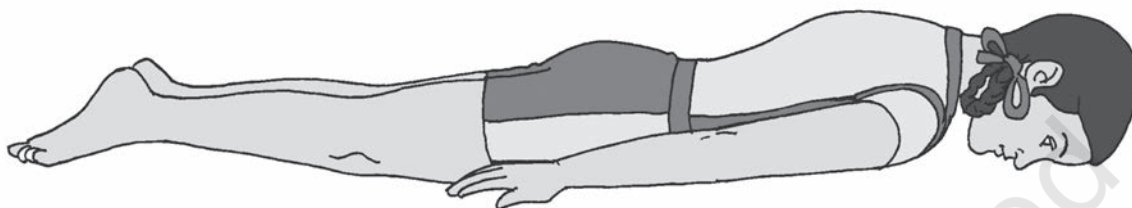

5. Eyes should be kept gazing upward.
6. Maintain the position for 5 -10 seconds or as long as comfortable.
7. To come back, bring down the upper part of navel region, chest, shoulders, chin and head.
8. Place the forehead on the ground and arms along the body, hands by sides of the thighs. Relax.

**Remember the following points:**

Dos	Don'ts
<ul style="list-style-type: none"> <li>• Put minimum weight on hands.</li> <li>• Distribute weight on the back. The trunk should be raised up to the navel only.</li> <li>• While raising, shoulders should be shrugged backwards.</li> </ul>	<ul style="list-style-type: none"> <li>• Do not give jerk to lift the body.</li> <li>• Do not allow the elbows to spread out.</li> <li>• Do not raise the region beyond the navel region.</li> </ul>

**Benefits**

- It affects the spinal column and makes it flexible.
- It solves digestive complaints.
- It increases intra-abdominal pressure benefiting the internal organs especially the liver and kidneys.
- It relaxes both body and mind.

**Limitation**

Those suffering from hernia, peptic ulcer, intestinal tuberculosis and acute abdominal pain should avoid this practice.

### 9.4.10 Makarasana (Crocodile Posture)

The posture is called *Makarasana* as the body resembles the shape of *makara*, which in Sanskrit means ‘crocodile’. *Makarasana* is a relaxing *asana* to body and mind and is very beneficial for reducing stress.

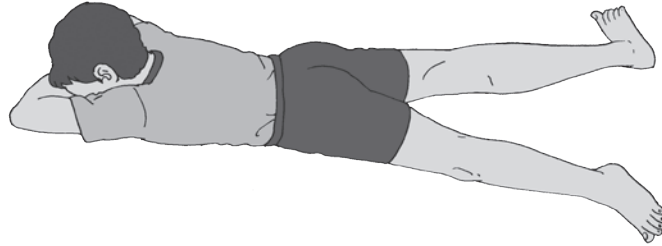

**Let us perform *Makarasana* by following the steps given below:**

1. Lie down on your stomach.
2. Keep the legs at a comfortable distance with heels inside and toes pointing outward.
3. Fold arms at elbows, and keep them under the head.
4. Place the head on the cushion of the arms, close the eyes and relax.
5. To come back bring the arms along the body and legs together.

**Remember the following points:**

Dos	Don'ts
<ul style="list-style-type: none"> <li>• Both elbows can be kept slightly apart if found difficult to put one above the other.</li> <li>• Do a deeper abdominal breathing.</li> </ul>	<ul style="list-style-type: none"> <li>• Do not press the chest hard on the ground so that the breathing becomes uncomfortable.</li> <li>• Do not bring the feet together.</li> </ul>

#### Benefits

- Traditionally it is a relaxing posture.
- It is beneficial in almost all psychosomatic disorders.
- It is beneficial for respiratory organs, as well as digestive organs.

#### Limitations

- Those having complaint of obesity and cardiac problems should avoid this practice.

### 9.4.11 Shalabhasana (Locust Posture)

This *asana* is named after the locust. In Sanskrit *Shalabha* refers to ‘locust’ and *asana* means ‘posture’. In the final posture of this *asana*, body resembles a locust.



**Let us perform *Shalabhasana* by following the steps given below:**

1. Lie flat on the stomach, legs together, hands by the side of the thighs, palms facing downward and heels together. Chest and forehead should be placed on the ground.
2. Place both palms under the thighs.
3. Stretch the chin slightly forward and keep it on the floor.
4. Inhaling and pressing the palms on the ground, raise both the legs upward as high as possible.

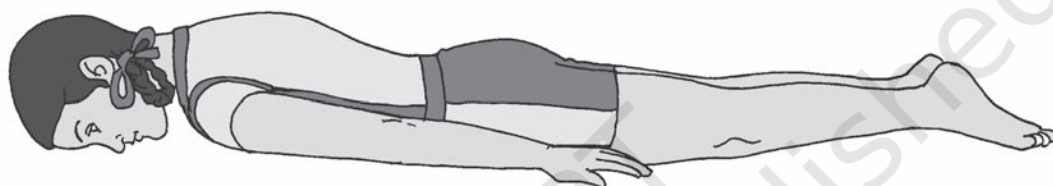

5. Maintain the position with normal breathing for few seconds.
6. To come back, slowly bring down the legs to the floor. Take out the hands from the thighs. Lie flat on the stomach, legs together, hands by the side of the thighs and palms facing downward.

**Remember the following points:**

Dos	Don'ts
<ul style="list-style-type: none"> <li>• Use the hand to balance and also to control the body weight.</li> <li>• While lifting the leg, contract the lower dorsal muscles and press the abdomen on the floor.</li> <li>• Legs should be outstretched and straight.</li> </ul>	<ul style="list-style-type: none"> <li>• Jerk and unbearable strains should be avoided.</li> <li>• Do not rush through the exercise and do not push yourself too much.</li> <li>• Do not put too much pressure on the hands.</li> </ul>

**Benefits**

- *Shalabhasana* stimulates the autonomic nervous system especially the parasympathetic system.
- It strengthens the lower back and pelvic organs.
- It gives relief in the conditions of mild sciatica, backache and non-serious slip disk.

- It is a good exercise for the legs, thighs, hips, buttocks, the lower abdomen, diaphragm and wrists.
- It improves blood circulation in the pelvic region.
- It helps to reduce excessive fat formed around the knees, the thighs, the waist and the abdomen and thereby improves physical appearance and positive body image.
- It helps to regulate the functioning of liver.
- It is beneficial to increase elasticity and flexibility of spine.

**Limitation**

- People suffering from high blood pressure, asthma and cardiac diseases, weak lungs, hernia, peptic ulcers and intestinal tuberculosis should avoid practising this *asana*.

**9.4.12 Dhanurasana (Bow Posture)**

In Sanskrit *Dhanur* means ‘bow’. This is called the bow posture because in this posture the body resembles a bow with its string attached to it. The trunk and the thighs represent the bow, whereas the hands and legs take the place of the string.

**Let us perform *Dhanurasana* by following the steps given below:**

1. Lie down in prone position.
2. Exhaling, slowly bend the legs backwards at the knees.
3. Hold the toes or ankles firmly with hands as per your capacity.
4. Inhaling, raise thighs, head and chest as high as possible. Stretch and bring the toes or ankles towards head. Look upward. Maintain the position comfortably for 5-10 seconds.
5. To come back, release the arms and keep them beside the body. Straighten the legs. Bring the legs, head, shoulders and chest slowly on the floor and relax in starting position.

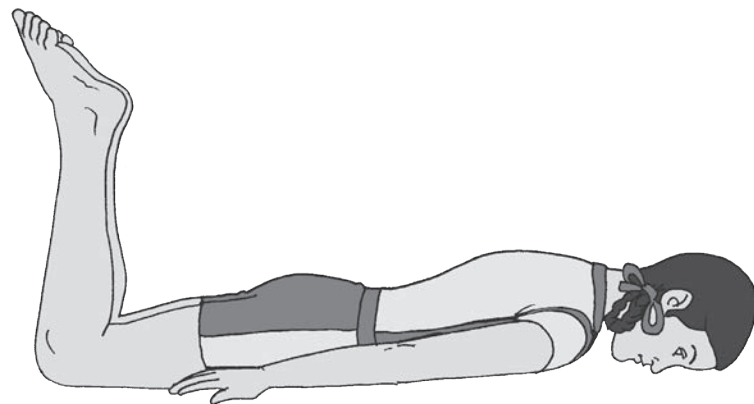
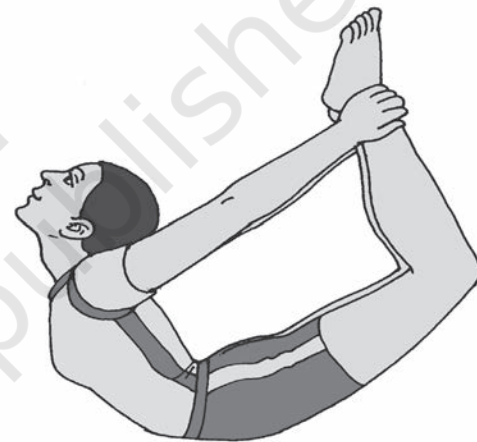

**Remember the following points:**

Dos	Don'ts
<ul style="list-style-type: none"> <li>• Balance the weight of body on lower abdominal region.</li> <li>• Arch the back, as much as possible.</li> <li>• Keep the chest close to the floor.</li> <li>• The arms should be straight.</li> </ul>	<ul style="list-style-type: none"> <li>• Do not jerk or strain, take the position slowly.</li> <li>• While assuming the posture, do not lean over to a side.</li> <li>• Do not bend or spread out the elbows, while maintaining the posture.</li> </ul>

**Benefits**

- *Dhanurasana* is a good exercise for joint of the shoulders, knees, ankles and entire backbone.
- It is beneficial for management of diabetes mellitus as it massages the liver and pancreas.
- It helps to reduce excess fat around the belly, waist and hips.
- It strengthens the ligaments, muscles and nerves in the back, arms, legs, shoulders, neck and abdomen.
- It stimulates and regulates thyroid and adrenal glands.
- It helps in reducing backache pain.
- It is good for the conditions of hunched back and drooping shoulders.

**Limitation**

- Person with high blood pressure, hernia, peptic ulcer, appendicitis, colitis slipped disc, lumber spondylitis should not practise this *asana*.

**9.4.13 Sarvangasana (Shoulder Stand Posture)**

*Sarvangasana* comprises three words: *sarva*, *anga* and *asana*. In Sanskrit, *sarva* means 'whole' and *anga* means 'parts of the body' and *asana* means 'posture'. The posture is called *Sarvangasana*, because it influences the whole body.

**Let us perform *Sarvang-asana* by following the steps given below:**

1. Lie on the back with the hands along the thighs, palms resting on the ground.
2. Pushing down on hands slowly raise both the legs up to 30°. Hold the position for few seconds.
3. Slowly, raise the legs further up to 60° and maintain the position for few seconds.
4. Raise the legs further up to 90° and maintain the position for few seconds.





5. Bend the arms at the elbow and place the hands at the hips. Now, cupping the buttocks with hands raise the buttocks. Raise legs, abdomen and chest up vertically in a straight line with the trunk. Place the palms on your back to support the back.
6. Push the chest forward so that it presses firmly against the chin. Keep the elbows close to each other.
7. Maintain the position comfortably for 5-10 seconds.
8. To come back, lower the spine very slowly along the floor. Lower the buttocks with hands supporting the back and bring the buttocks on the ground. Bring the legs up to 90° and stop there. Place the hands firmly on the ground close to the body. Lower the legs still up to 60° and 30° and then slowly on the ground and relax.

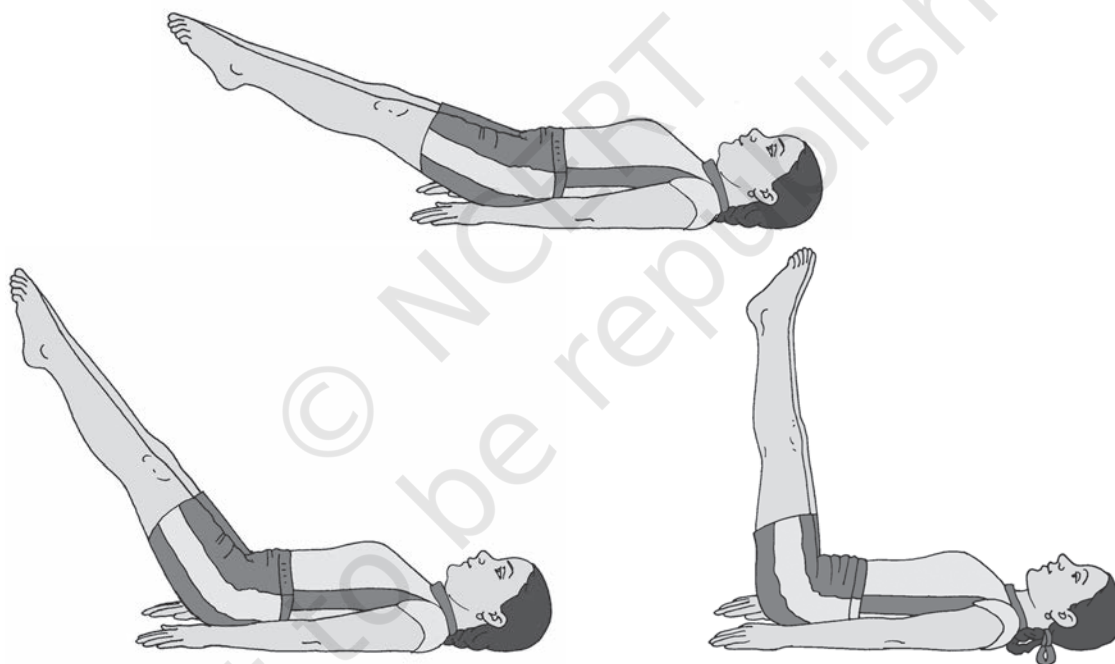

**Remember the following points:**

Dos	Don'ts
<ul style="list-style-type: none"> <li>• Movements of the legs should be very slow, stopping at different angles.</li> <li>• In the final position, keep the legs vertical in a straight line with the trunk.</li> <li>• Support the back with your hands.</li> </ul>	<ul style="list-style-type: none"> <li>• Avoid bending the legs.</li> <li>• Avoid jerky action in assuming the final position or returning from it.</li> </ul>

**Benefits**

- It regulates the thyroid function.
- It helps in increasing the circulation of blood to the brain.
- It strengthens the neck region.
- It helps in managing problems related to endocrine glands.

**Limitation**

- Those suffering from high blood pressure, epilepsy, pain in neck and lumbar region, excessive obesity and cardiovascular complaint should not practise it.

**9.4.14 Halasana**

*Hala* in Sanskrit and Hindi means 'plough'. In the final position of this *asana*, the body resembles the shape of a plough. As plough makes the hard ground soft, in this *asana* the veins are stretched which reduces the stiffness of the body.

**Let us perform *Halasana* by following the steps given below:**

1. Lie in supine position, legs together and arms beside the body.
2. Keeping the knees straight, raise the legs up to 30°.
3. Raise the legs further up to 60°.
4. Raise the legs still further up to 90°, keeping them vertical and straight.

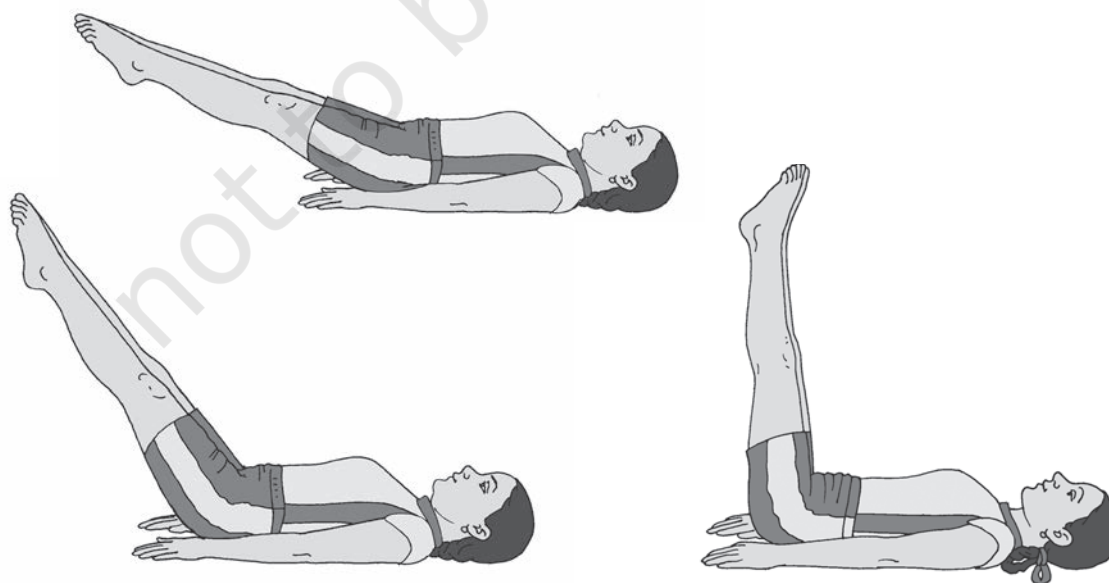

5. Pressing the arms raise the trunk by lowering the legs over the head, the toes touching the ground. Push the legs a little beyond the head.
6. Keep the arm straight on floor. Maintain the position for 5-10 seconds.
7. To come back, remove the arms, slowly lower the back and buttocks to the ground, bring the legs to 90° position. Lower the legs to starting position.

**Remember the following points:**

Dos	Don'ts
<ul style="list-style-type: none"> <li>• Go to the different stages slowly and retain them for some time.</li> <li>• Give the support of the hands to the back while raising the trunk.</li> <li>• Keep the knees straight through all the stages of the <i>asana</i>.</li> <li>• Balance weight on hands and shoulders.</li> </ul>	<ul style="list-style-type: none"> <li>• Avoid giving any type of jerk to the body.</li> <li>• Do not withdraw the support of the hand at the back until the legs touch the ground.</li> <li>• Do not force the legs to touch the ground, if it is difficult.</li> </ul>

**Benefits**

- It gives good exercise to the thyroid gland/parathyroid gland.
- It gives a good stretch to the spinal column and back deep muscles, making the spine strong and healthy.
- It helps in increasing the height of children.
- It alleviates problem of dyspepsia and constipation is removed.

**Limitation**

- Practice of this asana should be avoided in case of stiffness in spine, cervical spondylities, hernia, high blood pressure and slipped disc.

**9.4.15 Shavasana (Corpse Posture)**

In Sanskrit, *Shava* means a 'dead body'. In this posture the body resembles like a dead body, hence, this *asana* is called *Shavasana*. As the name suggests, this *asana* takes the person away from tension; reduces stress and is relaxing to the body and the mind.

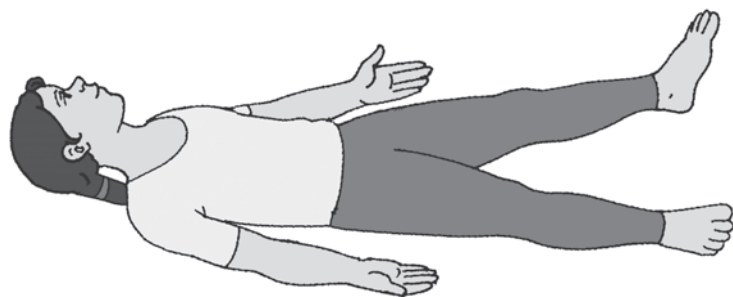

**Let us perform *Shavasana* by following the steps given below:**

1. Lie flat in supine position.
2. Keep the legs straight with feet at 8-12 inches apart. Keep heels inside and toes outside.
3. Keep the palms facing upward slightly away from the body with fingers in a semi-flexed position.
4. Take deep breath and simultaneously close the eyes. Feel complete relaxation in your body. Try to relax all parts of your body.
5. Breathe normally and concentrate on the flow of breath.
6. To come back, open your eyes and come to the starting position.

**Remember the following points:**

Dos	Don'ts
<ul style="list-style-type: none"> <li>• Withdraw attention from external surroundings.</li> <li>• All parts of body should be relaxed.</li> <li>• Try to be aware of the internal happenings.</li> </ul>	<ul style="list-style-type: none"> <li>• Do not tense the muscles of body.</li> <li>• Try not to sleep.</li> </ul>

**Benefits**

- It removes stress and tension.
- It is useful to reduce high blood pressure.
- It relaxes the body and mind.
- It removes fatigue from the body.
- It is beneficial in the cases of insomnia as it helps to induce sleep.

**Limitation**

- Do not practise if suffering from low blood pressure.

## 9.5 KRIYA

### 9.5.1 *Kapalabhati* (Frontal Brain Cleansing)

*Kapalabhati* is considered a *Kriya* (cleansing practice) which cleanses the frontal brain. In Sanskrit, *Kapala* means 'skull' and *bhati* means 'shine'. *Kapalabhati* helps to improve the functions of the organs located in the skull.

**Let us perform *Kapalabhati* by following the steps given below:**

1. Sit straight in any meditative pose like *Padmasana* or *Vajrasana*.
2. Take deep breath through the nostrils.



- Exhale forcefully in such a way that the lower abdomen is contracted to expel out the air. Inhale spontaneously and passively without making any efforts. Do not make effort to inhale. Air will enter the body through the passive inhalation. This is one stroke of Kapalabhati. Begin with 20 strokes at a time. This is one round. One can practise one to three rounds in a practical session. Gradually increase the strokes in one round.

**Remember the following points:**

Dos	Don'ts
<ul style="list-style-type: none"> <li>Inhalation should be passive and short, while exhalation should be forceful.</li> <li>Kapalabhati should be practised after asana but before meditation.</li> </ul>	<ul style="list-style-type: none"> <li>Do not move the chest or shoulders during exhalation.</li> <li>Do not contract or distort the face.</li> </ul>

**Benefits**

- It stimulates the nerves in the abdominal region, tones up the abdominal muscles and improves digestion.
- Kapalabhati* expels more carbon-dioxide and other waste gases from the lungs than the normal breathing.
- It improves heart and lungs capacity and therefore good for bronchial/asthma.
- It improves blood circulation throughout the body.
- It energises the body and removes lethargy.

**Limitation**

- Those suffering from cardio-vascular problems, high blood pressure, hernia, vertigo and gastric ulcer complaints, should avoid practising *kapalabhati*.

**9.5.2 Agnisara**

It is considered as a *Kriya* in yogic practices. The meaning of *Agnisara* is to increase the gastric fire. In Sanskrit *agni* means 'fire' and *sara* means 'essence'. This *kriya* regulates the essence of fire which is supposed to be located in the navel region. This practice regulates the functioning of abdominal organs.

**Let us perform Agnisara by following the steps given below:**

- Stand erect with the feet apart from each other.
- Keep the hands on thighs above the knee. Exhale completely.
- Bend the knees and the upper part forward.

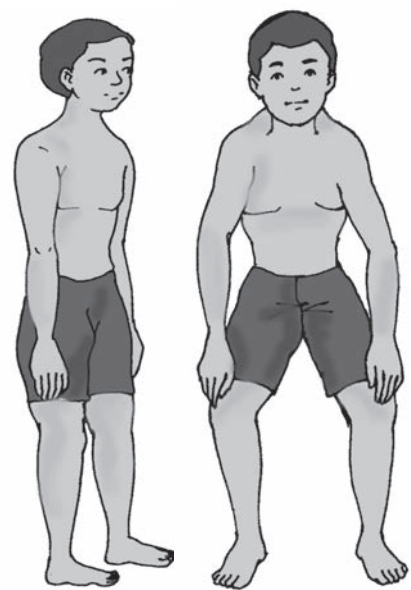



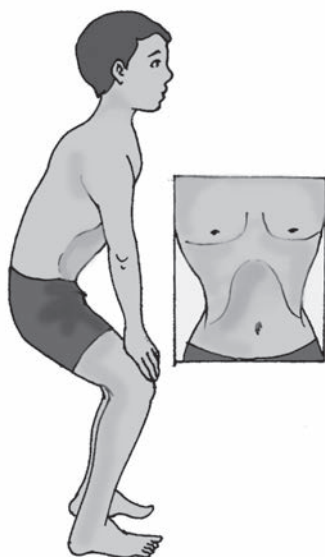

- Contract and expand the abdominal muscles rapidly for as long as comfortable while retaining the breath out side.
- Then slowly breathe in. Repeat the practice 2-3 times.

**Remember the following points:**

Dos	Don'ts
<ul style="list-style-type: none"> <li>It is advisable to practise it on an empty stomach.</li> <li>Do practise for two or three times.</li> </ul>	<ul style="list-style-type: none"> <li>Avoid slightest inhalatory effort.</li> <li>Do not practise it after meals.</li> </ul>

**Benefits**

- It strengthens the abdominal muscles and nerves.
- It improves the gastric fire and stimulates appetite.
- It alleviates constipation and sluggishness of liver.
- It alleviates dullness and depression.

**Limitation**

- Person suffering from high blood pressure, heart disease, peptic ulcers or chronic diarrhoea should not perform this *kriya*.

## 9.6 PRANAYAMA

*Prana* refers to the 'universal life force' and *ayama* means to 'regulate'. *Prana* is the vital energy without which the body would not survive. *Pranayama* relates to breathing techniques which help to increase breathing capacity. Some common *pranayamas* include *anuloma-viloma*, *bhastrika*, *ujjayi*, *sheetali*, etc.

### 9.6.1 Anuloma-viloma Pranayama (Alternate Nostril Breathing)



The *Anuloma* means 'towards' and *Viloma* means 'reverse'. It is called *Anuloma-viloma* because alternate nostrils are used for each inhalation and exhalation. One inhales through the left nostril and then exhales through the right nostril, then the order is reversed by inhaling through the right nostril, and exhaling through the left nostril. This *pranayama* is called *Nadi-shodhana pranayama* also, if it is performed with *kumbhaka* (holding the breath).

**Let us perform *Anuloma-viloma* by following the steps given below:**

- Sit in the position of *Padmasana* or in any other comfortable meditative posture.

2. Keep the body erect and place the hands on the respective knees.
3. Raise the right hand and place the right thumb on the right nostril and close it.
4. Inhale slowly through the left nostril.
5. Close the left nostril by the ring finger and the little finger and exhale slowly through the right nostril.
6. Again inhale through the right nostril.
7. Close the right nostril with thumb and exhale through the left nostril. This is one round of *Anuloma-viloma*.
8. Repeat it 10 times.

**Remember the following points:**

Dos	Don'ts
<ul style="list-style-type: none"> <li>• Inhale the air slowly without bulging the abdomen.</li> <li>• Keep the ratio of 1:1 or 1:2 between the inhalation and the exhalation.</li> </ul>	<ul style="list-style-type: none"> <li>• Avoid producing sound from the nose.</li> <li>• Do not press hard on the nostrils.</li> <li>• Avoid retaining breath (<i>kumbhaka</i>) in the beginning.</li> </ul>

**Benefits**

- It calms down the mind and improves concentration.
- It improves functioning of all cells of the body by providing them sufficient oxygenated blood.
- It purifies the blood.
- It improves blood supply to brain.
- It helps to regulate blood pressure.
- It helps in managing stress by reducing anxiety.
- It is beneficial in many diseases such as asthma, high or low blood pressure, insomnia, chronic pain, endocrine imbalances, heart-problems, hyperactivity, etc.

**Limitation**

- In the beginning, retention of breath should be avoided.

**9.6.2 Bhastrika Pranayama**

The word *Bhastrika* has been taken from a Sanskrit word '*bhastra*' which means a pair of 'bellows'. In this *pranayama*, the action of a *bhastra* or bellows are imitated. In this pranayama, inhalation and exhalation are done forcefully in rapid succession. Just as a blacksmith blows in and out the bellows forcefully in rapid succession, dilating and contracting it, similarly breath is taken in and out by dilating and contracting the stomach in forced and rapid succession.

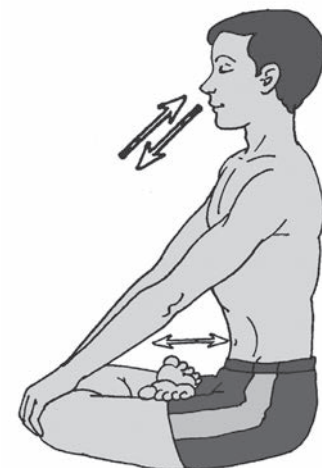

**Let us perform *Bhastrika Pranayama* by following the steps given below:**

1. Sit in *Padmasana*, *Ardhapadmasana* or in any other meditative posture. Keep the body erect.
2. Slowly inhale through the nostrils.
3. Then exhale quickly and forcefully through the nostrils.
4. Immediately inhale with force.
5. Continue this forceful rapid exhalation and inhalation counting up to ten breaths.
6. At the end of the tenth breath, the final exhalation is followed by a deep inhalation and slow exhalation. This is one round of *Bhastrika pranayama*.
7. Take few normal breaths after this round before starting another round.
8. Complete three rounds of *Bhastrika pranayama*.
9. There may be variations in the technique of *Bhastrika pranayama*.

**Remember the following points:**

Dos	Don'ts
<ul style="list-style-type: none"> <li>• Sit straight and open the chest for proper strokes.</li> <li>• Lungs, diaphragm and stomach should move with each inhalation and exhalation.</li> <li>• <i>Bhastrika pranayama</i> should be performed after <i>asana</i> and <i>nadishodhana pranayama</i>.</li> </ul>	<ul style="list-style-type: none"> <li>• Do not go beyond the capacity.</li> <li>• Chest and shoulders should not move.</li> <li>• Do not practise it in extremely hot conditions.</li> </ul>

**Benefits**

- It increases gastric fire and improves appetite.
- It destroys phlegm.
- It is beneficial in case of asthma.

**Limitation**

- *Bhastrika pranayama* should not be practised during ear infection. Person suffering from heart problems, high blood pressure, vertigo, stomach ulcers should not practise this *pranayama*.

## 9.7 BANDHA

### 9.7.1 Uddiyana Bandha

In Sanskrit, *uddiyana* means ‘raising up’ and *bandha* means ‘contraction’ of any part of the body. This may be called *uddiyana* because it raises the diaphragm up. In this *bandha*, the diaphragm is made to fly up from its original position and held very high in the thoracic cavity.

This *bandha* exercises the diaphragm and the ribs. It can be practised either in sitting or in standing position.

**Let us perform Uddiyana Bandha by following the steps given below:**

1. Sit in *Padmasana*, *Vajrasana* or *Sukhasana*. Keep the hands on knees.
2. Exhale through the mouth emptying the lungs as much as possible. Hold the breath outside and press down the knees with palms.
3. Form a pit in the abdomen. For making the pit, contract the abdominal muscles inward towards the spine and upwards (abdominal lock). Hold the breath outside with abdominal lock for as long as comfortable.
4. To come back, gradually release the abdominal lock, come slowly to the starting position and start inhaling slowly.

(Repeat it 3-4 times.)

**Remember the following points:**

Dos	Don'ts
<ul style="list-style-type: none"> <li>• Have the deepest possible exhalation.</li> <li>• Keep the front abdominal muscles completely relaxed and expand the chest.</li> <li>• Practise <i>Uddiyana</i> only on an empty stomach.</li> <li>• Perform <i>uddiyana bandha</i> with external breath retention only.</li> </ul>	<ul style="list-style-type: none"> <li>• Avoid allowing the air to flow into the lungs during the practice.</li> <li>• A beginner should not make more than three attempts a day.</li> </ul>

#### Benefits

- It increases the respiratory efficiency.
- It Improves blood circulation in the thoracic and abdominal region.
- It tones up the abdominal muscles.
- It is beneficial in the conditions of constipation, indigestion and diabetes mellitus.



### Limitation

- Person suffering from hernia, high blood pressure, heart disease, intestinal ulcers should not practise this.

## 9.8 DHYANA (MEDITATION)

Meditation is a yogic practice by which mind becomes still and relaxed. We all know that our mind always remains active and never takes rest. All kinds of thoughts and emotions negatively affect it and as a result minds becomes disturbed. In order to pacify and relax the mind, it is to be stilled. This can be done by taking the mind away from the external things.



For pacifying and relaxing the mind, meditation is a very effective practice. It relaxes body and mind both and refuels them with energy. Several researches indicate that meditation improves the functioning of brain.

There are several techniques of meditation. They vary in the methodology but the goal of all techniques is same, i.e., reaching an inner calm and a higher level of awareness. All techniques of meditation involve focussing on a single point which could be breath, a *mantra*, a word or an object. In the beginning, focussing of the mind is difficult; therefore a beginner can start meditating for a few minutes only and later on can increase its duration.

**Let us practice meditation by following the steps given below:**

1. Sit in *Padmasana*, *Sukhasana* or in any meditative comfortable posture. Place your hands in *Jnana mudra* on your respective knees. Keep your spine erect. Close your eyes gently.
2. Breathe normally.



3. Focus your attention on the breath. Go inside yourself and observe your breathing. Concentrate on inhalation and exhalation. During the practice, your mind may wander here and there. Try to concentrate on your breath only. Breathe normally.
4. Now you can focus on the space between the eyebrows with closed eyes. Remain in this position for five minutes.
5. To come back, bring your consciousness very slowly back to the external surroundings.
6. Cup the eyes with the hands and blink the eyes for a few seconds so that sudden exposure to light does not irritate them. Slowly open your eyes and remove the hands. Slowly externalise yourself.

Meditation can be performed in different forms. For example, instead of breath, one may focus on sound also. For this, slowly produce the sound, keep on reducing its volume till it comes to a barely audible note. Then stay calm and concentrate on the tip of the nose or the space between the eyebrows with closed eyes.

### Benefits

- It gives deeper relaxation.
- It lowers heart rate and blood pressure.
- It slows respiratory rate.
- It helps to reduce stress.
- It helps in managing emotions.

### Introspection

In addition to above yogic practices, you can practise introspection for personality development. Introspection means inner inspection or self observation. It also means looking within. Introspection is an important method by which a person becomes aware about the self. This practice makes us aware about our strengths and weaknesses. Introspection can be done anytime.

You can practise introspection before going to bed.

**Let us practise introspection by following the steps given below:**

1. Sit in *Padmasana* or any other comfortable meditation pose.
2. Close your eyes.
3. Observe your breaths. Focus your mind on your breath only. Many unwanted thoughts may come to your mind and disturb you but try to focus on breath only.

4. Now think about the day that has just passed. Think on the following:
  - How did you spend your day?
  - Did you waste your time on unnecessary activities?
  - How did you behave with others?
  - What kind of thoughts you had during the day?
5. Analyse your behaviour. If you find mistakes in your behaviour then make a resolve not to repeat them again.
6. Make a plan for the next day. Fix your targets for the next day and plan accordingly to achieve them.
7. Now, stop thinking and focus on your breath. Now gently open your eyes and relax.

## ASSESSMENT

### Answer the following questions

1. Mention various dimensions of personality.
2. Which yogic practice is useful for developing physical dimension of personality?
3. Which practice can help you develop emotional control?
4. Write two advantages of *asana*?
5. What are benefits of *Kapalabhati*?
6. Which practices would you like to perform to develop interpersonal relationships?
7. What are the benefits of *Bhastrika*?
8. Write the names of *asana* which derive their name from living and non-living objects.
9. Mention the importance of introspection.
10. Write the technique of meditation.
11. Write a short note on *pranayama*.
12. Which yogic practices are related to the behaviour and need to be adopted irrespective of time and place.

### PROJECT

- Prepare a chart of five *asana* which have been named after animals.
- Collect stories related to the principles of *Yama* and *niyama* and prepare a folder.
- Prepare a chart on the changes you have experienced in various dimensions of personality.

# Waste Management

10

## 10.1 INTRODUCTION

We all observe how waste is generated in our homes and neighbourhood and how it is disposed of. The disposal of waste has been done in a haphazard manner since ages, be it in villages, towns or cities. But today waste generation and disposal has become a matter of concern owing to the enormous increase in population, the changes in our lifestyles and consumption patterns, huge expansion of industries, transport, communication and commercial infrastructures and unrestrained use of modern technology. In fact, waste management has emerged as a serious challenge having major implications not only for human health and social life but also for the environment.

It is in this context that this chapter deals with different dimensions of waste management. The focus in this chapter, is on solid waste disposal.

## 10.2 SOLID WASTE

What do we mean by solid waste? Almost everything that we use degenerates and loses its utility over a period of time. Many things become unusable after we use them only once. We then throw them away. Everything that we discard after it loses its usability is known as solid waste or garbage. There are different sources from where solid waste or garbage is generated everyday from individual households (domestic waste), and from industries and commercial establishments. However, all such wastes are not uniform in nature. Broadly speaking, solid wastes can be divided into two distinct categories **biodegradable** and **non-biodegradable** waste.



13149CH10

### ACTIVITY 10.1

Bring some waste materials from home. This can be kitchen waste (for example, vegetable peels, used tea leaves, some food leftovers) and discarded articles of use, such as empty jars of plastic or/and glass, used paper, torn cloth etc.

- Bury those items in the school garden, or in a bucket or flower pot, and cover them with sufficient soil.
- Leave the items buried for about three weeks after which take those items out for review.
- You will find that certain materials have changed their form, i.e. they have decayed, decomposed or are in the process of decomposition. On the other hand, some other materials are almost in the same form.
- Those materials that have decayed or decomposed are biodegradable materials, whereas, those in which there was no change are non-biodegradable materials.
- Think about the reasons of this variation and write.

**Box 10.1**

In your history textbook you must have studied how archaeologists record the lives of ancient societies through the material remains left behind by them. These materials give us a glimpse of how people lived, what they ate and other aspects of their lives. Why do you think these materials have still retained their form?

**Box 10.2**

As a reference, you can look into the Science textbook (Class VII), for the decomposition period of both biodegradable and non-biodegradable materials.

**10.2.1 Biodegradable and Non-biodegradable Waste**

Let us understand how biodegradable wastes are different from non-biodegradable wastes by conducting the following activity.

We define biodegradable materials as those substances made of organic matter, such as plant and animal matter, that can be easily broken down by nature. For example, vegetable peels and other kitchen waste, vegetables, fruits, tea leaves, paper, wood, etc.

Non-biodegradable materials are those materials, which cannot be broken down easily, and retain their form for a long period of time. For example, metals, tin, glass, plastics etc.

**10.3 SOLID WASTE DISPOSAL**

The garbage that we generate every day has not only increased in volume phenomenally, but has also changed its composition due to changes in our lifestyles and consumption patterns. For instance, there is now an increasing use of non-biodegradable materials such as plastics, metals and glass, specifically in urban areas.

Technological advancement has further brought in an increasing use of electronic items and gadgets. These are useful for us, but when discarded (known as E-Waste) they can be harmful to the environment and human health, particularly for the workers associated with this occupation.

In addition, we seem to have lost our aesthetic and civic sense, and carelessly litter garbage around on the roads, in the market-place, in open drains, ponds, rivers, seas, and so on. In fact, we keep throwing a lot of garbage everyday. Have you ever thought what will happen if the garbage is not removed from our homes and surroundings? Where does this garbage ultimately go and what is done with it? If proper measures for disposal and sanitation are not followed, how will garbage affect our environment and health?

**10.3.1 Consequences of Solid Waste Disposal**

In the cities and towns, collection of garbage is the responsibility of the respective municipalities. The garbage then goes through a process of segregation, treatment and final disposal in the landfills. This process of segregation in our country is still done manually by rag pickers. (See Fig. 10.1). In this process, materials that can be recycled are separated, while toxic wastes are sorted out and kept separately. This process of segregation ensures that the amount of solid waste, which is ultimately disposed of in the landfills, is reduced substantially.



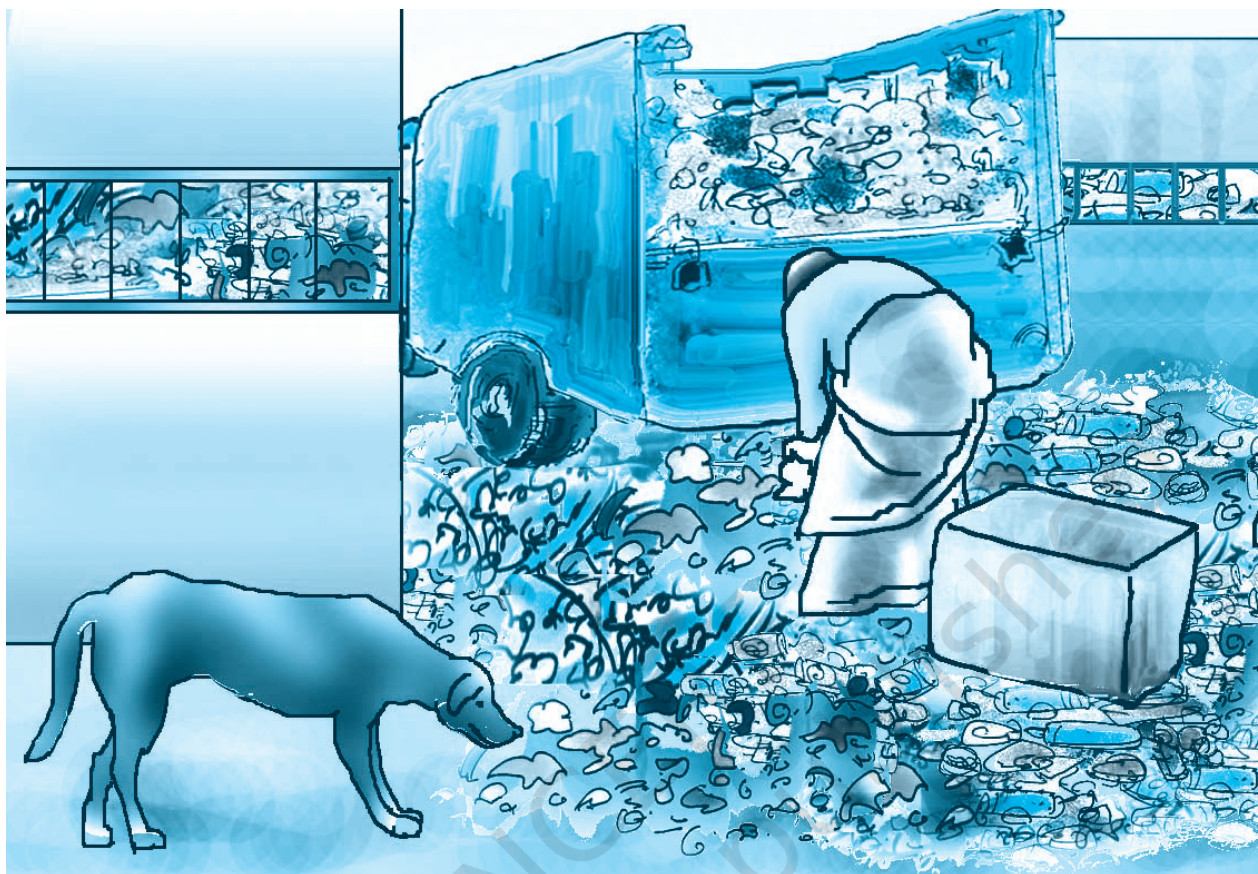

Fig. 10.1 : A rag picker segregating materials from garbage dump

However, with the enormous volume of waste that is being generated now-a-days, the concerned authorities are finding it difficult to deal with this problem. Most often we find that all sorts of solid wastes are dumped together in the landfills, which in many places, have already overreached its accumulation level. Moreover, groundwater in the immediate vicinity of such landfill sites is prone to contamination through continuous contact with the deposited waste. (Details of the structure of landfills have already been given in the Science textbook of Class VI).

In most of the rural areas, people have to deal with the disposal of household wastes themselves. A common method is the burning of solid wastes. This may be a convenient method, but is not conducive either to the environment or to our health, as it causes air pollution. Many of the villages do practise composting which is the desirable method.

### 10.3.2 Effects of Undisposed or Unattended Garbage

Open and unattended garbage is a common sight in the market, streets or in the vicinity of our homes. Most often, it



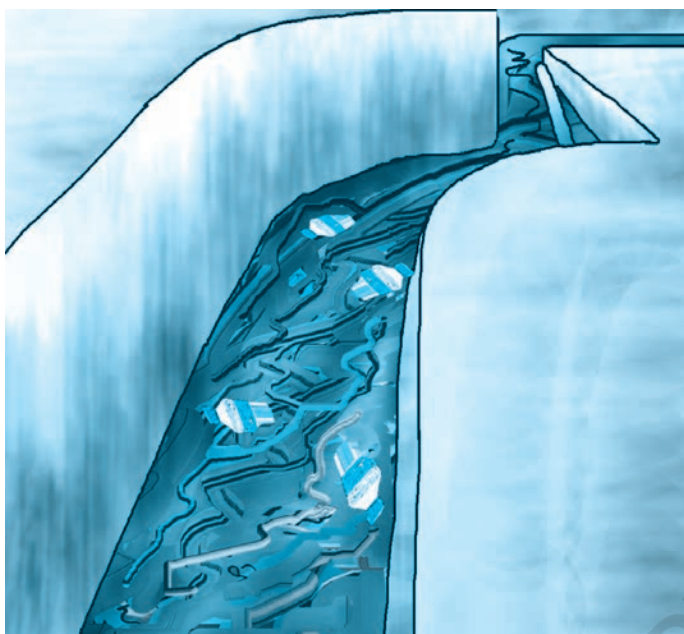

Fig. 10.2 : Discarded plastic bottles in an open drain

emits such a foul smell that we have to cover our noses with a cloth. Have you ever stopped to think how unattended garbage can affect our health and our environment? If you observe carefully, you will notice that when garbage is allowed to collect in the open for a long time, it attracts flies, cockroaches and other insects. It also attracts rats and stray dogs. In fact, moist or fermenting garbage, particularly when organic waste such as kitchen waste is thrown, becomes a perfect breeding place for flies. When we eat the food, which has been contaminated by these flies, we are likely to fall ill. Water and food borne diseases such as dysentery, cholera and gastroenteritis are some of the diseases that can be transmitted by flies. Moreover, since accumulated garbage emits foul smell, it also causes air pollution.

**Table 10.1 Types of waste**

Toxic Waste	E-Waste	Hospital Waste or Soiled Waste
Toxic waste causes serious problem to our health and to the environment. Examples: dried paint, old bulbs, old batteries.	E-waste consists of dismantled parts of computers, electronic appliances, mobile phones, TV, floppy discs, pen drives. In India E-wastes are dumped into unsafe and unauthorised dumping yards where they are dismantled manually and unscientifically, causing great environmental and health risks as they contain dangerous contaminants.	Consists of various components containing infected human tissues or body fluids and are called bio-hazardous. The needles, surgical knives, and other surgical instruments called 'sharps' have to be disposed of carefully, but many a time we find this does not happen. Being pricked with infected needles can transmit diseases like HIV, Hepatitis B and C.

Indiscriminate use and disposal of plastic can clog the drains (Fig 10.2). Moreover, during the rainy season, the waste may flow along with the rainwater to nearby rivers and other

## ACTIVITY 10.2

You may collect information on the following points.

- What method of garbage disposal is practised in your community?
- Who collects the garbage from your home?
- Do you ever lift the garbage at the community site?
- How far is this site from your home?
- Have you ever observed flies, mosquitoes, insects and stray animals around the garbage disposal site?
- What are the methods utilised by the community for final disposal of garbage?
- On the basis of the information collected, answer the following questions.
- Do you think the method of garbage disposal in your community is appropriate?
- If yes, explain how?
- If not, what would you suggest to ensure sanitary conditions for garbage disposal from your community?

surface water bodies, thereby, polluting them and affecting aquatic life. When we drink the polluted and untreated water, we succumb to water borne diseases.

Carelessly disposed off hospital of waste and e-waste may also pose health problems. This is also called hazardous waste.

## 10.4 WASTE MANAGEMENT AND SEGREGATION

You must have heard the slogan, “Reuse, Recycle, Reduce and Refuse.” This slogan is associated with the practice of waste segregation and management. Waste segregation and management is a process by which we categorise waste products and garbage, on the basis of what we can reduce, reuse and recycle. We have discussed earlier that the volume of solid waste that is generated by us, has reached such an alarming proportion, that government alone cannot deal with it. We also have to be aware of the environmental and health hazards associated with it. As it is a problem that has emanated from us, we must make efforts to resolve it. By practising waste segregation and management we can reduce the volume of solid waste.

### ACTIVITY 10.3

- Make a record of all the items that were disposed of from your home last week.
- Make a rough estimate of each item of solid waste. This estimate can be presented in the Table 10.2.
- Quantity of waste generated at home in a month.
- Based on your estimates, give some suggestions on how you can reduce the volume of kitchen waste to almost zero.
- Are there any items in your waste, which can be reused or recycled? Make a list of these items.
- Make a list of items that cannot be reused or recycled. If there are hazardous wastes in these items how will you dispose them of?
- You may compare your observations and suggestions with your classmates.



Fig. 10.3 : Children playing with waste material

Through this activity you will be surprised to find that many of the items that have been discarded by you, still have utility. On the other hand, there are certain wastes, such as wet waste (kitchen waste), which can be reduced to almost 'zero waste'. Let us now discuss how we can reduce the volume of solid waste and garbage, by practising waste management and segregation through the principles of "reuse, recycle, reduce and refuse."

**Table 10.2**

Items	Quantity (%) of total home waste
Kitchen waste	50
Glass	
Paper	
Plastics	
Old cloth	
Metals	
Old medicines	
Others	



### 10.4.1 Practising Waste Management and Segregation

#### 1. Segregation at Source

The first and most important principle for waste management is segregation at source. Segregation of garbage at source should be practised at home, at school, office and markets. Garbage can be disposed of in separate bins (Fig 10.4). Blue bins may be used for non-biodegradable and green bins for biodegradable waste.

At home, you may segregate waste into the following categories.

- (a) Wet waste, (b) dry waste, (c) hazardous waste.



Fig. 10.4 : Blue and Green Bins

In the cities we find these bins in some places, where people can dispose of biodegradable and non-biodegradable garbage separately. Where do you think we should dispose of hazardous waste? Should there be a separate bin for it? Why?

#### 2. Reduce, Reuse, Recycle and Refuse

We should segregate waste products with a view to **reduce, reuse, recycle and refuse**. In Activity 10.3 you have seen that there are different types of waste that are generated in our homes. For most of us, kitchen wastes (fruit peels, vegetables, leftover food, tea leaves) forms a large percentage of the total waste at home. Composting is a common method to **reduce** the volume of kitchen waste to 'zero waste.' It is also an effective way through which kitchen waste can be recycled back into nature.

There are certain items in our garbage that can be reused. Reusing discarded items means that instead of dumping them and increasing the load of waste, we can **reuse** these items. Some examples are given here.

- Items such as plastic containers and pickle bottles can be reused to store other things.
- We can reuse wrapping papers, cardboard boxes and chocolate boxes.
- We can give away old clothes to the needy.
- It is better to use cloth bags instead of plastic bags for shopping.
- Buy products which can be **reused** such as rechargeable batteries.

### Box 10.3

#### How to Prepare a Compost Pit

- Pits can be dug in the house compound. In case we don't have space at home, we can use flower pots at home, or we can put them at the community sites collectively.
- Kitchen waste can be disposed of in the pits/flower pots/community sites and covered with soil everyday.
- When the pit is filled, it can be completely covered with soil and closed for a period of approximately five to six months. After that period the waste will decompose into brown mass called compost due to bacterial action and can be used as manure for plants.

Often you may have come across persons (the *Kabariwalas*) who visit our home, and to whom we sell old newspapers, magazines, bottles, tins, etc. Maybe, you have never thought where these products go, and what happens to them. These products are utilised as raw materials for manufacturing other products. In other words, these products are **recycled**. This is actually an important effort, as in this process, we not only reduce the load of garbage, but also conserve natural resources. Some of the common items that can be recycled are



Fig. 10.5 Compost Pit prepared by Bethany Society, Shillong, Meghalaya



glass, metals, paper, plastics, cardboard, batteries, cans made of steel and aluminium, rubber, wooden furniture.

While segregating wastes, you will find that there are also a large number of items that cannot be reused or recycled. In Activity 10.3 you have made a list of these items. You must have also noticed that some of these items are non-biodegradable in nature. So what we can do is to **reduce** unnecessary consumption and purchases. We may also **refuse** to accept items that are damaging to the environment and human health. Some examples are given below.

- Look for products that do not have elaborate packing.
- Use things judiciously.
- Do not waste food.
- Refuse offer of plastic bags.
- Develop eco-friendly habits.

You must have now understood the importance and necessity of practising waste segregation and management. Each of us should develop awareness towards this issue. By practising waste segregation and management we will not only safeguard ourselves from numerous health hazards, but also save our environment from pollution.

#### ACTIVITY 10.4

Visit a recycling unit along with your classmates and record the following observations.

- (a) What are the items of solid waste that are brought to the recycling unit?
- (b) Who brings these materials?
- (c) What is the sanitary condition of the godown where solid wastes to be recycled are kept?
- (d) Are any safety measures adopted for the workers involved in the recycling unit?
- (e) What are the products made from recycled material? Can you suggest any other products that could have been made?
- (f) Is there any impact of the recycling process on the environment and to human health?

#### Box 10.4

Did you know?

- For every tonne of paper that is recycled, about 2 trees are saved.
- Our newspapers are printed on recycled paper.

#### Box 10.5

We should also cultivate the habit of practising the 4 R's of waste management, i.e. Reuse, Reduce, Recycle and Refuse in our day-to-day life.



## ASSESSMENT

### Answer the following questions

1. Why is it necessary to segregate our garbage at source?
2. List at least four environmental friendly practices that can help to reduce, reuse and recycle waste or garbage.
3. What are the health risks faced by rag pickers? Suggest two measures for their safety.
4. Toxic waste, hospital waste and soiled waste should be disposed of with great care. Explain why?
5. Mention some of the health hazards associated with open garbage dumps.
6. What is the difference between biodegradable and non-biodegradable waste? How does non-biodegradable material affect our environment?
7. Suggest some ways of minimising the use of plastics in our daily life. What are the health hazards associated with plastic?
8. Which of these items cannot be recycled?
  - (a) Jars
  - (b) Bottles
  - (c) Bulbs
  - (d) Paper
9. Composting is an appropriate method for dealing with
  - (a) commercial waste
  - (b) domestic waste
  - (c) organic waste
  - (d) industrial waste
10. Which of these is not a biodegradable waste?
  - (a) Vegetable peel
  - (b) Wool
  - (c) Fruits
  - (d) Tin

# Diet for Healthy Living

11

## 11.1 INTRODUCTION

Food is our basic need. It nourishes our body and maintains our health. It gives us energy that is required for every action of ours including our participation in games and sports. The various food items that we consume constitute our diet. Diet may be defined as the total amount of different variety of food items consumed by a person during a day.



13149CH11

### ACTIVITY 11.1

Recall yourself and also ask your friends about the food items consumed by you and your friends yesterday. Based on the information, try to do the following.

- List the number servings of each of the following consumed by you and your friends yesterday.

Fruits	Vegetables	Pulses	Breads/ chapatis/ rice	Milk/milk products	Non-veg.

- Do you think the amount, variety and quality of food taken by you and your friends is adequate to meet the nutritional requirements? Let us discuss about a healthy diet.

A healthy diet should consist of simple, natural and/or well-cooked foods which promote health and protect us from diseases. It should keep our organ systems well functioning. The diet that we consume is decided by our socio-cultural norms, life style pattern and the type of activities we are engaged in. There is a delicate relationship amongst what we eat, how much we eat and what will happen to our health if we overeat or do not eat properly. In the present chapter, we shall discuss important dimensions of diet for healthy living, which include nutrition, nutrients, food groups, balanced diet, special dietary requirements, malnutrition and eating disorders.

## 11.2 DIETARY REQUIREMENTS OF HUMAN BODY

Our diet contains many food items which are obtained from different sources. The food may be obtained from animal or vegetable sources. We already know that food comprises

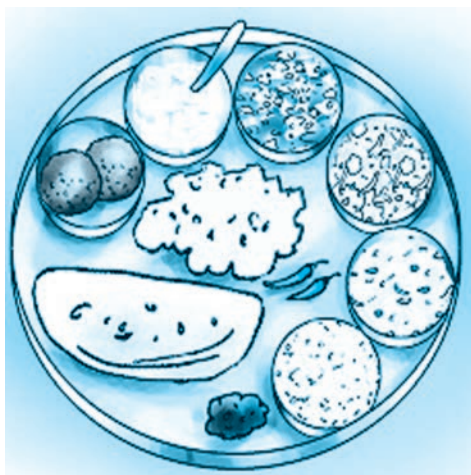

Fig 11.1 : A Vegetarian Thali

constituents like proteins, carbohydrates, fats and supplementary substances such as minerals, vitamins and water that are vital for life. These constituents are known as nutrients. For proper functioning of our body we need to consume body building foods (e.g. milk, meat, poultry, fish, eggs, pulses, groundnuts); energy giving foods (e.g. cereals, sugar, roots, fats and oils); and protective foods (e.g. vegetables, fruits).

### 11.2.1 Nutrients

The food we consume breaks down to simpler products before it is absorbed and utilised by the body. These simpler substances are called nutrients. Our body utilises nutrients for building and repairing, obtaining energy and for protection from diseases. What is nutrition? The term nutrition is related to our food intake and dietary patterns and utilisation of protein, carbohydrate, fat, vitamins and minerals to maintain our health. Most of the natural food items contain more than one nutrient. Let us understand various nutrients contained in different food items.

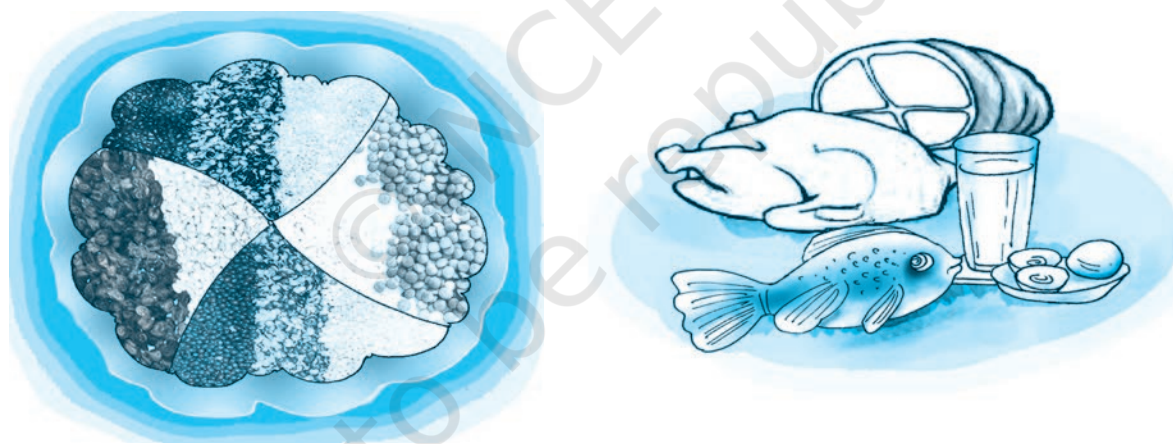

Fig 11.2 : Protein rich food items

### ACTIVITY 11.2

Find out from your parents/grandparents, the locally available fruits and their value to the health of the body.

#### 11.2.1.1 Proteins

Proteins are called building blocks of our body. About 20 per cent of our body weight comes from proteins. Proteins are essential for growth and repair of muscle and other body tissues. Proteins are made of amino acids that contain the elements carbon, hydrogen, oxygen and nitrogen. We obtain proteins from animal as well as vegetable sources. Proteins of animal origin are found in milk, eggs, cheese, fish and meat. Proteins from these sources contain all the essential amino acids (EAA) in adequate amounts. Vegetable proteins are found



in pulses (legumes), cereals, beans, nuts, oilseeds, etc. Those who take vegetarian food need to consume more and a wide variety of these foods to meet their protein needs.

#### 11.2.1.2 Carbohydrates

Carbohydrates are the main source of energy for our body. There are three major categories of carbohydrates, viz. starch, sugar and cellulose. Our body breaks down sugar and starch into glucose to provide energy. Cellulose does not have any nutritive value per se, but is a major contributor of dietary fibres. Excess carbohydrates are converted into fat by the liver and stored in the adipose tissues in our body.

Carbohydrates are of two types – simple and complex. Simple carbohydrates are quick energy foods, e.g. sugar. Sources of simple carbohydrates are natural fruits, milk and milk products, and vegetables including potatoes and carrots. Complex carbohydrates are better sources of energy than sugar since these are released slowly. Sources of complex carbohydrates are breads, cereals (rice, wheat, bajra, corn, barley, ragi, etc.). We should consume starch and natural sugar and eat whole grains, rice, bread, cereals and fruits to obtain adequate amount of carbohydrates. Fast food items such as pizza, pasta, noodles, etc. are rich in carbohydrates only and cannot replace a balanced meal.

#### 11.2.1.3 Fats

Fats and oils are concentrated sources of energy. Fats are substances that our body stores for future use. These are classified as simple lipids (e.g. triglycerides), compound lipids (e.g. phospholipids), and derived lipids (e.g. cholesterol). Fats may be obtained from animal or vegetable sources. The major sources of animal fats are ghee, butter, milk, cheese, eggs, fish and meat. The sources of vegetable oils are groundnut, mustard, sesame, coconut, etc. Excess carbohydrates are converted into fats. Fast food items like *pizza*, *samosas*, *burgers* are rich sources of fat. Therefore, children who consume only fast food items tend to become obese.

#### 11.2.1.4 Vitamins

Vitamins are organic substances that we require in adequate quantities for good health. Our body, however, cannot synthesise them. Therefore, we need to consume their natural sources such as fruits and vegetables. Vitamins are divided



Fig 11.3 : Carbohydrates and Vitamins



into two groups—fat soluble vitamins (Vitamins A, D, E, and K) and water soluble vitamins (Vitamins of B group and Vitamin C). Each vitamin has a specific function and its deficiency leads to a particular deficiency disease.

#### 11.2.1.5 Minerals

Minerals are the nutrients that are very essential for proper growth and functioning of our body and are required in small amounts. Calcium, Chlorine, Copper, Fluoride, Iodine, Iron, Magnesium, Manganese, Phosphorus, Potassium, Sodium and Zinc are essential mineral nutrients. Some of them are explained below.

**Table 11.1 : Vitamins — Sources, Need and Deficiency Disease**

Name of Vitamin	Sources	Need	Deficiency Diseases
Fat soluble Vitamins			
Vitamin A	Milk, butter, egg, carrots, cod liver oil, tomatoes, pumpkin, green leafy vegetables	Normal growth and to keep eyes and skin healthy	Night blindness, Irregular growth of teeth
Vitamin D	Cheese, butter, milk, green vegetables, fish liver oil, sunlight	Formation of strong bones and teeth	Rickets
Vitamin E	vegetable oils, spinach, lettuce, turnip leaves, butter, milk, whole grains, nuts, seeds, leafy vegetables	Protection of cell membrane, formation of red blood cells (RBC)	Not yet confirmed
Vitamin K	Cabbage, cauliflower, spinach and other green leafy vegetables, cereals, soyabeans	Clotting of blood	Excessive bleeding from wounds
Water soluble Vitamins			
Vitamin B1 (Thiamin)	Seafood, milk, meat, peas, cereals, green vegetables	Growth and development, releasing energy from carbohydrates	Beri beri

Vitamin B2 (Riboflavin)	Yeast, egg, meat, peas	Body growth and red cell production, releasing energy from carbohydrates	Skin diseases, retarded growth
Vitamin B3 (Niacin)	Whole cereals, tomatoes, potatoes, meat and fish	Healthy skin, digestion and nervous system	Pellagra (affects skin, alimentary canal and nervous system)
Vitamin B12	Liver, milk, eggs, fish	Forming RBC	Anaemia
Vitamin C	Indian gooseberry (amla), lemons, lime, pineapple, oranges, watermelon, green peppers, tomatoes, cabbage, turnip, carrots, green mint, guava	Maintenance of ligaments, tendons, other supportive tissues and blood vessels	Scurvy (gums swell and bleed)

#### 11.2.1.6 Water

Water is a nutrient and it makes up almost 70 per cent of our body weight. We need water to break down complex food molecules, and transport food, chemicals and gases throughout the body. It acts as the medium for biochemical reactions and is also required to eliminate the wastes as urine and sweat. We should take 8 – 10 glasses of potable water per day. Inadequate water intake leads to dehydration. Therefore, intake of water in proper proportion is important. We should never substitute water with coffee, tea or soft drinks.

**Table 11.2 : Important Minerals — Sources and Functions**

Name of Mineral	Sources	Need
Iron	Meat, fish, liver, eggs, green vegetables, turnip, germinating wheat grains and yeast	Formation of haemoglobin

Calcium	Milk and milk products, green leafy vegetables.	Formation of strong bones, teeth; clotting of blood; muscle contraction
Phosphorus	Meat, egg, fish, whole grains	Development of strong bones, teeth; making energy-rich compounds in cells
Potassium	Green and yellow vegetables	For growth; keeping cells and blood healthy
Sodium	Common salt, also in meat and milk products	Proper functioning of nervous system
Iodine	Iodised salt, seafood and water	Proper functioning of thyroid – deficiency causes goitre
Fluoride	Coffee, spinach, onion and tea	Makes enamel of teeth hard and prevents dental caries
Copper	Grains, nuts and chocolate	Helps in formation and functioning of RBC, connective tissue and nerve fibres
Zinc	Meat, eggs and fish	For insulin production, digestion, metabolism; functioning of male prostate
Chloride	Meat, milk products and fish	Functions of muscles and nerves and digestion

### ACTIVITY 11.3

Prepare a list of food items you consumed last week at breakfast, lunch and dinner, and record the nutrients contained in by them.

### ACTIVITY 11.4

Find out the number of glasses of water each of your ten classmates consume in a day.

### 11.3 BALANCED DIET

You have already learnt in earlier classes that a diet which contains all the essential nutrients like proteins, carbohydrates, fats, minerals and vitamins in the proportion required for the normal growth and development of the body, is called balanced diet. The quantity of nutrients in a balanced diet will always vary with age, sex and physical activities undertaken by an individual. The important components of a balanced diet are given in table 11.3 below.

**Table 11.3 : Food Required for a Normal Person**

Food Group	Quantity per portion/serving
Cereals	1 <i>roti</i> (25 gm wheat flour), bread, 1 <i>katori</i> rice, 25 gm raw <i>dalia</i> /cornflakes/ <i>sooji</i> or <i>rawa</i>

Pulses	25 gm raw <i>dal</i>
Milk	1 glass or 250 ml milk (low fat)
Fruits and vegetables	100 gm fruit, 100–125 (gm) raw vegetables
Fats and oil	1 teaspoon (5 gm)

Source: Health Awareness for Parliament, MOHFW; GOI: 2002

To understand which kind of food will give us the right balance of nutrients, food items are divided into six major groups given in the table below. Food items in one group cannot replace those in another.

A nutritionally balanced diet should contain items from all the above major food groups.

**Table 11.4 : Major Food Groups**

Food Groups	Food Items	Nutrients
Cereals, Millets	Rice, wheat, <i>bajra</i> , maize, <i>jowar</i> , <i>ragi</i>	Carbohydrates, proteins
Pulses	Lentil, grams, soya, peas	Carbohydrates, proteins
Milk and milk product	Milk, yogurt, cheese, <i>paneer</i> , ice-cream	Fats, proteins, minerals, water, carbohydrates, vitamins
Meat, fish and fowls	Meat, fish, chicken, nuts	Proteins, fats
Vegetables	Green leafy vegetables, roots minerals, water	Carbohydrates, vitamins
Fruits	Orange, banana, apple etc.	Carbohydrates, vitamins

### 11.4 SPECIAL DIETARY REQUIREMENTS

The amount of food or nutrients required by a person in a day depends upon the need for energy and specific demands of a person. These needs are directly related to age and physical activity. During the rapid growing years, i.e. 12 – 22 years for boys and 12 – 18 years for girls, there is a gradual increase in daily food requirements. But as we grow old, our daily need for energy decreases. The amount of energy required by people engaged in low, moderate or high level of physical activity differs.

A sportsperson always needs to consume more calories than a non-sportsperson. Similarly, the dietary needs of a woman during pregnancy and lactation are higher. Let us discuss the dietary requirements of different individuals.

**Box 11.1**

Food habits such as eating fast food regularly, skipping meals, etc. contribute to nutritional deficiency among adolescents, especially girls.

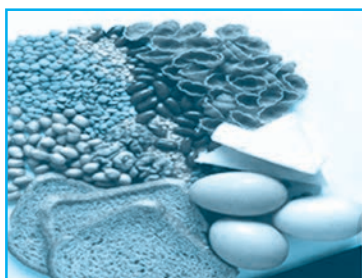

Fig. 11.4 : Calcium rich Diet and Iron rich Diet

**ACTIVITY 11.5**

1. List the myths in respect of diet for adolescent girls, pregnant and lactating women, prevalent in your locality.
2. Express your opinion regarding these myths.
3. Discuss these myths with your friends and teacher.

**11.4.1 Diet for Adolescents**

We know that during adolescence, changes take place in the body composition of boys and girls; and as a result their nutritional requirements increase. Girls need more minerals like calcium and iron. Adolescent girls and boys need to take calcium rich food to keep their bones, teeth and muscles healthy; and iron rich food to keep them strong. Therefore, it is essential for them to consume more dairy products, beans and green leafy vegetables in their diet. Young girls taking inadequate diet may suffer from nutritional problems like iron-deficiency anaemia and obesity. This may be due to refusal to eat food to maintain weight or binge eating habit. Furthermore, an under nourished adolescent girl is at a risk of developing complication during pregnancy and child birth.

**11.4.2 Diet for Pregnant Women and Lactating Mothers**

Women always require more iron than men. Pregnant and lactating mothers have special dietary needs. In our country, it is seen that pregnant and lactating women do not take healthy diet because of lack of availability and lack of important nutritional information. A pregnant and a lactating mother requires additional energy over and above her normal requirements. There is also an increased need for protein, calcium and iron. Inadequate intake of nutrients causes harm to the foetus and the child. Mothers should follow the guidelines for intake of nutrients available from the nearby health centre and gather knowledge regarding weight gain and supplementation. Besides food, normal physical activities and light exercises like walking should be performed by pregnant women in consultation with the doctor or health worker.

Good nutrition during pregnancy promotes healthy weight of the newborn. Low birth-weight children are prone to various diseases during adulthood. Therefore, pregnant women and mothers should keep the following in mind.

- Include all food groups in daily diet. Care should be taken to include cereals, pulses, ghee-oil, sugar, jaggery, vegetables, fruits, milk and its products in the daily diet.

**Table 11.5 : Additional Calorie Requirement during Pregnancy and Lactation**

Food Item	During Pregnancy		During Lactation	
	Quantity	Calories (kcal)	Quantity	Calories (kcal)
Cereals	35g.	118	60g.	203
Pulses	15g.	52	30g.	105



Milk	100	83	100	83
Fat	NA	NA	10g.	90
Sugar	10g.	40	10g.	40

Source: ICMR (1990) Recommended Dietary Intakes for Indians, New Delhi

- Consume more foods containing iron like green leafy vegetables, black sesame seeds (til), raisins, jaggery, *poha*.
- Consume more foods like milk and its products (viz. curd, *paneer*, *kheer*), white sesame seeds (til), *ragi*, guava and *bajra*, which provide all the calcium and protein needed.
- Do not restrict diet. Have a balanced diet.
- Table 11.5 presents the additional calorie requirement during pregnancy and lactation.

### 11.4.3 Diet for Sportspersons

All kinds of physical activities burn a lot of energy. Sportspersons undergo physical training which involves regular strenuous exercises for a long period for developing physical fitness and improving performance. They, therefore, need more calories for energy. Even persons who do not participate in competitive sports but undertake exercise programmes for physical fitness need extra energy. Accordingly, they are required to plan their diet.

Let us have a look at the table given below to understand the energy expenditure of a person of age between 20 to 39 years, with a body weight of approximately 60 kg by various activities.

These additional requirement of nutrients for training load can be achieved with a balanced diet. In the past, athletes were advised to take large amount of protein from eggs, meat and milk, but it is now generally accepted that carbohydrate and not protein, is the best source of energy. One should also remember that extra protein intake does not increase muscles.

**Table 11.6 : Energy Expenditure of a Person by Various Physical Activities (kcal/hr)**

Activity	kcal/hr	Activity	kcal/hr
Cleaning/mopping	210	Walking 4 km/hr	160
Gardening	300	Running 6 km/hr	353
Cycling 15 km/hr	360	Running 10 km/hr	655
Volleyball	180	Running 12 km/hr	750
Badminton	348	Dancing	372
Tennis	392	Standing	132

Diet containing complex carbohydrates is always preferred over that containing simple sugar. In case of sportspersons, a dietary carbohydrate intake of 500-600 gm/day is necessary to ensure adequate glycogen synthesis. Carbohydrates break into sugars that give energy. Extra sugar is converted into glycogen and stored as adipose tissue by the liver. It is broken down to simple sugar whenever energy is required. An athlete needs to choose foodstuffs from all groups displayed in the food pyramid and pay attention to the intake of adequate water.

In planning one's diet, care must be taken to follow good eating habits that we discussed earlier. Physical activities may be performed after at least three hours of taking a principal meal and after half an hour of taking light food. A sportsperson's diet is very important not only during the training period, but before and after the competitions too.



Fig. 11.5 : Food Pyramid for Balanced Diet

#### 11.4.3.1 Diet before Competition

The pre-competition meal needs to be high in carbohydrates, low in fat, low in protein, low in fibre, enjoyable and familiar to the participant. Food may include breakfast cereals, bread, *roti*, fruits, fruit juice, boiled rice, potatoes, sweet potatoes, biscuits and carbohydrate drinks.

#### 11.4.3.2 Diet on Competition Day

On the day of competition, the most important thing to remember is never to try anything new. An athlete must follow a simple and sound nutritional routine. If the competition is held in the morning, just eat a light carbohydrate-rich breakfast with plenty of fluids, cereal with milk, bread or *roti*. Large quantities of sugar, confectionery or honey should be avoided. Food that may upset the stomach and make feel heavy may be avoided.

#### 11.4.3.3 Eating just before Competition

Small amount of food containing carbohydrates just before competition helps to delay fatigue and improve endurance.

#### 11.4.3.4 Drinking during Competition

Have your last drink 15 – 20 minutes before actual competition. It is essential to drink water at regular intervals to avoid dehydration. Right kind of sports-drinks hydrate our body and also supply energy.

### 11.5 YOGIC DIET

Ayurveda advise a *sattvic*, which is a vegetarian diet, consisting of natural food items. According to yogic dietetics, natural food items are easy to digest and assimilate. Yogic diet is a combination of raw food and proper fasting routine. Good raw food, such as cucumber, radish, carrots, tomatoes, sprouts, together with spices like ginger, cayenne, cinnamon and basil provide energy to the mind and the body. Taking regular yogic diet and performing *asanas*, *pranayama* and meditation contribute to the well-being of our body and mind. For preparation of yogic foods, steaming is considered to be the best method.

### 11.6 MALNUTRITION

It is now clear that a balanced diet is very important for a healthy life. An imbalance between the body's nutritional needs and the intake of nutrients leads to malnutrition. Commonly malnutrition is considered in terms of hunger, whereas, both under-nutrition and over-nutrition are forms of malnutrition.

#### Box 11.2

Ayurveda suggests the following items in a wholesome diet

- Rice
- Millet
- Wheat
- Green gram
- Coriander
- Vegetable
- Grapes, mangoes, Dates
- Cow's milk
- Turmeric (*haldi*)
- Cumin (*jeera*)
- Do not fill your stomach with extra food.
- Eat food at regular intervals.

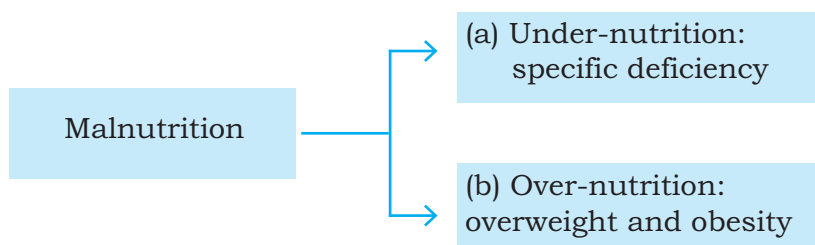

### Box 11.3

Nutritional imbalance resulting from inadequate intake of nutrients is referred to as under-nutrition.

## 11.6.1 Types of Malnutrition

### 11.6.1.1 Under-nutrition

It does not occur in a single day's food intake. Deficiency caused by under-nutrition affects us after long term of negligence. An under-nourished child cannot grow fully, physically and mentally. In most of the developing countries, under-nutrition is a threat to public health as it leads to illness and even death. In addition to inadequate intake of nutrients, under-nutrition

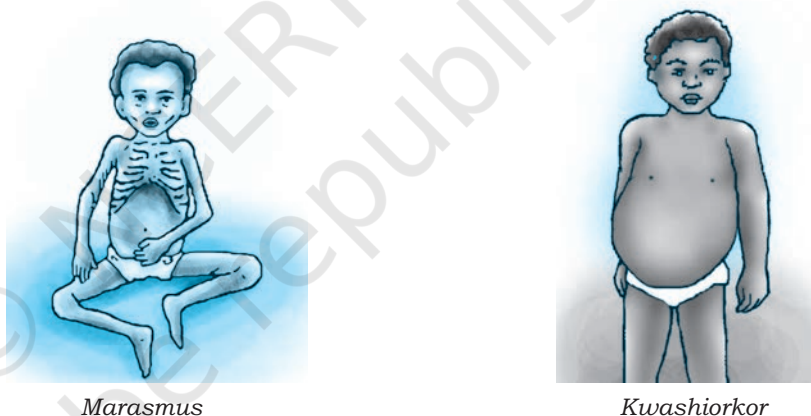

Fig. 11.6 : Under-nutrition children

is also the result of malabsorption of food, addiction to drugs or loss of nutrients from body due to various medical reasons. Under-nutrition may lead to deficiency diseases, like protein deficiency diseases which include kwashiorkor, marasmus, mineral deficiency diseases like goitre, anaemia; and vitamin deficiency diseases like scurvy, beriberi and rickets.

Ignorance, lack of education and poverty led by relatively high food prices, natural disasters causing insufficient agricultural productivity and unhealthy dietary practices are some important common causes of under-nutrition. Under-nutrition continues to be a significant health problem for children and adults in India. The National Family Health Survey 3 (NFHS) reported that in our country the prevalence of



under-nutrition is high among children. At present, 40 per cent children of less than five years of age in our country are underweight.

For the management of under-nutrition, improvement in nutritional status is required. The Government of India provides mid-day meals to the students of up to elementary stage during school hours.

Many myths and taboos about diet are also responsible for under-nutrition in our country. Due to ignorance and illiteracy, locally available nutritious food is not eaten. In case of new born babies, inadequate breastfeeding is a major cause of under-nutrition. In fact, exclusive breast feeding during the first six months of life is very important.

#### 11.6.1.2 Over-nutrition

Over-nutrition is also a form of malnutrition that results from overeating and excessive intake of specific nutrients like carbohydrate and fat. Inadequate exercise and overeating are the major causes of overweight. Due to intake of excessive food, adipose tissue increases abnormally in the body that enlarges or the number of fat cells increase leading to obesity. We find obese persons bulky and overweight because of the accumulation of fat in the body. People who eat more need to burn more calories, otherwise surplus calories are stored as fat.

In modern societies obesity has become an epidemic. It occurs in both developed and developing countries and affects children as well as adults. In addition to overeating and inactivity, the major reasons of overweight and obesity are sedentary life style, emotional problems and physiological disturbances including genetic factors. Metabolic and digestive disorders take place due to over-consumption of fats, fast foods, soft drinks and refined white flour carbohydrates, combined with low fibre intake.

Overweight and obese children and adolescents frequently grow to become obese adults. Obesity tends to run in families, suggesting a genetic link too, as families share common dietary and physical activity patterns, attitude, lifestyle and habits which contribute to obesity. Planning for balanced diet and regular exercise is of utmost importance to prevent overweight and obesity.

### ACTIVITY 11.6

Conduct a survey in your family and the neighbourhood to find out facts regarding the following:

1. How many malnourished children are there?
2. What are the reasons of malnourishment of those children?



Fig. 11.7 : Over-nutrition

### Box 11.4

**Obesity:** Overweight and obesity are not the same. Obesity is a health condition in which excess body fat accumulates to the extent that it may have an adverse effect on health and reduce life expectancy. When body fat content exceeds 25 per cent for men or 30 per cent for women of the total body weight, a person is called obese. Calculating BMI is given in Chapter 4?



### 11.6.2 Assessing the BMI

Body Mass Index (BMI) is an index of weight-for-height that is commonly used to classify adults as underweight, overweight and obese. It is obtained by dividing the weight in kilograms by the square of the height in metres ( $\text{kg}/\text{m}^2$ ). For example, an adult who weighs 70kg and whose height is 1.75m will have a BMI of 22.9.

**Table 11.7 : BMI Chart**

BMI	Category
<18 $\text{Kg}/\text{m}^2$	Underweight
18-23 $\text{Kg}/\text{m}^2$	Ideal body weight
23-25 $\text{Kg}/\text{m}^2$	Overweight
>25 $\text{Kg}/\text{m}^2$	Obese

Source: National Programme for Prevention and Control of Cancer, Diabetes, Cardiovascular Diseases and Stroke: A Guide for Health Worker. Directorate General of Health Services, MoHFW; GOI, 2011



Fig. 11.8 : Anorexia Nervosa

## 11.7 EATING DISORDERS

Eating disorders are severe disturbances in eating behaviour commonly seen among adolescents between ages 14 to 18 years. Disordered eating patterns are either characterised by refusal of food to maintain the body weight or recurring binge eating followed by vomiting. The former restrictive type disorder is known as Anorexia Nervosa and the later, Bulimia Nervosa. Most people do not seek help for eating disorders; some may not even be aware that they have a problem.

### 11.7.1 Anorexia Nervosa (AN) (Refusal to eat food)

Anorexia Nervosa is a psychological disorder caused by under-nutrition. People with such disorder become thin and lose a lot of weight. An obsessive fear of gaining weight occurs in such cases. Anorexia nervosa is an attempt to use food and weight to deal with emotional problems, physical changes, peer pressure and stress. It is a serious mental illness with a high incidence of morbidity and mortality.

Extreme fasting, indulging in over exercise, dieting may result in anorexia nervosa. Teenage girls and young women are more likely to develop this disorder. However, this disorder can occur during adulthood too.

### 11.7.2 Bulimia Nervosa (Recurrent binge eating)

Bulimia Nervosa is an eating disorder characterised by recurrent binge eating, followed by compensatory behaviour. The most commonly observed behaviours include defensive vomiting, sometimes called purging, fasting, using laxatives and over-exercising.

### Box 11.5

Anorexia Nervosa results from refusal to eat or lack of appetite or disliking food leading to starvation to maintain a body image.

The onset of bulimia nervosa is generally observed during mid to late adolescence. It is 20 times more common in females. Bulimia nervosa is rarely seen in those under 14 years. It has also been observed that there is higher incidence of major depressive disorder in close relatives of patients with bulimia nervosa.

The common causes of the disorder are family problems, inability to adjust in society, lack of self-identity, conflict, problem with body image, depression and other psychological problems. The person tries to express emotions that are otherwise difficult, becomes extremely engaged with emotions and is so tied up with a relationship with food and weight that it becomes difficult for him/her to deal with it.

Health problems caused by both the above conditions include:

- (a) tooth decay, toothaches, swollen gums, gum disease (gingivitis), and erosion of tooth enamel, which are caused by acid in the mouth due to vomiting.
- (b) osteoporosis.
- (c) abnormal heart beat.
- (d) dehydration, which can lead to weakness, fainting.
- (e) fainting due to low blood pressure.
- (f) low body temperature.
- (g) suicide risks when a person feels discouraged due to presence of one of the conditions or has ongoing body image issues.

Anorexia and bulimia can lead to delay in the onset of menstruation in girls.

There is a need to focus on fitness rather than on weight reduction. Sitting in front of TV or computer for long hours, eating junk food, or having high calorie drinks add to obesity. It is seen not only in the affluent section but also in urban poor. Since obesity is more a lifestyle disease, it needs intervention at the level of the person himself/herself and at the level of the entire family, school and the community. Proper eating habits, diet and exercise are the essential requirements for physical fitness and management of weight.

## ASSESSMENT

### Answer the following questions

1. Define the terms nutrition and nutrients.
2. List the various constituents of food and mention their function in the body.
3. Why is it important to recommend special diet for pregnant and lactating women and sportpersons.
4. Why is water considered a necessary constituent of the diet?
5. List the nutritional disorders and state one characteristic of each.

### Fill in the blanks

- (i) Vitamin A is a .....soluble Vitamin.
- (ii) Vitamin C is a .....soluble Vitamin.
- (iii) ..... diet contains adequate proportions of carbohydrates, proteins, fats, minerals and vitamins.
- (iv) Yogic diet consists of natural .....items.
- (v) BMI can be assessed by.....

### Tick (✓) mark either Yes/No.

- (i) Water is a nutrient which makes up almost 70 per cent body weight. (Yes/No)
- (ii) One should consume 6 – 8 glasses of water every day. (Yes/No)
- (iii) Over-nutrition leads to obesity. (Yes/No)
- (iv) Wheat and vegetables are the source of vitamin E. (Yes/No)
- (v) Milk and milk products are the source of calcium. (Yes/No)

### PROJECT

- How do bulimia nervosa and anorexia nervosa pose serious health issues for adolescents?
- Prepare a chart on the benefits of locally available food/ balanced diet.
- How do you think media influences the eating habits of young people?
- Create an advertisement for selling healthy food and suggest how you can build awareness on healthy eating habits among your peers.

# First Aid and Safety

# 12



13149CH12

## 12.1 INTRODUCTION

We all observe that when individuals fall ill or are injured, they are taken to hospitals or doctors for treatment. But it takes time to reach them, during which if some initial care is taken, it helps treatment of such individuals and in many cases saves their lives. We also observe that some of the minor illnesses or injuries are cured by taking such initial care. However, this care cannot be taken unless we are aware and trained in first-aid. In the present lesson we shall discuss various aspects of first aid and safety.

## 12.2 WHAT DOES FIRST AID MEAN?

First aid is the provision of initial care for an illness or injury. It is usually performed by a non-expert person to a sick or injured person until appropriate medical treatment can be accessed in a hospital or by going to a doctor. Certain self-limiting illnesses or minor injuries may not require further medical care after the first aid intervention. It generally consists of a series of simple and in some cases, potentially life-saving techniques that an individual can be trained to perform with minimal equipment.

The First aid training, therefore, is of value in both preventing and treating sudden illness or accidental injury and in caring for large number of persons caught in a natural disaster. It is a measure both for self help as well as for the help of others.

### 12.2.1 Self-help

If you, as a first-aider, are prepared to help others, you are better able to care for yourself in case of injury or sudden illness. Even if your own condition keeps you from caring for yourself, you can direct others in carrying out correct procedures to follow on your behalf.

### 12.2.2 Help for Others

Having studied first-aid, you are prepared to give others some instruction in first-aid, to promote among them a reasonable safety attitude and to assist them wisely if they are stricken. There is always an obligation on a humanitarian basis to assist the sick and the helpless. There is no greater satisfaction than that resulting from relieving suffering or saving a life.



Fig. 12.1 : First Aid Box

## ACTIVITY 12.1

- Make a first aid box and keep in your classroom.
- Make one student incharge so that all students know whom to reach in an emergency.

## ACTIVITY 12.2

- Do you know how to apply bandage?
- Do you know what treatments are applied for bruises and cuts?
- Discuss the above in your class and demonstrate.

## 12.3 WHY FIRST AID?

### Box 12.1

The basic objectives of First Aid are:

- to give immediate care.
- to protect the casualty from further harm.
- to relieve pain.
- to promote recovery.

The recovery is promoted as the heart rate goes down, which in turn prevents blood loss from the victim's body.

The main objective of first aid is not to cure, but to ensure safety until the patient or affected person accesses specialised treatment. It is the initial assistance or care of a suddenly sick or injured person. It is the care administered by a person as soon as possible after an illness or accident. It is this prompt care and attention prior to the arrival of the ambulance that sometimes creates the difference between life and death, or between a full or partial recovery. As shown in Box 12.1, the major objectives of first aid are: (i) to ensure that the victim

reaches the place of specialised treatment safely and life is not lost in-between; (ii) to prevent further harm, i.e., the injury that has taken place, does not deteriorate further; (iii) to prevent the danger of further injury; and (iv) to promote recovery, i.e., necessary intervening care is taken in a way that promotes recovery and relieves the victim of pain and uneasiness.

## 12.4 FIRST AID IN DIFFERENT CASES

It is essential to know and be trained in the art of providing first aid. Though it is done by non-expert persons, it cannot and should not be administered without acquiring adequate knowledge and appropriate skill. There are different ways of providing first aid in different cases of accidents and illnesses. Let us take some specific cases and know how first aid is provided.

### 12.4.1 First aid for Drowning

Many deaths occur because of drowning. Death by drowning occurs when air cannot get into the lungs because of the entrance of a small amount of water into the lungs. This may cause the contraction of the throat. In such cases efforts are made to remove water from the stomach of the drowned person. Attempting to forcefully remove water from the victim's stomach should be avoided as this may make the victim vomit and there are chances of casualty. A casualty from drowning needs to be treated by a medical doctor, even if he/she seems to recover, because, as explained in Box 12.2, a secondary drowning may occur in him/her at a later stage.

In this particular situation, the aim of the first aid is to restore breathing, to keep the person warm and to arrange for taking him/her to hospital. The following steps may be taken:

### Box 12.2

Water entering the lungs causes them to be irritated, and the air passages to swell several hours later—a condition known as secondary drowning.



- Step 1:** Rescue the person and get him/her to the dry land. Keep the person's head lower than the rest of the body to reduce the risk of inhaling water.
- Step 2:** Lay down the person on his/her back. Open the airway and check breathing. If required, give CPR (Cardio Pulmonary Resuscitation) with chest compression.
- Step 3:** Treat the person for Hypothermia (low body temperature). Remove wet clothes and cover him/her with dry blanket. If the person regains full consciousness, give him/her a warm drink.
- Step 4:** Call for a doctor or ambulance to transport the person to the nearest hospital as soon as possible, even if she/he appears to have recovered fully.



#### 12.4.2 First aid for Fire Injuries

When the skin comes in direct contact with fire, it gets damaged. This is known as dry burn. The burn exposes the under lying part of the skin, which increases the chances of infection. While assessing the burn, it is necessary to:

- consider the circumstances in which the burn has occurred;
- establish the cause of the burn;
- observe the condition of the victim; does she/he need immediate medical attention?
- assess the extent of burn or the depth of the burn; and
- determine the degree of risk for infection.

Based on the depth of the skin damage, the burns are categorised into three types.



Fig. 12.2 : Steps for CPR in the case of drowning

#### ACTIVITY 12.3

The students should be encouraged to ask questions if they have any doubt on the procedure of the first aid in swimming. If the swimming facility is available then the life saving technique of drowning can best be practised by doing. In the classroom or physical education laboratory the students may make use of dummies.

#### Box 12.3

**Warning** – Water in the lungs can increase the resistance to rescue breathes and chest compressions, so these have to be done at a slower rate. **Hypothermia** develops when the body temperature falls below 35° Celsius. The effects vary depending on the speed of onset and the level to which the body temperature falls.

- **A superficial burn** involves only burns on the outer most layer of the skin, called the epidermis.
- **A partial thickness** burn is generally very painful, this destroys the epidermis. If such wounds are on more than 20 per cent of the body, then it may be fatal.
- **A full thickness** burn is not painful in most of the cases, so it may mislead the first-aid and the casualty about the severity of the injury. This needs immediate medical attention.

As, the kind of the burns vary, so does the kind of first aid needed for various kind of burns.

#### (a) First Aid for Severe Burns

In this case, the first aid is given to :

- stop burning and relieve pain;
- treat the associate injuries;
- minimise the risk of infection;

In case of severe burn the following steps need to be taken.

**Step 1:** Help the casualty to lie down. Do not allow the injury area to come into direct contact with the ground.

**Step 2:** Pour cold water on the burn for a minimum of 10 minutes, but at the same time, arrangement of transport for taking the casualty to hospital should be made. Continue cooling the affected area until the pain is relieved.

**Step 3:** Gently remove any ring, watch, belt and shoes before the tissues begin to swell. Carefully remove burnt clothing, if it is not sticking to the skin.

**Step 4:** Cover the injured area with a sterile dressing to protect it from infection.

**Step 5:** Gather and record details of the injury. Record the level of response, pulse and breathing carefully.

**Step 6:** While waiting for the help to arrive, keep reassuring the casualty. In case of burn of the face, do not cover the injury because it may cause discomfort to the victim. Keep cooling the area till the doctor arrives.

#### (b) First Aid for Mild Burn

In case of mild burns, first aid is given to :

- stop burning.
- relieve pain and swelling.
- minimise the risk of infection.

In case of mild burns, one should :

**Step 1:** Pour cold water on the injured part for minimum 10 minutes, to relieve pain. If water is not available, then any harmless cold liquid (for example, milk) may be used.

### ACTIVITY 12.4

Find out from a health worker, parents or neighbour about any person who was given first aid for burn injuries. Share the experience in the class.

### Box 12.4

#### Do Not

- Break blisters.
- Interfere with the injury.
- Apply adhesive dressing.
- Apply ointments or fats, as they may damage the tissue and increase the chances of infection.

**Step 2:** Remove gently any ring, watch, belt and shoes before the tissues begin to swell. Carefully remove burnt clothing, if it is not sticking to the skin.

**Step 3:** Cover the area with a sterile dressing and bandage loosely on the affected area.

**Step 4:** If a blister is caused by the burn, apply a non-adhesive dressing that extends well beyond the edges of the blister and keep it in place until it subsides. One should be aware of two significant facts given in boxes 12.5 and 12.6.

**(c) First Aid for Injuries on the Play Field**

Injuries which occur as a result of participation in the sports activity are known as sports injuries or athletic injuries. There are various types of sports injuries. These are mentioned in the following table 12.1.

**Table 12.1**

Injuries	Types
Skin injuries	<p><b>Abrasion</b> (falling on rough or firm surface)  <b>Laceration</b> (tears in the skin)  <b>Incision</b> (cut by a sharp edge of an object)  <b>Puncture wound</b> (pierced by a sharp and pointed object)  <b>Avulsion</b> (tearing away of a part of the skin)</p>
Soft tissue injuries (e.g. muscles, ligaments)	<p><b>Contusion</b> (Bruise caused by the direct blow to some part of the body. For example: Knee of a player is knocked against thigh of the person).  <b>Sprain</b> (Injury of ligament of joints, caused by the violent overstretching of ligament in a joint or the movement of the joint in abnormal directions. It is characterised by pain, tenderness, swelling at the joint).  <b>Strain</b> (Injury of muscle or tendon, three types– mild, moderate, severe).</p>
Joint injuries	<p>Joint injuries are very common in sports they are known as joint dislocation.  <b>“Dislocation is the displacement of contiguous surfaces of two or more bones which are in a joint.”</b> Causes: An external force which forces the joint to move beyond the limits of a joint. If the joint is forced to move in an abnormal direction, this dislocation can be a complete or a partial displacement of the bones.</p>

**Box 12.5**

**CALLUSES**

These are thickening of the epidermis. It usually occurs in the palm of the hands or on the sole of the foot due to constant friction or pressure. If the calluses crack then it will cause a very painful condition. Sometimes a blister may develop under the callus. When it becomes very hard, to prevent cracking, soak the body part in the water for some time and then scrub it off. If it gets infected then consult a doctor.

**Box 12.6**

**BLISTERS**

These are caused by the deposition of a type of colourless fluid in between the dermis and epidermis. Sometimes this fluid may be blood stained; this is due to the damage of the blood vessels caused by the continuous frictional force. It is normally seen on the hand or palm or on big toe. Blisters should not be cut, rather the fluid inside can be removed by a sterile syringe, but only by a doctor.

Bone injuries	<b>Fractures</b> (Fracture is a break in the continuity of the bone. The fractures can be open/compound fracture or a closed/simple fracture. Severity of the fracture varies from the mild crack in the bone to the severe shattering of the bone into many pieces.
---------------	--

**Box 12.7****RICE**

- R - Rest
- I - Ice
- C - Compression
- E - Elevation

**Prevention**

Since prevention is better than cure, it then becomes essential to take appropriate precautions. Make the area in and around the play field hazard free. In order to prevent injuries proper warm up is required prior to executing vigorous movements. Similarly, use of appropriate physical conditioning is essential to avoid injury.

First aid for strains, sprains, contusions is packaged in the abbreviation RICE which is Rest, Icing, Compression and Elevation as shown in Box 12.5.

**Rest**

- Stop using injured part or discontinue activity. It could cause further injury, delay healing, increase pain and stimulate bleeding.
- Use crutches to avoid bearing weight on injuries of the leg, knee, ankle and foot.
- Use splint for injuries of the arm, elbow, wrist and hand.

**Ice**

- Ice application contracts blood vessels.
- Helps stop internal bleeding from injured capillaries and blood vessels.
- Hastens healing time by reducing swelling around injury.
- Keep damp or dry cloth between skin and ice pack.
- Do not apply ice for longer than 15 to 20 minutes at a time.
- Apply every hour for 10 to 20 minutes.
- Apply ice as long as pain or inflammation persists.

**Compression**

- Hastens healing time by reducing swelling around injury.
- Decreases seeping of fluid into injured area from adjacent tissues.
- Use elasticised bandage, compression sleeve, or cloth.
- Wrap injured part firmly.
- Do not impair blood supply.
- Too tight bandage may cause more swelling.
- Wrap over ice.
- Loosen the bandage if it gets too tight.

**Elevation**

- Elevate injured part above the level of heart.
- Decreases swelling and pain.
- Use objects and pillows.

**12.5 TRANSPORTING THE PERSON FOR MEDICAL HELP AFTER GIVING FIRST AID**

Medical evacuation of the sick and wounded (with medical care) is the responsibility of the medical personnel who have been provided special training and equipment. Therefore, unless there is an emergency, wait for some means of medical evacuation to be provided. When the situation is urgent and you are unable to obtain medical assistance or know that no medical evacuation facility may be available, you yourself will have to transport the casualty. For this reason, you must know how to transport without increasing the seriousness of his/her condition.

**ACTIVITY 12.5**

The school authorities must provide practical exposure to students by organising a First Aid training programme in the campus.

© NCERT  
not to be republished





## ASSESSMENT

### Answer the following questions

1. What is first aid?
2. What are the various kinds of injuries caused sometimes, due to participation in sports?
3. What is a burn injury? How many kinds of burn injuries are there?
4. If someone gets a burn injury what will you do first?
5. Mark the statements as True/False.
  - (i) A first-aider must not panic, so that she/he can help in early transportation of the victim to the hospital.
  - (ii) When an injury occurs in sports, then the activity causing injury must be stopped immediately.
  - (iii) First aid is meant for sportspersons only.
  - (iv) The primary aim of the first aid is to save the life of an individual.
  - (v) First aid is provided by a medical doctor only.

### PROJECT

1. List the items which should be kept in the first aid box.
2. Prepare a first aid kit in consultation with the teacher concerned. Keep it in the classroom. (Activity 12.1)
3. Discuss with students how you will ensure that all items are always present in the first-aid box.

# Social Health

13

## 13.1 INTRODUCTION

We have discussed health in previous chapters. By now you must have realised that health does not only mean freedom from diseases. It is much more. Health is the state of physical, mental and social well-being. It should be viewed in a holistic way. An individual may be physically and mentally healthy, but if her/his social condition is problematic, she/he cannot achieve holistic health. In the present chapter, we shall focus on various aspects of social health.

## 13.2 WHAT IS SOCIAL HEALTH?

Let us first understand the meaning of social health. We know that social health is one of the three major components of health, the other two being physical and mental. Social health can be defined in two ways. In one sense, it refers to the health of a person with reference to her/his ability to interact with others. It also refers to the health of a society in general. It focuses on how the members of a society treat each other and behave with each other. What kind of social environment prevails and how the prevailing customs and traditions guide the behaviour of individuals towards self, each other and towards the society as a whole also form social health. Social Health also includes how individual's natural environment around them is. The role of the community as a whole acquires great importance for enhancing and maintaining the quality of the health of individuals. Although there are many dimensions of social health, we shall discuss below the impact of social customs on our health, the need to protect natural resources and the empowerment of community for healthy living.

## 13.3 IMPACT OF SOCIAL CUSTOMS

Customs and traditions prevalent in a society influence all aspects of the lives of individuals, including their health and welfare. What people eat, how they eat, how they live and care for their own health as well as the health of their near and dear ones are influenced by the prevailing customs and traditions. Let us first understand the meaning of the term custom.

### 13.3.1 What is a Custom?

Customs generally refer to beliefs, habits or actions performed in the past and transmitted through time from one generation



13149CH13

## ACTIVITY 13.1

Make a list of customs having a positive and negative impact on the health of individual and society prevailing in your neighbourhood. Share with your classmates their implications on health?

to the next. These are derived from social norms which are rules or standards that guide, control or regulate proper and acceptable behaviour of a group. These norms define the shared expectations of a group and enable people to anticipate how others will interpret and respond to their words and actions if there is a deviation from these norms. For example, there are customs and traditions related to marriage ceremonies. These are observed by not only those who are getting married but also by the other members of the family and community. Many of the customs have positive impact on the relationships in a family and community. However, many of the customs have negative impact as well. For example, there are customs prevalent in many communities, like early marriage or discriminating against female child, or choice of spouse, which adversely affect the health and well-being not only of the female child but of the society as a whole.

### ACTIVITY 13.2

Seema studies in Class IX in a small town. She has two elder brothers. Both the brothers get a lot of attention from the parents. Parents believe that both their sons should get larger portion of milk, cheese and eggs. They tell Seema that her brothers need to be strong as they will grow up to head their families in future. On the other hand, parents tell Seema that she should eat less, otherwise she will look too grown up and big for her age. One day, while in class, Seema told her teacher that she was feeling dizzy. Before the teacher could do anything, she fainted. The teacher took her to a nearby hospital and then went home with her. The teacher told Seema's parents that the doctor had said that it was because of anaemia that she had fainted and that it was very important to ensure that Seema gets good nutrition to remain healthy.

#### Think

1. Do you think the reasons given by Seema's parents for ensuring that their sons get good nutrition while neglecting Seema's nutritional needs are justified? Give reasons.
2. What are the customs related to diet for girls in your family and community?

### 13.3.2 Customs and Health

In every society, the individuals, families and communities observe many customs that have direct bearing on health. From the moment of birth of a child, customs begin to shape experiences and behaviour of the child. In reality, by the time children can think independently, the health-related customs of the family have already become an intimate part of their personalities. They do not question these customs, as they are deeply held and protected by the society. It becomes extremely difficult to change them. Let us understand this by considering what happened to Seema.

The experiences of Seema shows the negative impact of social customs on health.

Let us consider the influence of customs on the thinking and behaviour of individuals in respect of early marriage, breastfeeding practices, family size, preference for male child and substance abuse. All these affect family and community health.

### Early Marriage

Although efforts have been made since long to ensure that marriages take place at proper age, the problem of early marriage and even child marriage is still continuing in many communities in India. The Child Marriage Restraint Act, 1978 stipulates legal age of marriage as 18 for girls and 21 for boys, but social customs encourage early marriage even now. You may have heard the word *kanyadan*. Influenced by prevailing customs, many parents consider it good to marry their daughters even before she attains puberty. The tradition of dowry is another factor for early marriage in India. It is believed that dowry will be lower if the bride is younger in age.

The early marriage custom puts pressure on young married women to prove their fertility resulting in high rates of adolescent pregnancy. Adolescent pregnancy leads to greater health risks for the teenage mother and her child. Biologically, she is yet to attain reproductive maturity. There are chances of prolonged labour that can result in severe damage to the reproductive tract. The available evidence suggests that maternal deaths are considerably higher among adolescent mothers than among mature mothers. The babies born to adolescent mothers generally have low birth-weight. Such babies are more likely to die at birth or in infancy. Early pregnancy increases the risk of maternal and child morbidity and mortality. Early pregnancy also has serious psychological, social and economic consequences. It continues to affect adversely the educational, economic and social status of women and is likely to have negative impact on the quality of life of the family.

In many cases, young girls are married to older men. Such girls do not have the courage to take decisions related to family needs, lack power and are more likely to experience partner violence. National Family Health Survey (NFHS-3, 2005, 2006) reveals that 27 per cent young women and



Fig. 13.1 : Child Marriage is Illegal  
This poster has been designed by Shivani Sharma from Class X, KP ISP Nasik, Maharashtra

### ACTIVITY 13.3

**Read the case study given below and reflect on the question.**

I am Munni. I was born in a very poor family. I am 17 years old now and have two children of age 5 and 3. My parents never thought of educating me. They thought that education is not meant for girls and more so for poor people.

**Questions for reflection**

1. Why was Munni married so early?
2. How early marriage impacted Munni?
3. If you were in Munni's place what would you have done?



### ACTIVITY 13.4

Find answers to the following questions

- In which of the Indian States do we find a large number of girls being married before they attain the legal age of marriage?
- Have you ever thought how early marriage affects both boys and girls, more particularly the girls? Describe.
- Why early marriages in large number continue ignoring the legal provision.
- How it affects the health of mother and child?
- Discuss with your classmates how to convince parents not to marry their children at an early age.

### ACTIVITY 13.5

**Read the case study given below and answer the questions given at the end.**

Sangeeta was studying in Class IX when her marriage was fixed with a person twice her age. Although she wanted to study further, she was pulled out of school because she was the eldest in the family and there were three more sisters to be married off. Soon after marriage, her husband and in-laws started pressurising her to become pregnant as they wanted an heir to their family. Sangeeta was unhappy but she did not have a choice. Within three months of her marriage, she got pregnant. Despite not keeping well during the pregnancy, she was made to do most of the household work. In the fifth month of her pregnancy, she had a miscarriage (abortion). Rather than supporting her through this difficult experience, her in-laws blamed Sangeeta for not giving them an heir.

#### Questions for reflection

1. Who all are responsible for Sangeeta's condition?
2. If you were in Sangeeta's situation, What would you have done?
3. If Sangeeta was a boy, would things have been different? In what ways?
4. What would you do to convince the parents to avoid age related mismatch in the marriage of boys and girls of your locality.

3 per cent young men in the age-group of 15-19 years were married.

#### Breastfeeding

We have seen above the adverse effects of social customs promoting early marriage in our society. But some customs do have positive impact, for example, consider the issue related to breastfeeding. We are aware that traditionally mothers breastfeed their infants for a year or two and sometimes even longer. This has been an accepted norm. But now-a-days, due to paucity of time and as a matter of convenience, some mothers do not breastfeed their infants. Life style concern also comes in the way of breast feeding. They choose to shift to powdered or bottled milk as a substitute for breast milk. Today an increasing number of women are working outside their homes and bottle feeding seems to be considered a more convenient option for them. Those who choose to breastfeed are looked down upon. Breastfeeding in public is also not an acceptable option.

However, there are two significant needs, which make breastfeeding important both for the mother as well as the child. One is nutritional while the other is psychological. While the nutritional benefit of breastfeeding is no doubt very important, the psychological bonding which develops between the child and the mother due to breastfeeding is unparalleled and has a positive impact on the health of both.



There are many reasons why breast milk is healthier. Breast milk contains more than hundred nutrients that cannot be prepared in the laboratory. These nutrients are essential for the healthy growth and development of the child. In fact, the caloric density, protein, carbohydrate and fat in breast milk are very important for the growth of the child. Breast milk is free from contamination by bacteria and is easier for the infant's stomach to digest. Infants who are breastfed for at least eight months have reduced incidence of many diseases. The first secretion from the mother's breast after the birth of the infant is known as colostrum. Scientific studies have shown that it is extremely good for the new born. But in some communities the mother is asked not to feed this fluid to the child, as they ignorantly think it to be impure. Such customs with a negative impact should be discouraged by creating awareness.

### **Family Size, Preference for Male Child**

Another set of customs and tradition that have adverse impact on social health is related to family size. Many people believe that child birth is a gift of God and individuals should not interfere with this divine process. People also have preference for male child. Many a time parents go on giving birth to children, and the size of the family continues to grow, until a male child is born. This belief contributes to increasing number of children in the family. Some parents want to have at least two male children. The preference for male child has been the main cause of discrimination against girls. Girls are considered inferior to boys. Owing to discrimination, nutritional needs of girls are not met adequately. All food items that are served to boys are not given to girls or are given in very less quantity. The girls are also discriminated in availing education facilities. In the process, girls are married off very early.

The discrimination against females has been a grave problem in our society. You must have read about the inverse sex ratio being a problem in our country as discussed earlier. Parents get the pregnancy test done in a clinic and if they find it to be a female foetus, they get it aborted. Many girl children are killed just after their birth.

### **Substance Abuse**

You have already studied in detail about substance abuse in Chapter 2. It is also known as drug abuse which has become a serious problem in our society.

It is important to note that social customs have been closely related with the drug or substance abuse related behaviour of individuals since ages. Indian society, which enjoys cultural diversity, has a history of use of plant products such as,

### **ACTIVITY 13.6**

- Examine the breast feeding publicity material (points, video, posters).
- Which one do you think is more appealing to women and elderly to accept the message of breast feeding.

### **Box 13.1**

Findout sex ratio of your and neighbouring states and analyse the facts.

cannabis, opium, and home brewed alcoholic beverages in celebrating festivals. There are certain social groups which are more vulnerable to substance abuse. On the contrary social customs prescribe that intoxicants should not be taken by children up to a certain age.

Developments of industrialisation, urbanisation with consequent migration have resulted in loosening of the

traditional social control on an individual. Stresses and strains of modern life, the fast changing social milieu, among other factors making people vulnerable to drug abuse. Moreover, the breaking of the joint family system, with limited parental attention and care in modern families where both parents are working, peer pressure, influence of films, and fashion and values have led to a considerable rise in the consumption of drugs, specially among adolescents.

Substance abuse has a negative impact on the family and society. It increases conflicts and causes untold emotional pain for every member of the family. Most of the domestic violence is directed towards women and occurs in the context of demands for money to buy drugs. With

most drug users being in the formative young age, the loss in terms of human potential is incalculable. Substance abuse

### ACTIVITY 13.7

Observe at least five families in your neighbourhood and find out the following

1. How many members are there in each family and how many of them are males and how many females?
2. Are all boys and girls of every family studying? If not, what is the ratio of both? Are both boys and girls in the family studying in the same school of equal standard?
3. How many females of the family are working outside their homes?

Based on the collected facts try to understand the following

- i. Major reasons why certain families are large, while some others are small in size.
- ii. The overall quality of life in large and small families; and
- iii. The status of girls and women in both types of families.

### Box 13.2

#### Facts about Substance Abuse by Young People in India

- Substance (drug) abuse is fast emerging as a problem. Twenty-four per cent of the drug users were in the age group of 12-18 years. The subjects in treatment centres reported that about 11 per cent of them were introduced to cannabis before the age of 15 years, and about 26 per cent between the age of 16 and 20 years (United Nations Office on Drugs and Crimes (UNODC) and Ministry of Social Justice and Empowerment, GOI 2004).
- Incidences of vagrancy, delinquency, alcoholism, drug addiction, truancy and crimes amongst adolescents have been sharply increasing. Boys outnumber girls and most of them are illiterates or have schooling of a few years ( 41 per cent primary education and 29 per cent illiterate) A large number of them are school dropouts (National Crime Records Bureau (NCRB) 2003)

is also associated with declining grades, absenteeism from school and dropping out of school. Drug abuse in adolescents has led to increase in the crime rate. Addicts resort to crime to pay for their drugs. Substance abuse can adversely affect an adolescent's psychological and social development.

### 13.4 PROTECTION OF NATURAL RESOURCES

The environment is a key determinant of social and individual health. You may be aware that many of our health problems are caused by environmental degradation. Exposure to air, water and soil pollution, chemicals in the environment, or noise, can cause cancer, respiratory, cardiovascular and communicable diseases, as well as some other serious health disorders. Although environmental degradation can affect the health of the whole population, some groups are particularly vulnerable, including children, pregnant women, the elderly and persons with pre-existing family history of certain diseases. Recall what you have learnt in the chapter on water management.

As you are aware that number of factors contribute to environmental degradation, but the most important factor is the misuse and over use of natural resources. All that the nature has provided to us such as soil, air, water, minerals, sunshine (sunlight), animals and plants, etc., are known as natural resources. Human beings use these directly or indirectly for their survival and welfare. The problem lies in how these natural resources are distributed and used. If at any time one person or a group of people uses more than their fair share of resources, an imbalance is created. This leads to environmental health problems for others.

It is, therefore, essential for every individual to ensure that natural resources are protected and are not misused or over used, so that social and individual health is not affected adversely. In India, we have had a great tradition of environmental conservation. We have been taught since ages to respect nature and to recognise that all forms of life — human, animal and plant are closely interrelated. Disturbance in one gives rise to an imbalance in others. Our Constitution also has provisions for protection of environment.

#### 13.4.1 Clean Water and Food Resources

In view of the above, all the natural resources need to be protected. It can be done in two ways. Efforts are needed to ensure that natural resources are used judiciously according to the needs of the present generation, and of future generations. Secondly, care needs to be taken so that natural resources are properly maintained and sustained. We may take the examples of water and food resources.

#### ACTIVITY 13.8

Design an advertisement for community members to say no to drug abuse. Discuss with classmates to make the message catching to more community members.

- Design parent-parent campaign for discouraging drug share.

#### ACTIVITY 13.9

- Survey the community around your school and prepare a report on what it is doing to healthy environment.
- Prepare a chart on 17 sustainable development goals.

#### ACTIVITY 13.10

Find out about a community which has a tradition of environment conservation. Write a brief report about their accomplishment. Share this with your classmates.

**Box 13.3**

There is a provision under Directive Principles of State Policy (article 48) that the “State shall endeavour to protect and improve the environment and to safeguard the forests and wildlife in the country”. Moreover, one of the Fundamental Duties provided in article 51 A(g) is “to protect and improve the natural environment including forests, lakes and rivers and wildlife and to have compassion for the living creatures”.

**Box 13.4**

In India, the green revolution has helped in growing food for a fast growing population. Over-exploitation of land and water resources and extensive use of fertilisers and pesticides became a major source of contamination of these natural resources.

With a view to protecting and conserving clean water the following steps are needed:

- growing vegetation in the catchment areas. This will hold water in the soil. It allows sea water to percolate into deeper layers and contribute to pool ground water;
- constructing dams and reservoirs to regulate supply of water to the fields as well as to enable generation of hydroelectricity.
- treated clear water of the sewage should be released into the rivers.
- industrial wastes (effluents) should not be released in rivers.
- judicious use of water in our day-to-day life. Rain water harvesting should be done by storing rain water to recharge ground water.
- fertilisers, pesticides and insecticides should be used only after getting the soil tested in nearby laboratory.
- community be made aware of proper use of fertilisers and pesticides.
- restriction needs to be imposed on the use of prime agricultural land for other purposes. The decision for land use should be based upon land capability and land productivity.
- there should be incentives for cultivation of crops with high nutritive value and those with lesser demands on water and energy inputs.
- local bodies like Zilla Parishads, Gram Panchayats and Samitis need to be strengthened to ensure effective decentralisation and optimal resource management.

**13.5 EDUCATION OF COMMUNITY**

The discussion on various aspects of social health leads us to realise that health is a complex issue which cannot be fully managed only by educating individuals. Community as a whole has a very important role to play in ensuring health of all individuals and for healthy living. In fact, education and promotion of healthy living and sustainable practices in the community enhance the quality of life for all. The community should be educated about living sustainable and healthy life styles. The one most common denominator in this regard may be what all we eat and what nutrition we all need to keep us healthy. It is the one common sustainable practice that applies to every single one of us, regardless of age, ethnicity, or economic situation. It is also most important to educate the community about sustainable and healthy living in a learning environment.

**ASSESSMENT****Answer the following questions**

1. What is the meaning of social health? How do social customs influence social health?
2. Examine the social customs in respect of early marriage, breastfeeding practices, family size and preference for male child.
3. What is substance abuse? How does it affect the social and individual health?
4. Why is the protection of natural resources important for social and individual health?
5. What do you mean by community education? Why is it important to educate the community for a healthy life?

© NCERT  
not to be republished



# Adolescent Friendly Health Services (AFHS)

14



13149CH14

## 14.1 INTRODUCTION

India is the second most populous country in the world with a total population of over 1.21 billion according to the 2011 Census. Adolescents (10–19 years) constitute over one-fifth of the total population, and their number is estimated to be about 243 million. They represent a resource for the future whose

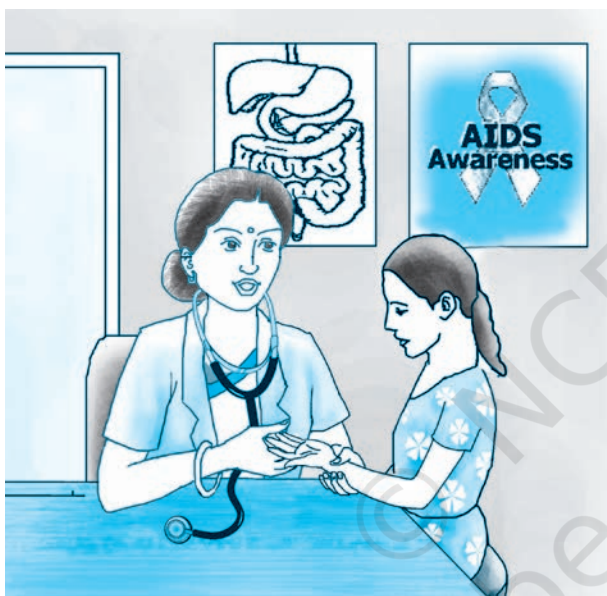

Fig. 14.1 : Visit to AFHS

potential needs to be nurtured in a positive manner. The adolescents are considered to be healthy as a group; however, they do have a range of health problems that cause a lot of morbidity as well as mortality. In spite of specific health problems, it is a common observation that the existing health services do not cater to the specific problems of adolescents. Moreover, it is a challenge for the health sector to respond to their needs adequately by offering services in a friendly manner in a non-threatening environment. In this chapter, an attempt has been made to discuss the health needs of adolescents, the status of existing adolescent friendly health services and the manner in which these services can be made available to adolescents so that these can be adequately utilised by them.

## 14.2 HEALTH NEEDS OF ADOLESCENTS

As you have realised while going through the chapters 'Growing up with Confidence' and 'Diet for Healthy Living', adolescence is the most significant period in the life of human beings. It is imperative, therefore, that the needs of adolescents be recognised and met adequately. Their health needs are mentioned below.

- (i) **Nutritional Needs:** as discussed in the previous chapters, many boys and girls enter adolescence undernourished, making them more vulnerable to diseases. The findings of the National Family Health Survey 3 (NFHS 3) indicate high percentage of anaemia (56 per cent of females and 25 per cent of males in 15–24 age group were anaemic). Anaemia affects physical

growth, cognitive development and performance in school and at work in later years. Anaemic women are more prone to give birth to malnourished children, with significant morbidity and mortality associated with both mother and child. Adequate nutrition and healthy eating habits and physical exercise at this age are foundations for good health in adulthood.

- (ii) Reproductive and Sexual Health Needs:** the adolescents confront a number of reproductive and sexual health problems. They hesitate to seek information from authentic sources as such issues are considered taboo in our society. There is always a possibility of their practising risky behaviour, thereby acquiring HIV and other sexually transmitted infections. According to National AIDS Control Organisation, almost 50 per cent of new HIV infections are taking place in 15–24 years age group (NACO 2005). The adolescent girls suffer due to a number of myths related to menstruation. Early marriage is still a serious problem in many parts of the country. A substantial number of adolescent girls, mostly married girls, become pregnant and give birth to children below the legal age of marriage which is 18 years. According to NFHS 3, twelve per cent of married young women aged 15–19 have become mothers and 4 per cent of women ages 15–19 are currently pregnant with their first child. This means that one in six women in the age group 15–19 years begun child bearing. This phenomenon of early pregnancy adversely affects the health of both mothers and children and is the cause of mortality and morbidity among them.

Sexual harassment in public places, institutions of education, in and around neighbourhood and at the workplace is a well established fact. Child abuse, bullying and ragging are also common, more so among boys.

- (iii) Mental Health Concerns:** it is estimated that at least 20 per cent of youth experience some form of mental problems such as depression, mood disturbances, substance abuse, suicidal behaviour, eating disorders, aggression, violence. Among 15–19 year olds, suicide is the second leading cause of death, followed by violence in the family and community. In fact, effective and sensitive care of adolescent victims of violence is needed as one of the priority measures.
- (iv) Substance Abuse:** tobacco and alcohol use among young people is emerging as a matter of concern. The projected number of drug abusers in India is about three

million, and most are in the age group of 16–35 years (UNODC, 2003). Nearly 11 per cent were introduced to cannabis before the age of 15 years and about 26 per cent between the age of 16–20 years (UNODC and Ministry of Social Justice and Empowerment, 2004). Findings of NFHS 3 show that in the age group of 15–19 years, 3.5 per cent women and 28.6 per cent men were using some kind of tobacco. Similarly, in this age group 1 per cent of women and 11 per cent of men were consuming alcohol. Further, 6.8 per cent women and 18.3 per cent men were drinking about once a week.

**(v) Accidental Injuries:** accidental injuries are a leading cause of death and disability in adolescents, of which road traffic injuries, drowning and burns are the most common. Injury rates among adolescents are the highest. Public education targeted at young people on how to avoid accidental injuries during driving and using road, drowning, burns and falls can reduce injuries.

In order to address the above needs, adolescent friendly health services have been developed. These adolescent friendly health services have been designed specifically to attract them, meet their needs conveniently and retain them for continuing care. We have to take note of an important fact that adolescents are not a homogeneous group. Their situation varies

with respect to age, sex, marital status, class, region and cultural context. This calls for interventions that are flexible and responsive to their needs.

### 14.3 ADOLESCENT FRIENDLY HEALTH SERVICES (AFHS): WHAT DOES THIS MEAN?

As we have seen, the health needs of young people are special in many respects. Therefore, there is a need to establish special services for them. These services are called “Adolescent Friendly Health Services” (AFHS). They have a specialised approach for giving adolescents preventive, promotive and curative health care. These services are mostly run by the government and in them diagnostic, treatment, counselling and other facilities related to health are offered for free or at a very minimal charge.

### 14.4 NEED FOR AFHS

Specialised services are needed for adolescents because they are still in the developmental stage. They have a lot of concerns,

#### ACTIVITY 14.1

Talk to your friends or classmates and make a report.

- if they are aware of adolescent friendly health services and if they have ever visited the place where such services are available.
- if they have visited, what has been their experience, and if they have not visited any, what are the reasons for not doing so.

apprehensions and lack of understanding regarding their own needs. The adolescents feel shy, embarrassed and hesitant in talking to adults, especially regarding matters that are personal. Most adolescents avoid seeking care and guidance. They feel more comfortable in discussing their problems and concerns with their peers who also do not have scientific knowledge. In view of this, separate adolescent friendly health services need to be provided. Such special clinics can take care of all the concerns of the adolescents in an ambience in which they can utilise services without any hesitation.

### 14.5 WHY DO ADOLESCENTS HESITATE IN UTILISING HEALTH SERVICES?

In addition to some of the reasons cited above, think of the reasons as to why the adolescents do not avail the health services. In fact, they face constraints in seeking services due to barriers such as:

- (i) Myths and misconceptions related to the development of sexual and reproductive organs.
- (ii) Lack of knowledge of the location of the health services or the kinds of services offered by them.
- (iii) Adolescents are not able to go to clinics as their timings do not match their schedule. They cannot miss school and college classes to visit these clinics.
- (iv) Lack of privacy and confidentiality in health clinics.
- (v) Long waiting period in the public health clinics.
- (vi) Cannot afford the fees of the private set up.
- (vii) No transport or means to go to these clinics, specially in rural areas. Moreover, they are unable to afford the cost of visiting these clinics.
- (viii) Negative attitudes or judgemental behaviour of nurse/doctor.
- (ix) The routine hospitals do not entertain adolescents coming alone, especially when they have issues regarding sexual and reproductive health. Most hospitals require the parent to accompany them and/or to give permission for any procedure or testing as per the legal requirement.

### 14.6 WHERE ARE AFHS LOCATED?

Adolescent Friendly Health Services are located at various places, in hospitals and health centres or at other places. There are three major models of the location of such services:

#### Fixed Site Models

1. Hospitals, both public and private in urban areas.
2. Clinics and Health centres in cities.

### ACTIVITY 14.2

Visit an Adolescent Friendly Health Service Centre. Discuss with the nurse/doctor the myths and misconceptions usually experienced by adolescents.

3. Primary Health Centres and other Rural Health Centres, specially under NRHM (National Rural Health Mission) by the Ministry of Health and Family Welfare, Government of India.

#### Outreach Models

1. School based or linked clinics
2. Workplace clinics
3. Satellite clinics
4. Mobile clinics
5. Departments associated with Ministry of Health and Family Welfare like National AIDS Control Organisation (NACO) and Ministry of Youth Affair and Sports like Nehru Yuva Kendra (NYK).

#### ACTIVITY 14.3

Find out the AFHS centres that are located near your school or home or in the district. Make a list of their addresses and contact numbers which can be useful to yourself and to your friends. Display this list on the board for the benefit of all.

#### Adolescent services can also be delivered by

1. Telephone helplines which have toll free (no charge) numbers
2. Call-in radio talks
3. Websites that answer questions by email and
4. Partnering with existing agencies that serve youth, like National Scout Association, (NSS) National Service Scheme, etc.

### 14.7 CHARACTERISTICS OF AFHS

#### 14.7.1 Role of the staff working in the AFHS

The Ministry of Health and Family Welfare (MoHFW), GOI, is making efforts to train the staff at health care centres to deal with adolescents. In case you or any of your friends has any problem or is concerned about any issue, you should visit the AFHS centre and discuss the same with the nurse or doctor available. The staff has now been adequately trained to handle adolescence issues through discussion and counselling. The staff of adolescent friendly health centres is expected to:

- **Show respect for adolescents:** the staff need to be non-judgmental and non-critical of the issues an adolescent comes to the clinic with, including issues regarding sexual and reproductive health.
- **Know importance of privacy and confidentiality:** the trained staff should provide privacy in physical examination without any embarrassment. The doctors, nurses and other staff should not divulge information about the adolescent patient to the parents or acquaintances, about what they came to the clinic for. They will need to tell parents only after informing the adolescent about the legal need or in view of protecting life and health of the adolescent.

#### Box 14.1

Visit a website [aeparc.org](http://aeparc.org) for information related to adolescence.



- **Spend adequate time and show lot of patience:** The staff needs to be trained to give adequate time to make the adolescent feel comfortable to discuss all issues related to puberty such as body image, relationships and sexuality.
- **Introduce adolescent to local peer educators:** Most young people prefer talking with their peers about their personal and sensitive issues. Hence, peer educators are also introduced to the adolescents.

### 14.8 SPECIAL SERVICES RENDERED TO ADOLESCENTS IN THE AFHS

Special services provided by the AFHS to adolescents are:

- monitoring growth and development of adolescent and providing the required information about changes;
- promoting healthy diet to prevent malnutrition and obesity;
- encouraging adolescents to take missed vaccine doses for immunisation;
- counsel them about the prevention of intentional injuries;
- advise them against substance abuse;
- counsel them on life skills related to sexual and reproductive health; and
- tell them about prevention of lifestyle diseases and other common diseases like STIs, AIDS, heart disease, diabetes and so on.

### 14.9 ADOLESCENTS OTHER THAN STUDENTS WHO MAY NEED AFHS

Being in school you will be able to get information about AFHS. But there are certain sections of adolescents in the society who are at a higher risk, need special care and are difficult to reach as they are not in schools.

**These special categories of adolescents include:**

1. Street youth
2. Adolescents working in shops and other establishments
3. Domestic help
4. Youth in foster care
5. Institutional inmates (in juvenile homes)
6. Youth with special needs.

Having understood the importance of AFHS, you should make efforts to make these adolescents aware of AFHS, and help them access these services.

AFHS are set up to meet the special needs of adolescents. You can go to the AFHS alone and receive services. Services are provided for you to understand all issues regarding

### ACTIVITY 14.4

One of your friends is showing signs of depression. she/he comes to you for help. You ask if she/he would like to go to AFHS for help. She/he is not willing to go to AFHS. How will you convince her/him to go to AFHS. Write three arguments or counselling points that help you to convince your friend to go to AFHS.

**ACTIVITY 14.5**

1. Visit the nearby AFHS with your teachers. Discuss with the Nurse/ Doctor the most common problems with which the adolescent boys and girls come to the centre.
2. Does the staff ensure that privacy and confidentiality of adolescents is maintained? Write your findings in your diary.
3. Talk with some of the youth attending the AFHS and find out how useful these services are ?

puberty, maturity growth and development, relationships, nutrition and matters related to reproductive health. You will be given all the necessary advice and treatment. The doctor will always respect your privacy and confidentiality. In certain situations where the parents need to be informed as per the requirement of the law or for your personal safety, the doctor will first inform you the need to tell the parents and then only, with your cooperation, inform your parents. One should not stigmatise a person going to an AFHS. In fact, he or she should be admired for awareness. Adolescents with special needs may seek guidance from a specialised centre which may not necessarily be only on sexual issues.



## ASSESSMENT

**Answer the following questions**

1. Why are special health services needed for adolescents? Give four reasons.
  - i. ....
  - ii. ....
  - iii. ....
  - iv. ....
2. What are the common barriers which prevent adolescents from using the health facilities?
3. Explain the various health needs of Adolescents.
4. “Reproductive and sexual health problems are the most difficult to share with the AFHS doctor.” Why? Give at least three reasons.
  - i. ....
  - ii. ....
  - iii. ....

**From Questions 4 to 7 tick (✓) the options which you feel are correct. You may tick more than one option.**

1. The adolescents do not go to hospital due to:
  - (a) lack of privacy.
  - (b) not sure of confidentiality.
  - (c) cannot afford fees.
  - (d) timings not suitable.
  - (e) don't feel comfortable.

2. An Ideal facility for AFHS should
  - (a) be away from the city.
  - (b) have convenient timings.
  - (c) maintain privacy and confidentiality.
  - (d) be near the villages.
3. The staff in AFHS should:
  - (a) be specially trained staff who are able to understand the adolescent issues.
  - (b) be non-judgmental.
  - (c) respect adolescents.
  - (d) have a lot of patience and time to understand the adolescent problems.
4. Special services delivered in AFHS are:
  - (a) sexual and reproductive health issues.
  - (b) nutrition counselling.
  - (c) treatment of cancer and acute diseases.
  - (d) prevention of substance abuse.
  - (e) eye operation.
  - (f) immunisation.
  - (g) specially challenged youth.
5. List the services which you would like to be addressed in the AFHS.
  - (a) .....
  - (b) .....
  - (c) .....

## FEEDBACK QUESTIONNAIRE

(Textbook on Health and Physical Education Guide for Class IX)

Please give your comments on the textbook by filling this feedback questionnaire. Please send the duly filled questionnaire to the undersigned, Department of Education in Social Sciences, NCERT, Sri Aurobindo Marg, New Delhi-110016.

While answering a question if you find the space inadequate, please attach a separate sheet. All questions are meant both for teachers and students. You can provide your feedback in English or Hindi. Even parents if desire can respond.

Teacher/Student/Parent

Name \_\_\_\_\_

School Address \_\_\_\_\_

\_\_\_\_\_

\_\_\_\_\_

1. Do you find the Textbook easy to understand? Yes/No
2. Point out chapters/pages where the language is difficult to understand.

Chapter No.	Page No.	Lines
_____	_____	_____
_____	_____	_____
_____	_____	_____

3. Do you think the content of the book is adequate to meet the requirements of the syllabus? Yes/No
4. (i) Point out chapters which are lengthy

\_\_\_\_\_

\_\_\_\_\_

(ii) Point out chapters which are too sketchy

\_\_\_\_\_

\_\_\_\_\_

5. Point out illustrations which are not helpful in understanding the content.

Page No.	Illustration	Caption
_____	_____	_____
_____	_____	_____
_____	_____	_____

6. (i) Certain practical activities and games have been suggested. How many activities and games have you undertaken in your class? Mention them.

\_\_\_\_\_

\_\_\_\_\_

- (ii) What difficulties did you face in organising these activities and games?

\_\_\_\_\_

\_\_\_\_\_

- (iii) Would you like to suggest any activity(ies). Mention these.

\_\_\_\_\_

\_\_\_\_\_

7. Certain questions have been given in boxes in the text of chapters.

- (i) Do you try to find out their answers? Yes/No

- (ii) Are these helpful in understanding the text of the chapter? Yes/No

- (iii) Do you find these questions interesting? Yes/No

8. (i) Do you find the exercises given at the end of each chapter in the textbook interesting? Yes/No

- (ii) Point out the exercises which according to you should be modified.

Page No.

Exercise No.

_____	_____
_____	_____
_____	_____

9. Point out the printing errors, if any.

Page/Para. No.

Error

_____	_____
_____	_____
_____	_____

10. Any specific comments / suggestions for overall improvement of the textbook.

\_\_\_\_\_

\_\_\_\_\_

\_\_\_\_\_



## NOTES

---

© NCERT  
not to be republished