

SCIENCE

Textbook for Class VIII

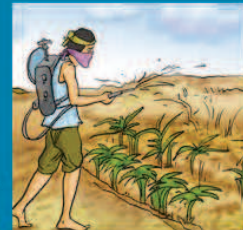
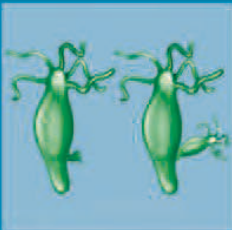
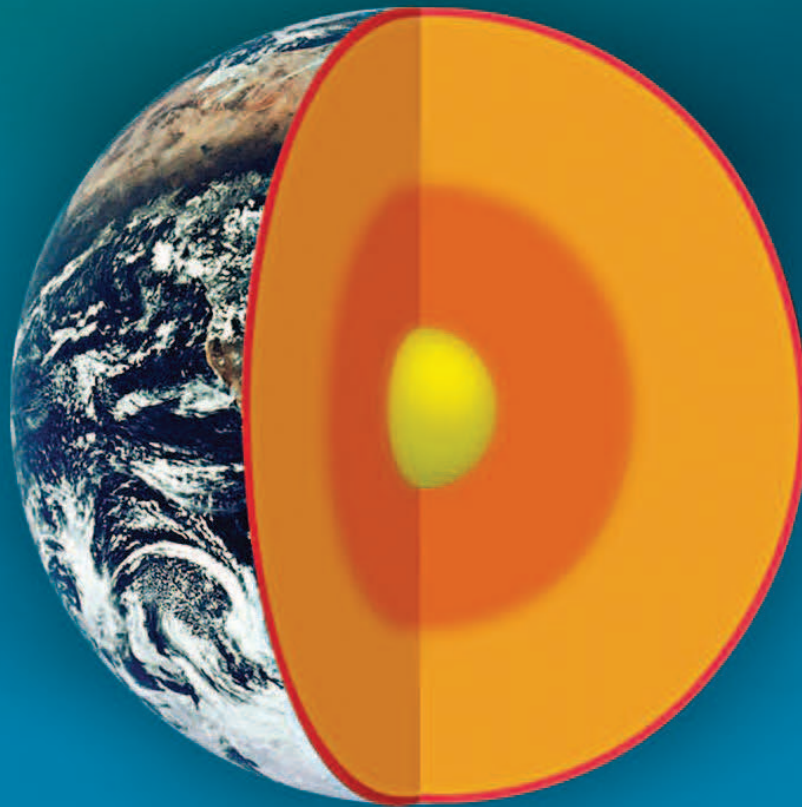

INDEX

A

Acid Rain	73, 241
Acrylic	34
Adam's Apple	116
Adolescence	120
Adrenalin	120
Agricultural Practices	1, 2
Air Pollution	240, 241
Algae	17-19
Amplitude	164, 165
Angle of Incidence	200
Angle of Reflection	200
Animal Husbandry	12
Antibiotics	20,21
Antibodies	21
Artificial Satellites	232
Artificial silk	33
Asexual Reproduction	100, 106, 107
Asteroids	231
Atmospheric pressure	140, 141
Atom	52
Audible	166

B

Bacteria	17-21
Balanced Diet	121
Ball Bearing	153
Binary Fission	108
Biodiversity	78, 79
Biosphere Reserve	79-81
Blind spot	206
Braille	209, 210
Budding	107

C

Calorific Value	72
Carrier	23
Cassiopeia	224
Celestial Objects	215, 216
Cell	90-96, 173
Cell Membrane	93, 94
Cell Wall	94
Chemical Contamination	247
Chloroplast	96
Chromosome	95
Coal	44, 45, 57, 59-61
Coal Gas	58
Coal Tar	58
Coke	58
Combustion	64, 65
Comets	231
Communicable Diseases	23
Conductor	45, 175, 176
Cones	206
Constellations	221-224
Contact Force	134, 135
Cornea	206
Crop	1-3, 10
Crust	192
Cytoplasm	94

D

Deforestation	74, 77, 78, 84
Desertification	78
Diffused/Irregular reflection	202
Discharge	188, 189
Dispersion	205

Displacement Reaction	50, 51	G	
Drag	153	Gene	95
Ductility	45	Global Warming	61, 73, 243
E		Good Conductor	45, 172, 173, 175, 176, 187
Eardrum	163, 164	Granaries	12
Earthquake	190-195	Gravitational Force	137
Earth's Plates	192, 193	Gravity	137
Ecosystem	83	Green House Effect	242
Eggs	90, 91, 102-106, 108, 116-118	H	
Electrode	176-178	Hardness	44
Electroplating	178, 179	Harvesting	10, 11
Electrostatic Force	136	Hertz (Hz)	164, 166
Elements	52	Hormones	117, 119, 120
Embryo	104	I	
Endangered Species	83	Ideal Fuel	72
Endemic Species	81	Ignition Temperature	67
Endocrine Glands	117	Incident Rays	199-201
Estrogen	117	Inflammable Substances	68
Eukaryotes	95	Insulin	120
Explosion	70	Interlocking	151
External Fertilisation	103	Internal Fertilisation	102
Extinct	83	Iris	206
F		Irrigation	7-9
Fauna	80, 81	K	
Fermentation	20	Kaleidoscope	204, 205
Fertilisation	102	Kharif	2
Fertiliser	5-7	L	
Fire Extinguisher	69	Lactobacillus	19
Flame	64, 65, 70-72	Larynx	160
Flora	80-82	Lateral Inversion	202
Fluid Friction	153	Laws of Reflection	199-201
Foetus	105	LED	174
Force	127-138, 141	Light Year	220
Fossil Fuel	57, 61	Lightning	184, 188, 189
Friction	146-153	Lightning Conductor	190
Fuel	64, 68, 69, 72, 73	Loudness	165
Fuel Efficiency	72	Lubricants	151, 152
Fungi	11, 17-19		

M

Magnetic Force	135
Malleability	45
Manure	5
Metalloids	52
Metals	44-46, 48-52
Metamorphosis	106
Meteorites	232
Meteors	232
Microorganism	17, 19-26
Migratory Birds	84
Multicellular	91
Muscular Force	134, 135

N

National Park	82, 83
Natural Gas	56, 57, 59-61
Negative Charge	187, 188
Nitrogen Cycle	27
Nitrogen Fixation	26
Noise	166, 167
Non-Contact Force	136
Non-Metals	44, 46-52
Nuclear Membrane	95
Nucleolus	95
Nucleus	94, 96
Nylon	33, 34

O

Orbit	217, 226
Organ	92, 93
Organelles	95
Orion	224
Oscillation	164
Oviparous Animals	105

P

Pasteurisation	26
Pathogen	23

Petroleum	56-61
Petroleum Refinery	60
Phases of Moon	216-218
Pitch	165, 166
Pituitary Gland	117
Planets	225-228, 230
Plasma membrane	93
Plastic	36-39
Plastid	96
Plough	3
Pole Star	221
Pollutants	240, 241, 243, 245
Polyester	34, 35
Polymer	33, 36
Polythene	34, 36
Poor Conductor	172, 175
Positive Charge	188
Potable Water	248
Preservation	25
Pressure	137-142
Prokaryotes	95
Protozoa	17
Pseudopodia	92
Puberty	113, 116, 117, 118
Pull	127-132
Pupil	206
Push	127-138

R

Rabi	2
Rayon	33
Red Data Book	84
Reflected Rays	199-201
Reflection	199-202
Reforestation	85
Regular Reflection	202
Remote Sensing	233
Reproductive Health	120
Retina	206
Rhizobium	26
Richter Scale	193, 194
Rolling Friction	152

S			
Sanctuary	78, 79, 82	Time Period	164
Secondary Sexual Characters	116	Tissue	92, 93
Seeds	4-6	Transfer of Charge	187
Seismograph	194	Tremor	193, 194
Sex Chromosomes	118	Tsunami	192
Sexual Reproduction	100	U	
Shooting Stars	232	Unicellular	91
Shrillness	165	Ursa Major	222-223
Silo	12	V	
Sliding Friction	152	Vaccine	21
Solar System	215, 224, 228	Vacuole	96
Sonorous	46	Vibration	158
Sowing	4, 5	Virus	17, 19, 23, 24
Sperms	101, 102	Viviparous Animals	105
Stars	219, 222	Voice Box	115, 160
Static Friction	149	W	
Storage	11, 12	Water Pollution	245
Synthetic Fibres	32, 33, 35, 36	Weedicide	10
T		Weeds	10
Target Site	117	White Blood Cell (WBC)	92
Terylene	34	Wind Pipe	160
Testosterone	117	Winnowing	11
Thermoplastics	37	Y	
Thermosetting Plastics	37	Yeast	20
Threshing	11	Z	
Thunder	189	Zygote	102
Thunderstorm	189, 190		
Thyroxine	119, 120		

SCIENCE

TEXTBOOK FOR CLASS VIII



0854



एन सी ई आर टी
NCERT

राष्ट्रीय शैक्षिक अनुसंधान और प्रशिक्षण परिषद्
NATIONAL COUNCIL OF EDUCATIONAL RESEARCH AND TRAINING

ISBN 978-81-7450-812-6

First Edition

January 2008 Magha 1929

Reprint Edition

December 2008 Pausa 1930

January 2010 Magha 1931

November 2010 Kartika 1932

January 2012 Magha 1933

November 2012 Kartika 1934

October 2013 Asvina 1935

December 2014 Pausa 1936

December 2015 Agrahayana 1937

February 2017 Magha 1938

December 2017 Agrahayana 1939

December 2018 Agrahayana 1940

August 2019 Bhadrapada 1941

PD 900T RPS

© **National Council of Educational
Research and Training, 2008**

₹ 65.00

Printed on 80 GSM paper with NCERT
watermark

Published at the Publication Division,
by the Secretary, National Council of
Educational Research and Training, Sri
Aurobindo Marg, New Delhi 110 016 and
printed at Chandra Prabhu Offset
Printing Works (P.) Ltd., C-40, Sector-8,
Noida - 201 301 (U.P.)

ALL RIGHTS RESERVED

- ❑ No part of this publication may be reproduced, stored in a retrieval system or transmitted, in any form or by any means, electronic, mechanical, photocopying, recording or otherwise without the prior permission of the publisher.
- ❑ This book is sold subject to the condition that it shall not, by way of trade, be lent, re-sold, hired out or otherwise disposed of without the publisher's consent, in any form of binding or cover other than that in which it is published.
- ❑ The correct price of this publication is the price printed on this page. Any revised price indicated by a rubber stamp or by a sticker or by any other means is incorrect and should be unacceptable.

**OFFICES OF THE PUBLICATION
DIVISION,, NCERT**

NCERT Campus
Sri Aurobindo Marg
New Delhi 110 016

Phone : 011-26562708

108, 100 Feet Road
Hosdakere Halli Extension
Banashankari III Stage
Bangaluru 560 085

Phone : 080-26725740

Navjivan Trust Building
P.O.Navjivan
Ahmedabad 380 014

Phone : 079-27541446

CWC Campus
Opp. Dhankal Bus Stop
Paninhati
Kolkata 700 114

Phone : 033-25530454

CWC Complex
Maligaon
Guwahati 781 021

Phone : 0361-2674869

Publication Team

Head, Publication Division : *M. Siraj Anwar*

Chief Editor : *Shveta Uppal*

Chief Production Officer : *Arun Chitkara*

Chief Business Manager : *Bibash Kumar Das*

Assistant Editor : *Shashi Chadha*

Assistant Production Officer : *Deepak Jaiswal*

Cover, Layout and Illustrations
Ashwani Tyagi

Foreword

The National Curriculum Framework (NCF), 2005, recommends that children's life at school must be linked to their life outside the school. This principle marks a departure from the legacy of bookish learning which continues to shape our system and causes a gap between the school, home and community. The syllabi and textbooks developed on the basis of NCF signify an attempt to implement this basic idea. They also attempt to discourage rote learning and the maintenance of sharp boundaries between different subject areas. We hope these measures will take us significantly further in the direction of a child-centred system of education outlined in the National Policy on Education (1986).

The success of this effort depends on the steps that school principals and teachers will take to encourage children to reflect on their own learning and to pursue imaginative activities and questions. We must recognise that, given space, time and freedom, children generate new knowledge by engaging with the information passed on to them by adults. Treating the prescribed textbook as the sole basis of examination is one of the key reasons why other resources and sites of learning are ignored. Inculcating creativity and initiative is possible if we perceive and treat children as participants in learning, not as receivers of a fixed body of knowledge.

These aims imply considerable change in school routines and mode of functioning. Flexibility in the daily time-table is as necessary as rigour in implementing the annual calendar so that the required number of teaching days are actually devoted to teaching. The methods used for teaching and evaluation will also determine how effective this textbook proves for making children's life at school a happy experience, rather than a source of stress or boredom. Syllabus designers have tried to address the problem of curricular burden by restructuring and reorienting knowledge at different stages with greater consideration for child psychology and the time available for teaching. The textbook attempts to enhance this endeavour by giving higher priority and space to opportunities for contemplation and wondering, discussion in small groups and activities requiring hands-on experience.

The National Council of Educational Research and Training (NCERT) appreciates the hard work done by the textbook development committee responsible for this book. We wish to thank the Chairperson of the advisory group in science and mathematics, Professor J.V. Narlikar and the Chief Advisor for this book, Professor V.B. Bhatia for guiding the work of this committee. Several teachers contributed to the development of this textbook. We are grateful to their principals for making this possible. We are indebted to the institutions and organisations which have generously permitted us to draw upon their resources, material and personnel. We are especially grateful to the members of the National Monitoring Committee, appointed by the Department of Secondary and Higher Education,

Ministry of Human Resource Development under the Chairpersonship of Professor Mrinal Miri and Professor G.P. Deshpande, for their valuable time and contribution.

As an organisation committed to systemic reform and continuous improvement in the quality of its products, NCERT welcomes comments and suggestions which will enable us to undertake further revision and refinement.

New Delhi
30 November 2007

Director
National Council of Educational
Research and Training

© NCERT
not to be republished

Preface

This book is the outcome of the efforts of the textbook development committee appointed by the NCERT. The committee met a few times to interact with one another to improve the draft. Then there was a review meeting in which many experts and practicing school teachers were invited to review the draft and suggest improvements.

By and large we have stuck to the format of the Class VII book. By now famous characters, Boojho and Paheli, have been used to make the text interactive. Attempt has been made to recall children's own experiences and build concepts around them. This is designed to connect science that they study in the school with their everyday life.

Many activities have been suggested to clarify concepts. Some of these activities are so simple that children can perform them on their own. The requirement of the apparatus required for the activities is minimal. We performed all the activities ourselves to ensure that there was no difficulty in performing them in the school situation. The activities should also help children in developing skills such as presentation of data in tabular and graphical forms, reasoning and drawing inference from the given data.

The language of the book has been kept as simple as possible. A large number of photographs, illustrations, cartoons, etc. have been included to make the book attractive. To help teachers evaluate children effectively, a large number of exercises have been given at the end of each chapter. The teachers are encouraged to frame additional exercises to test children's understanding. Some challenging exercises have also been devised for those children who would like to appear for the National Talent Search Examination conducted by the NCERT.

We are conscious of the fact that there is a paucity of additional reading material for children. We have tried to address this problem by providing **non-evaluative boxes**. These boxes, in light orange, contain additional information, anecdotes, stories, strange facts and other such interesting materials.

We all know that children are mischievous and playful by nature. Therefore, in order to prevent any untoward incident during the performance of the activities in the school or outside, necessary cautions, in magenta, have been inserted at various places in the book.

To prepare children to assume their roles as responsible citizens of tomorrow, attempt has been made to sensitise them to the issues concerning gender, religion, environment, health and hygiene, water scarcity and energy conservation. We have sought to weave into the text the value of cooperation and the importance of peer learning.

An important feature of the book is what we call **Extended Learning**. These are totally **non-evaluative**, and purely voluntary activities and projects. Some of the projects in this section have been designed to enhance children's interaction with the experts, teachers, even parents, and society at large. The children are required to collect information of various kinds and draw conclusions of their own.

My request to teachers and parents is to use the book in the spirit in which it has been written. Encourage children to perform activities and learn by doing, rather than by rote. You can supplement, or even replace, the activities given here. If you

feel that you have better alternatives, especially with your local/regional flavour, please write to us so that these activities could be used in the future editions of the book.

We have been able to include only a small subset of children's experiences. You have a better knowledge of their experiences because you are in touch with them. Use them to illustrate the concepts being taught. Above all, please do not stifle children's natural curiosity. Encourage them to ask questions, even if sometimes you feel uncomfortable. If you do not know the answer to a question on the spot, do not feel embarrassed. You can promise them to find the answer and deal with it later. Make a genuine attempt to get the answer from whatever resources are within your reach, such as senior school or college teachers, experts, libraries, internet etc. If, inspite of your efforts, you cannot get the answer to some question, you could write to NCERT.

I must thank the NCERT for enabling us to talk to children through the medium of this book. Every member of the NCERT has been courteous and helpful to us.

In the end, I must express my gratitude to the members of the Editing Team, who worked tirelessly to help me bring the book to the present form. If you and your students find this book useful and enjoy teaching/learning science through this book, the Editing Team and I shall consider ourselves well-rewarded.

V.B. BHATIA

Chief Advisor

Textbook Development Committee

Textbook Development Committee

CHAIRPERSON, ADVISORY GROUP FOR TEXTBOOKS IN SCIENCE AND MATHEMATICS

J.V. Narlikar, *Emeritus Professor*, Inter University Centre for Astronomy and Astrophysics (IUCCA), Ganeshkhind, Pune University, Pune

CHIEF ADVISOR

V.B. Bhatia, *Professor (Retd.) (Physics)*, Delhi University, Delhi

MEMBERS

Bharati Sarkar, *Reader (Retd.) (Zoology)*, Maitreyi College, Delhi University, Delhi

C. V. Shimray, *Lecturer*, Department of Education in Science and Mathematics, (DESM), NCERT, Sri Aurobindo Marg, New Delhi

Gagandeep Bajaj, *Lecturer*, Department of Education, SPM College, Delhi University, Delhi

H.C. Jain, *Principal, (Retd.)* Regional Institute of Education, Ajmer

Harsh Kumari, *Headmistress*, CIE Experimental Basic School, Department of Education, Delhi University, Delhi

J. S. Gill, *Professor (Retd.)*, DESM, NCERT, Sri Aurobindo Marg, New Delhi

Kanhiya Lal, *Principal (Retd.)*, Directorate of Education, Delhi

Lalita S. Kumar, *Reader (Chemistry)*, School of Sciences, Indira Gandhi National Open University (IGNOU), Maidan Garhi, New Delhi

P.C. Agarwal, *Reader*, Regional Institute of Education, Ajmer

P.S. Yadava, *Professor*, Department of Life Sciences, Manipur University, Imphal

Puranchand, *Professor and Joint Director (Retd.)*, Central Institute of Educational Technology (CIET), NCERT, Sri Aurobindo Marg, New Delhi

R. Joshi, *Lecturer (SG)*, DESM, NCERT, Sri Aurobindo Marg, New Delhi

Rachna Garg, *Lecturer*, Central Institute of Educational Technology (CIET), NCERT, Sri Aurobindo Marg, New Delhi

Rashmi Sharma, *Lecturer*, North-East Regional Institute of Education, Shillong

R.K. Parashar, *Reader*, Regional Institute of Education, Bhubaneswar

Ruchi Verma, *Lecturer*, DESM, NCERT, Sri Aurobindo Marg, New Delhi

Shashi Prabha, *Lecturer*, DESM, NCERT, Sri Aurobindo Marg, New Delhi

Sunila Masih, *Teacher*, Mitra GHS School, Suhagpur, P.O. Hoshangabad, Madhya Pradesh

MEMBER-COORDINATOR

R. S. Sindhu, *Professor*, DESM, NCERT, Sri Aurobindo Marg, New Delhi

Acknowledgements

The National Council of Educational Research and Training (NCERT) acknowledges the valuable contribution of the individuals and organisations involved in the development of this book. The Council acknowledges the valuable contribution of the following academics for reviewing and refining the manuscript of this book: K.C. Sharma, *Reader (Physics)*, Regional Institute of Education, Ajmer; Charu Verma, *Lecturer (Science)*, DIET, Pitampura, Delhi; Geeta Bajaj, *TGT (Science)*, K.V. No. 3, Delhi Cantt., New Delhi; K.D. Sharma, *TGT (Science)*, R.P.V.V. Civil Lines, Delhi; Manohar Lal Patel, *Teacher*, Govt. R.N.A. Higher Secondary School, Pipariya, Madhya Pradesh; Reeta Sharma, *Reader (Botany)*, Regional Institute of Education, Bhopal; Kamal Deep Peter, OEI, Oracle India, Bangalore; Puneeta Sharma, *TGT (Science)*, L.D. Jain Girls Senior Secondary School, Sadar Bazar, Delhi; M.C. Das, *Teacher (Science)*, Govt. Secondary School, Zoom, West Sikkim; Deepti Kohli, P.D. Public School, Shalimar Bagh, Delhi; Sulekha Chandra, *Reader (Chemistry)*, Zakir Husain College, Delhi University, Delhi; R.S. Tomar, *TGT (Science)*, J.N.V. Mothuka, Faridabad (Haryana); Anjali Khirwadkar, *Lecturer*, Department of Education, M.S. University, Baroda (Gujrat); Suresh Chand, *TGT (Science)*, J.N.V. Ghaziabad Uttar Pradesh; Satheesh H.L., *TGT (Science)*, Demonstration School, Regional Institute of Education, Mysore; Simminder Kaur Thukral, NIIT, Kalkaji, New Delhi; M.M. Kapoor, *Professor (Retd.) (Chemistry)*, Delhi University, Delhi; Sarita Kumar, *Reader (Zoology)*, Acharya Narendra Dev College, Delhi University, Delhi. The contributions of Pushplata Verma, R.R. Koireng, Pramila Tanvar and Ashish K. Srivastava, *Assistant Professors*, are acknowledged for being a part of the review of this textbook.

The Council gratefully acknowledges the valuable suggestions received from the National Monitoring Committee in the development of the manuscript of this textbook.

The dynamic leadership of Professor Hukum Singh, Head, DESM, for providing guidance at different stages of development of the textbook and extending infrastructure facilities is highly acknowledged. Special thanks are due to Shveta Uppal, *Chief Editor* and Shashi Chadha, *Assistant Editor* for going through the manuscript and suggesting relevant changes.

The Council also acknowledges the efforts of Deepak Kapoor, *Incharge Computer Station*, Inder Kumar, *DTP Operator*; K.T. Chitrlekha, *Copy Editor* and Ritu Jha, *Proof Reader*.

The contributions of APC-office, administration of DESM, Publication Department and Secretariat of NCERT is also acknowledged.

A Note for the Students

The team of Paheli and Boojho will be with you as you journey through this textbook. They love to ask questions. All kinds of questions come to their minds and they collect them in their sacks. Sometimes, they may share some of the questions with you, as you read through the chapters.

Paheli and Boojho are also on the lookout for answers to many questions — sometimes the questions seem answered after they discuss them with each other, sometimes through discussions with other classmates, teachers or their parents. Answers to some questions do not seem available even after all these. They might need to experiment on their own, read books in the library, send questions to scientists. Just dig and dig and dig into all possibilities and see if the questions can be answered. Perhaps, they would carry some of the unanswered questions in their sacks to higher classes.

What will really thrill them would be your adding questions to their sacks or answers to their questions. Sometimes, activities are suggested in the textbook, results or findings of these by different groups of students would be of interest to other students and teachers. You can complete the suggested activities and send your results or findings to Paheli and Boojho. Do keep in mind that activities that involve using blades, scissors or fire need to be done strictly under the care of your teachers. Stick to the precautions given and then enjoy doing all the suggested activities. Mind, the book will not be able to help you much, if the activities are not completed!

We would like to advise you that you must make observations yourself and record whatever results you get. Keen and true observations are necessary for exploring any subject of study. For some reason your results may turn out to be different from those of your classmates. Do not worry. Try to find out the reason for these results instead of disregarding them. Do not ever copy results from your classmate.

You can send your feedback for Paheli and Boojho at:



To

The Head
Department of Education in
Science and Mathematics,
NCERT, Sri Aurobindo Marg,
New Delhi 110016

THE CONSTITUTION OF INDIA

PREAMBLE

WE, THE PEOPLE OF INDIA, having solemnly resolved to constitute India into a ¹**[SOVEREIGN SOCIALIST SECULAR DEMOCRATIC REPUBLIC]** and to secure to all its citizens :

JUSTICE, social, economic and political;

LIBERTY of thought, expression, belief, faith and worship;

EQUALITY of status and of opportunity; and to promote among them all

FRATERNITY assuring the dignity of the individual and the ²[unity and integrity of the Nation];

IN OUR CONSTITUENT ASSEMBLY this twenty-sixth day of November, 1949 do **HEREBY ADOPT, ENACT AND GIVE TO OURSELVES THIS CONSTITUTION.**

1. Subs. by the Constitution (Forty-second Amendment) Act, 1976, Sec.2, for "Sovereign Democratic Republic" (w.e.f. 3.1.1977)
2. Subs. by the Constitution (Forty-second Amendment) Act, 1976, Sec.2, for "Unity of the Nation" (w.e.f. 3.1.1977)

CONTENTS

FOREWORD	iii
PREFACE	v
Chapter 1	
CROP PRODUCTION AND MANAGEMENT	1
Chapter 2	
MICROORGANISMS : FRIEND AND FOE	17
Chapter 3	
SYNTHETIC FIBRES AND PLASTICS	32
Chapter 4	
MATERIALS : METALS AND NON-METALS	44
Chapter 5	
COAL AND PETROLEUM	56
Chapter 6	
COMBUSTION AND FLAME	64
Chapter 7	
CONSERVATION OF PLANTS AND ANIMALS	77
Chapter 8	
CELL — STRUCTURE AND FUNCTIONS	90
Chapter 9	
REPRODUCTION IN ANIMALS	100
Chapter 10	
REACHING THE AGE OF ADOLESCENCE	113

CONTENTS

Chapter 11		
FORCE AND PRESSURE		127
Chapter 12		
FRICTION		146
Chapter 13		
SOUND		157
Chapter 14		
CHEMICAL EFFECTS OF ELECTRIC CURRENT		172
Chapter 15		
SOME NATURAL PHENOMENA		184
Chapter 16		
LIGHT		199
Chapter 17		
STARS AND THE SOLAR SYSTEM		215
Chapter 18		
POLLUTION OF AIR AND WATER		239
INDEX		253



Paheli and Boojho went to their uncle's house during the summer vacation. Their uncle is a farmer. One day they saw some tools like *khurpi*, sickle, shovel, plough, etc., in the field.



I want to know where and how we use these tools.

You have learnt that all living organisms require food. Plants can make their food themselves. Can you recall how green plants synthesise their own food? Animals including humans can not make their own food. So, where do animals get their food from?

But, first of all why do we have to eat food?

You already know that energy from the food is utilised by organisms for carrying out their various body functions, such as digestion, respiration and excretion. We get our food from plants, or animals, or both.



Since we all need food, how can we provide food to a large number of people in our country?

Food has to be produced on a large scale.



In order to provide food for a large population—regular production, proper management and distribution is necessary.

1.1 Agricultural Practices

Till 10,000 B.C.E. people were nomadic. They were wandering in groups from place to place in search of food and shelter. They ate raw fruits and vegetables and started hunting animals for food. Later, they could cultivate land and produce rice, wheat and other food crops. Thus, was born 'Agriculture'.

When plants of the same kind are cultivated at one place on a large scale, it is called a **crop**. For example, crop of wheat means that all the plants grown in a field are that of wheat.

You already know that crops are of different types like cereals, vegetables and fruits. These can be classified on the basis of the season in which they grow.

India is a vast country. The climatic conditions like temperature, humidity and rainfall vary from one region to another. Accordingly, there is a rich

variety of crops grown in different parts of the country. Despite this diversity, two broad cropping patterns can be identified. These are:

(i) Kharif Crops : The crops which are sown in the rainy season are called kharif crops. The rainy season in India is generally from June to September. Paddy, maize, soyabean, groundnut and cotton are kharif crops.

(ii) Rabi Crops : The crops grown in the winter season (October to March) are called rabi crops. Examples of rabi crops are wheat, gram, pea, mustard and linseed.

Besides these, pulses and vegetables are grown during summer at many places.

1.2 Basic Practices of Crop Production



Why paddy can not be grown in the winter season?



Paddy requires a lot of water. Therefore, it is grown only in the rainy season.

Cultivation of crops involves several activities undertaken by farmers over a period of time. You may find that these activities are similar to those carried out by a gardener or even by you when you grow ornamental plants in your house. These activities or tasks are referred

to as **agricultural practices** which are listed below:

- (i) Preparation of soil
- (ii) Sowing
- (iii) Adding manure and fertilisers
- (iv) Irrigation
- (v) Protecting from weeds
- (vi) Harvesting
- (vii) Storage

1.3 Preparation of Soil

The preparation of soil is the first step before growing a crop. One of the most important tasks in agriculture is to turn the soil and loosen it. This allows the roots to penetrate deep into the soil. The loose soil allows the roots to breathe easily even when they go deep into the soil. Why does the loosening of soil allow the roots to breathe easily?

The loosened soil helps in the growth of earthworms and microbes present in the soil. These organisms are friends of the farmer since they further turn and loosen the soil and add humus to it. But why the soil needs to be turned and loosened?

You have learnt in the previous classes that soil contains minerals, water, air and some living organisms. In addition, dead plants and animals get decomposed by soil organisms. In this way, various nutrients in the dead organisms are released back into the soil. These nutrients are again absorbed by plants.

Since only a few centimetres of the top layer of soil supports plant growth, turning and loosening of soil brings the nutrient-rich soil to the top so that plants can use these nutrients. Thus,

turning and loosening of soil is very important for cultivation of crops.

The process of loosening and turning of the soil is called **tilling** or **ploughing**. This is done by using a plough. Ploughs are made of wood or iron. If the soil is very dry, it may need watering before ploughing. The ploughed field may have big clumps of soil called crumbs. It is necessary to break these crumbs. Levelling the field is beneficial for sowing as well as for irrigation. Levelling of soil is done with the help of a leveller.

Sometimes, manure is added to the soil before tilling. This helps in proper mixing of manure with soil. The soil is moistened before sowing.

Agricultural Implements

Before sowing the seeds, it is necessary to break soil clumps to get better yield. This is done with the help of various tools. The main tools used for this purpose are the plough, hoe and cultivator.

Plough : This is being used since ancient times for tilling the soil, adding fertilisers to the crop, removing the weeds and turning the soil. This is made of wood and is drawn by a pair of bulls or other animals (horses and camels). It contains a strong triangular iron strip called ploughshare. The main part of the plough is a long log of wood which is called a ploughshaft. There is a handle at one end of the shaft. The other end is attached to a beam which is placed on the bulls' necks. One pair of bulls and a man can easily operate the plough [Fig. 1.1 (a)].

The indigenous wooden plough is increasingly being replaced by iron ploughs nowadays.

Hoe : It is a simple tool which is used for removing weeds and for loosening the soil. It has a long rod of wood or iron. A strong, broad and bent plate of iron is fixed to one of its ends and

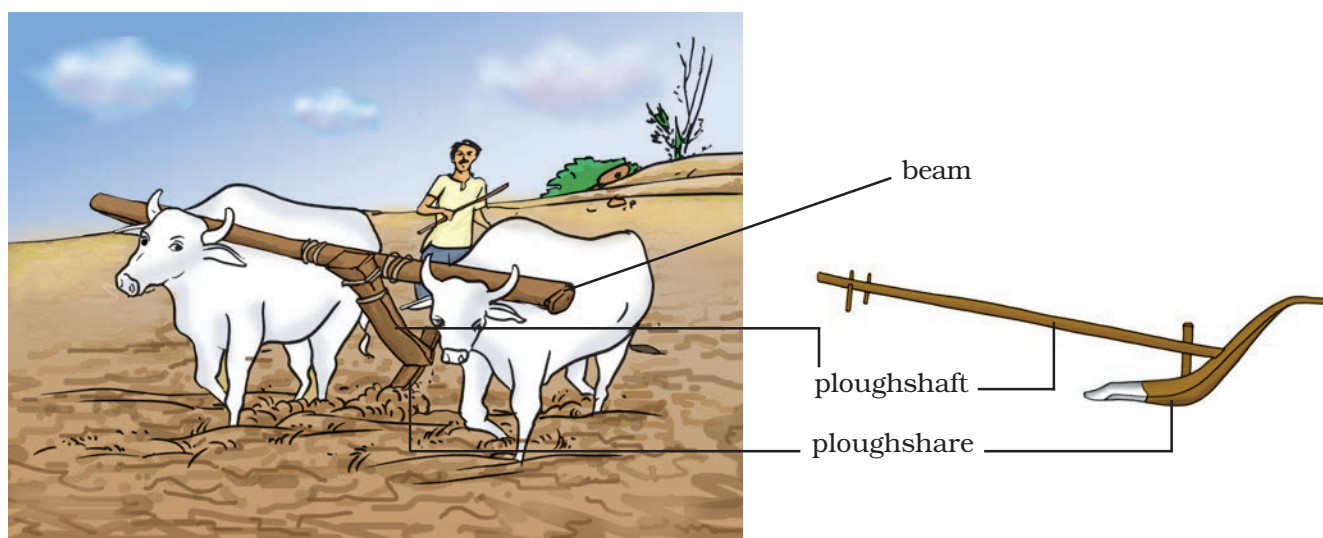

Fig. 1.1 (a) : The plough

works like a blade. It is pulled by animals [Fig. 1.1 (b)].

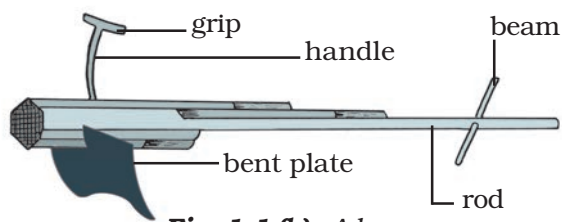

Fig. 1.1 (b) : A hoe

Cultivator : Nowadays ploughing is done by tractor-driven cultivator. The use of cultivator saves labour and time. [Fig. 1.1 (c)].



Fig. 1.1 (c) : Cultivator driven by a tractor

1.4 Sowing

Sowing is an important part of crop production. Before sowing, good quality, clean and healthy seeds of a good variety—are selected. Farmers prefer to use seeds which give high yield.

Selection of Seeds



One day I saw my mother put some gram seeds in a vessel and pour some water on them. After a few minutes some seeds started to float on top. I wonder why some seeds float on water!

Activity 1.1

Take a beaker and fill half of it with water. Put a handful of wheat seeds and stir well. Wait for some time.

Are there seeds which float on water? Would those be lighter or heavier than those which sink? Why would they be lighter? Damaged seeds become hollow and are thus lighter. Therefore, they float on water.

This is a good method for separating good, healthy seeds from the damaged ones.

Before sowing, one of the important tasks is to know about the tools used for sowing seeds [Fig. 1.2 (a), (b)].

Traditional tool : The tool used traditionally for sowing seeds is shaped like a funnel [Fig. 1.2 (a)]. The seeds are filled into the funnel, passed down through two or three pipes having sharp ends. These ends pierce into the soil and place seeds there.



Fig. 1.2 (a) : Traditional method of sowing

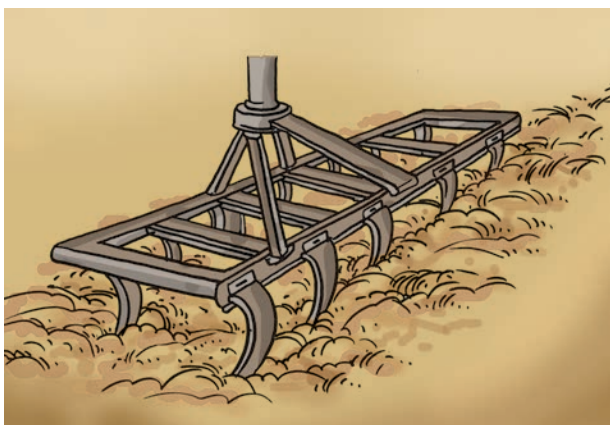

Fig. 1.2 (b) : A seed drill

Seed drill : Nowadays the seed drill [Fig. 1.2 (b)] is used for sowing with the help of tractors. This sows the seeds uniformly at equal distance and depth. It ensures that seeds get covered by the soil after sowing. This protects seeds from being eaten by birds. Sowing by using a seed drill saves time and labour.

There is a nursery near my school. I found that little plants were kept in small bags. Why are they kept like this?



Seeds of a few plants such as paddy are first grown in a nursery. When they grow into seedlings, they are transplanted to the field manually. Some forest plants and flowering plants are also grown in the nursery.

Appropriate distance between the seeds is necessary to avoid overcrowding of plants. This allows plants to get

sufficient sunlight, nutrients and water from the soil. At times a few plants may have to be removed to prevent overcrowding.

1.5 Adding Manure and Fertilisers

The substances which are added to the soil in the form of nutrients for the healthy growth of plants are called **manure** and **fertilisers**.

I saw a healthy crop growing in a farm. In the neighbouring farm, the plants were weak. Why do some plants grow better than others?



Soil supplies mineral nutrients to the crop plants. These nutrients are essential for the growth of plants. In certain areas, farmers grow crop after crop in the same field. The field is never left uncultivated or fallow. Imagine what happens to the nutrients?

Continuous cultivation of crops makes the soil poor in nutrients. Therefore, farmers have to add manure to the fields to replenish the soil with nutrients. This process is called manuring. Improper or insufficient manuring results in weak plants.

Manure is an organic substance obtained from the decomposition of plant or animal wastes. Farmers dump plant and animal waste in pits at open places and allow it to decompose. The decomposition is caused by some microorganisms. The decomposed matter is used as organic manure. You have already learnt about vermicomposting in Class VI.

Activity 1.2

Take *moong* or gram seeds and germinate them. Select three equal sized seedlings. Take three empty glasses or similar vessels. Mark them A, B and C. To glass A add little amount of soil mixed with a little cow dung manure. In glass B put the same amount of soil mixed with a little urea. Take the same amount of soil in glass C without adding anything [Fig. 1.3(a)]. Now pour the same amount of water in each glass and plant the seedlings in them. Keep them in a safe place and water them daily. After 7 to 10 days observe their growth [Fig. 1.3(b)].



Fig. 1.3 (a) : Preparation of the experiment

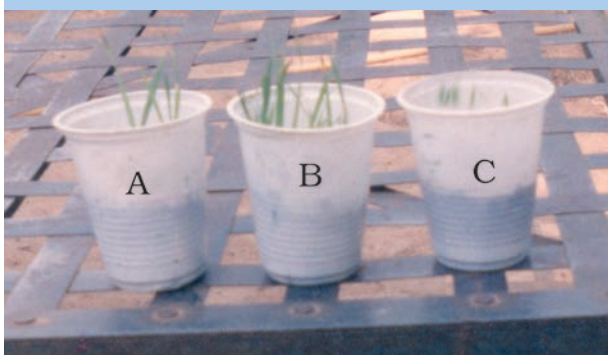

Fig. 1.3 (b) : Growing seedlings with manure and fertiliser

Did plants in all the glasses grow at the same pace? Which glass showed

better growth of plants? In which glass was the growth fastest?

Fertilisers are chemicals which are rich in a particular nutrient. How are they different from manure? Fertilisers are produced in factories. Some examples of fertilisers are— urea, ammonium sulphate, super phosphate, potash, NPK (Nitrogen, Phosphorus, Potassium).

The use of fertilisers has helped farmers to get better yield of crops such as wheat, paddy and maize. But excessive use of fertilisers has made the soil less fertile. Fertilisers have also become a source of water pollution. Therefore, in order to maintain the fertility of the soil, we have to substitute fertilisers with organic manure or leave the field uncultivated (fallow) in between two crops.

The use of manure improves soil texture as well as its water retaining capacity. It replenishes the soil with nutrients.

Another method of replenishing the soil with nutrients is through **crop rotation**. This can be done by growing different crops alternately. Earlier, farmers in northern India used to grow legumes as fodder in one season and wheat in the next season. This helped in the replenishment of the soil with nitrogen. Farmers are being encouraged to adopt this practice.

In the previous classes, you have learnt about *Rhizobium* bacteria. These are present in the nodules of roots of leguminous plants. They fix atmospheric nitrogen.

Table 1.1 : Differences between Fertiliser and Manure

S. No.	Fertiliser	Manure
1.	Fertiliser is a man-made inorganic salt.	Manure is a natural substance obtained by the decomposition of cattle dung and plant residues.
2.	Fertiliser is prepared in factories.	Manure can be prepared in the fields.
3.	Fertiliser does not provide any humus to the soil.	Manure provides a lot of humus to the soil.
4.	Fertilisers are very rich in plant nutrients like nitrogen, phosphorus and potassium.	Manure is relatively less rich in plant nutrients.

Table 1.1 gives the differences between a fertiliser and manure.

Advantages of Manure : The organic manure is considered better than fertilisers. This is because

- it enhances the water holding capacity of the soil.
- it makes the soil porous due to which exchange of gases becomes easy.
- it increases the number of friendly microbes.
- it improves the texture of the soil.

1.6 Irrigation

All living beings need water to live. Water is important for proper growth and development. Water is absorbed by the plant roots. Along with water, minerals and fertilisers are also absorbed. Plants contain nearly 90% water. Water is essential because germination of seeds does not take place under dry conditions. Nutrients dissolved in water are transported to each part of the plant. Water also

protects the crop from both frost and hot air currents. To maintain the moisture of the soil for healthy crop growth, fields have to be watered regularly.

The supply of water to crops at regular intervals is called **irrigation**. The time and frequency of irrigation varies from crop to crop, soil to soil and season to season. In summer, the frequency of watering is higher. Why is it so? Could it be due to the increased rate of evaporation of water from the soil and the leaves?



I am very careful this year about watering the plants. Last summer my plants dried up and died.

Sources of irrigation : The sources of water for irrigation are— wells, tubewells, ponds, lakes, rivers, dams and canals.



Fig. 1.4 (a) : Moat

Traditional Methods of Irrigation

The water available in wells, lakes and canals is lifted up by different methods in different regions, for taking it to the fields.

Cattle or human labour is used in these methods. So these methods are cheaper, but less efficient. The various traditional ways are:

- (i) moat (pulley-system)
- (ii) chain pump

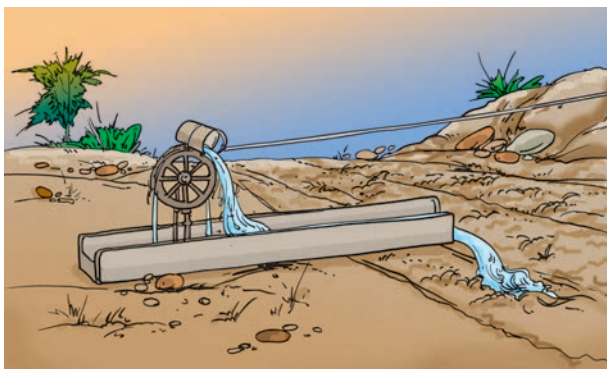

Fig. 1.4 (b) : Chain pump



Fig. 1.4 (c) : Dhekli

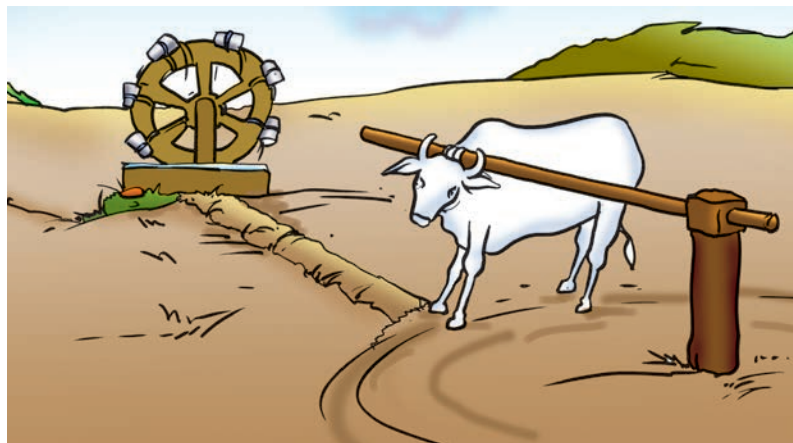

Fig. 1.4 (d) : Rahat

- (iii) *dhekli*, and
 - (iv) *rahat* (Lever system)
- [Figs. 1.4 (a)- (d)].

Pumps are commonly used for lifting water. Diesel, biogas, electricity and solar energy is used to run these pumps.

Modern Methods of Irrigation

Modern methods of irrigation help us to use water economically. The main methods used are as follows:

(i) Sprinkler System: This system is more useful on the uneven land where sufficient water is not available. The perpendicular pipes, having rotating nozzles on top, are joined to the main pipeline at regular intervals. When water is allowed to flow through the main pipe under pressure with the help of a pump, it escapes from the rotating nozzles. It gets sprinkled on the crop as if it is raining. Sprinkler is very useful for lawns, coffee plantation and several other crops [Fig. 1.5 (a)].

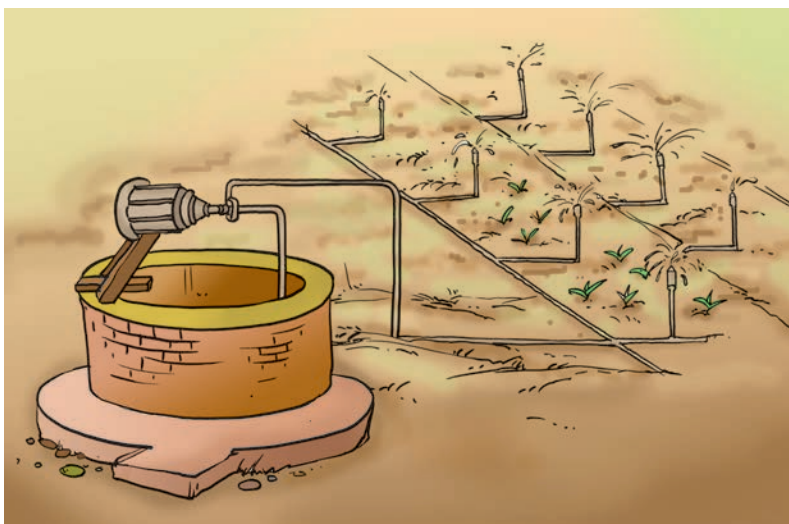

Fig. 1.5 (a) : Sprinkler system

(ii) Drip system : In this system, the water falls drop by drop directly near the roots. So it is called drip system. It is the best technique for watering fruit plants, gardens and trees [Fig. 1.5(b)]. Water is not wasted at all. It is a boon in regions where availability of water is poor.

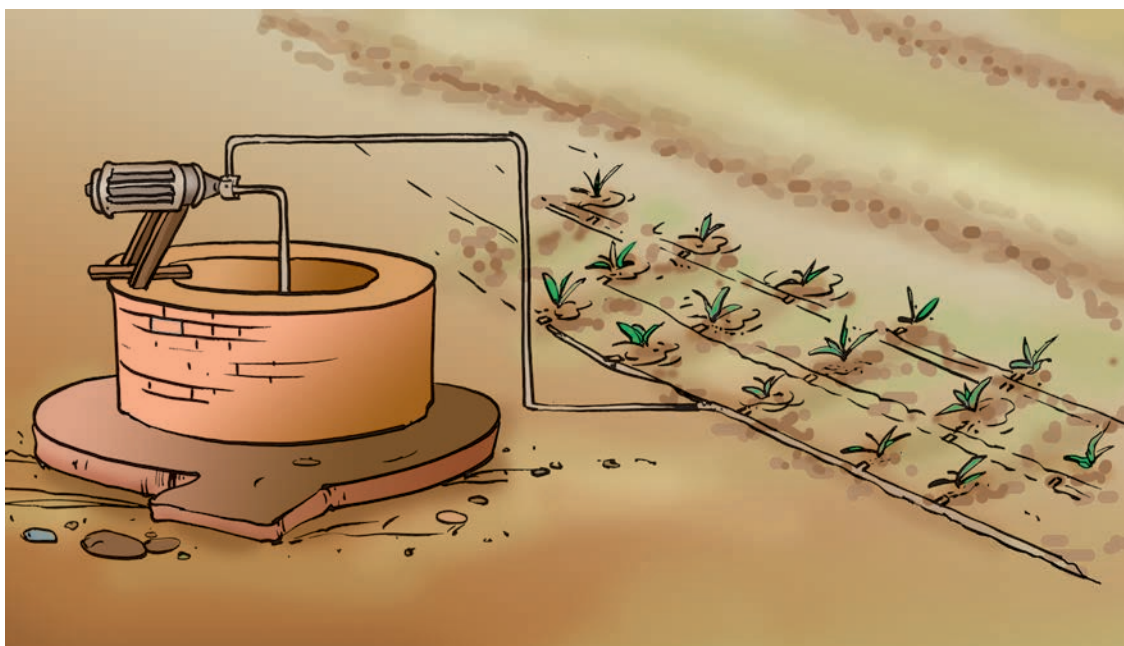

Fig. 1.5 (b) : Drip System

1.7 Protection from Weeds

Boojho and Paheli went to a nearby wheat field and saw that there were some other plants in the field, growing along with wheat plants.

Have these other plants been planted purposely?



In a field many other undesirable plants may grow naturally along with the crop. These undesirable plants are called **weeds**.

The removal of weeds is called weeding. Weeding is necessary since weeds compete with the crop plants for water, nutrients, space and light. Thus, they affect the growth of the crop. Some weeds interfere even in harvesting and may be poisonous for animals and human beings.

Farmers adopt many ways to remove weeds and control their growth. Tilling before sowing of crops helps in uprooting and killing of weeds, which may then dry up and get mixed with the soil. The best time for the removal of weeds is before they produce flowers and seeds. The manual removal includes physical removal of weeds by uprooting or cutting them close to the ground, from time to time. This is done with the help of a *khurpi*. A seed drill [Fig. 1.2(b)] is also used to uproot weeds.

Weeds are also controlled by using certain chemicals, called **weedicides**, like 2,4-D. These are sprayed in the fields to kill the weeds. They do not damage the crops. The weedicides are diluted with water to the extent required and sprayed in the fields with a sprayer. (Fig. 1.6).



Fig. 1.6 : Spraying weedicide

Do weedicides have any effect on the person handling the weedicide sprayer?



As already mentioned, the weedicides are sprayed during the vegetative growth of weeds before flowering and seed formation. Spraying of weedicides may affect the health of farmers. So they should use these chemicals very carefully. They should cover their nose and mouth with a piece of cloth during spraying of these chemicals.

1.8 Harvesting

Harvesting of a crop is an important task. The cutting of crop after it is mature is called **harvesting**. In harvesting, crops are pulled out or cut close to the ground. It usually takes 3 to 4 months for a cereal crop to mature.

Harvesting in our country is either done manually by sickle (Fig. 1.7) or by a machine called harvester. In the harvested crop, the grain seeds need to be separated



Fig. 1.7 : Sickle

from the chaff. This process is called **threshing**. This is carried out with the help of a machine called 'combine' which is in fact a harvester as well as a thresher (Fig. 1.8).



Fig. 1.8 : Combine



After harvesting, sometimes stubs are left in the field, which are burnt by farmers. Paheli is worried. She knows that it causes pollution. It may also catch fire and damage the crops lying in the fields.

Farmers with small holdings of land do the separation of grain and chaff by **winnowing** (Fig. 1.9). You have already studied this in Class VI.



Fig. 1.9 : Winnowing machine

Harvest Festivals

After three or four months of hard work there comes the day of the harvest. The sight of golden fields of standing crop, laden with grain, fills the hearts of farmers with joy and a sense of well-being. The efforts of the past season have borne fruit and it is time to relax and enjoy a little. The period of harvest is, thus, of great joy and happiness in all parts of India. Men and women celebrate it with great enthusiasm. Special festivals associated with the harvest season are Pongal, Baisakhi, Holi, Diwali, Nabanya and Bihu.

1.9 Storage

Storage of produce is an important task. If the harvested grains are to be kept for longer time, they should be safe from moisture, insects, rats and microorganisms. Harvested grains have more moisture. If freshly harvested grains (seeds) are stored without drying, they may get spoilt or attacked by organisms, making them unfit for use or for germination. Hence, before storing them, the grains are properly dried in the sun to reduce the moisture in them. This prevents the attack by insect pests, bacteria and fungi.



I saw my mother putting some dried neem leaves in an iron drum containing wheat. I wonder why?



Fig. 1.10 (a) : Silos for storage of grains



Fig. 1.10 (b) : Storage of grains in gunny bags in granaries

Farmers store grains in jute bags or metallic bins. However, large scale storage of grains is done in **silos** and **granaries** to protect them from pests like rats and insects [Fig. 1.10 (a) and (b)].

Dried neem leaves are used for storing food grains at home. For storing large quantities of grains in big godowns, specific chemical treatments are required to protect them from pests and microorganisms.

1.10 Food from Animals

Activity 1.3

Make the following Table in your note book and complete it.

S.No.	Food	Sources
1.	Milk	Cow, Buffalo, She-goat, She-camel . . .
2.		
3.		
4.		

After completing this Table, you must have seen that, like plants, animals also provide us with different kinds of food. Many people living in the coastal areas consume fish as a major part of their diet. In the previous classes you have learnt about the food that we obtain from plants. We have just seen that the process of crop production involves a number of steps like selection of seeds, sowing, etc. Similarly, animals reared at home or in farms, have to be provided with proper food, shelter and care. When this is done on a large scale, it is called **animal husbandry**.



Fish is good for health.
We get cod liver oil from fish
which is rich in vitamin D.

KEYWORDS

AGRICULTURAL
PRACTICES

ANIMAL HUSBANDRY

CROP

FERTILISER

GRANARIES

HARVESTING

IRRIGATION

KHARIF

MANURE

PLOUGH

RABI

SEEDS

SILO

SOWING

STORAGE

THRESHING

WEEDS

WEEDICIDE

WINNOWING

WHAT YOU HAVE LEARNT

- In order to provide food to our growing population, we need to adopt certain agricultural practices.
- Same kind of plants cultivated at a place constitute a crop.
- In India, crops can be broadly categorised into two types based on seasons - rabi and kharif crops.
- It is necessary to prepare soil by tilling and levelling. Ploughs and levellers are used for this purpose.
- Sowing of seeds at appropriate depths and distances gives good yield. Good variety of seeds are sown after selection of healthy seeds. Sowing is done by seed drills.
- Soil needs replenishment and enrichment through the use of organic manure and fertilisers. Use of chemical fertilisers has increased tremendously with the introduction of new crop varieties.
- Supply of water to crops at appropriate intervals is called irrigation.
- Weeding involves removal of unwanted and uncultivated plants called weeds.
- Harvesting is the cutting of the mature crop manually or by machines.
- Separation of the grains from the chaff is called threshing.
- Proper storage of grains is necessary to protect them from pests and microorganisms.
- Food is also obtained from animals for which animals are reared. This is called animal husbandry.

Exercises

1. Select the correct word from the following list and fill in the blanks.
float, water, crop, nutrients, preparation
 - (a) The same kind of plants grown and cultivated on a large scale at a place is called _____.
 - (b) The first step before growing crops is _____ of the soil.

- (c) Damaged seeds would _____ on top of water.
 (d) For growing a crop, sufficient sunlight and _____ and _____ from the soil are essential.

2. Match items in column **A** with those in column **B**.

A

- (i) Kharif crops
 (ii) Rabi crops
 (iii) Chemical fertilisers
 (iv) Organic manure

B

- (a) Food for cattle
 (b) Urea and super phosphate
 (c) Animal excreta, cow dung urine and plant waste
 (d) Wheat, gram, pea
 (e) Paddy and maize

3. Give two examples of each.

- (a) *Kharif* crop
 (b) *Rabi* crop

4. Write a paragraph in your own words on each of the following.

- (a) Preparation of soil (b) Sowing
 (c) Weeding (d) Threshing

5. Explain how fertilisers are different from manure.

6. What is irrigation? Describe two methods of irrigation which conserve water.

7. If wheat is sown in the *kharif* season, what would happen? Discuss.

8. Explain how soil gets affected by the continuous plantation of crops in a field.

9. What are weeds? How can we control them?

10. Arrange the following boxes in proper order to make a flow chart of sugarcane crop production.

Sending crop to
sugar factory

1

Irrigation

2

Harvesting

3

Sowing

4

Preparation of
soil

5

Ploughing the
field

6

Manuring

7

11. Complete the following word puzzle with the help of clues given below.

Down

1. Providing water to the crops.
2. Keeping crop grains for a long time under proper conditions.
5. Certain plants of the same kind grown on a large scale.

Across

3. A machine used for cutting the matured crop.
4. A *rabi* crop that is also one of the pulses.
6. A process of separating the grain from chaff.

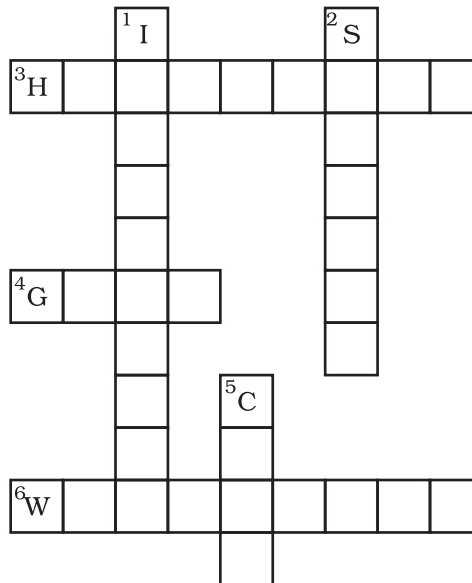

Extended Learning — Activities and Projects

1. Sow some seeds in the soil and arrange to water them by drip irrigation. Observe daily.
 - (i) Do you think it can save water?
 - (ii) Note the changes in the seed.
2. Collect different types of seeds and put them in small bags. Label them.
3. Collect pictures of some other agricultural machines and paste them in a file. Write their names and uses.
4. Project Work
Visit a farm, nursery or a garden nearby. Gather information about
 - (i) importance of seed selection.
 - (ii) method of irrigation.

- (iii) effect of extreme cold and extreme hot weather on the plants.
- (iv) effect of continuous rain on the plants.
- (v) fertilisers/manure used.

An Example for Field Trip Work

Himanshu and his friends were very anxious and curious to go to Thikri village. They went to Shri Jiwan Patel's farmhouse. They had taken bags to collect some seeds and other things.

Himanshu : Sir *namaskar*, I am Himanshu. Here are my friends Mohan, David and Sabiha. We want some information about crops. Please guide us.

Shri Patel : *Namaskar* and welcome all of you. What are your queries?

Sabiha : When did you start this work and what are the main crops that you grow?

Shri Patel : About 75 years ago, my grandfather started this work. The main crops that we grow are wheat, gram, soyabean and *moong*.

David : Sir, can you tell us the difference between traditional and modern agricultural practices?

Shri Patel : Earlier we used traditional tools like sickle, bullock plough, trowel, etc., and depended on rain water for irrigation. But now we use modern methods of irrigation. We use implements like tractors, cultivators, seed drill and harvester. We get good quality seeds. We carry out soil testing and use manure and fertilisers. New information about agriculture is obtained through radio, T.V. and other sources. As a result we are able to get good crops on a large scale. This year we got 9 to 11 quintals of gram crop/acre and 20 to 25 quintals of wheat/acre. In my opinion awareness of new technology is important for better crop yield.

Mohan : Sabiha, come here and see some earthworms. Are they helpful to the farmers?

Sabiha : Oh Mohan! we learnt about it in Class VI.

Shri Patel : Earthworms turn the soil and loosen it for proper aeration, so they help the farmer.

David : Can we have some seeds of the crops you grow here?

[They put some seeds, fertilisers and soil sample in the bags.]

Himanshu : Sir, we are thankful to you for making this visit pleasant and for providing useful information.



You have seen several kinds of plants and animals. However, there are other living organisms around us which we normally cannot see. These are called **microorganisms** or **microbes**. For example, you might have observed that during the rainy season moist bread gets spoilt and its surface gets covered with greyish white patches. Observe these patches through a magnifying glass. You will see tiny, black rounded structures. Do you know what these structures are and where do these come from?

2.1 Microorganisms

Activity 2.1

Collect some moist soil from the field in a beaker and add water to it. After the soil particles have settled down, observe a drop of water from the beaker under a microscope. What do you see ?

Activity 2.2

Take a few drops of water from a pond. Spread on a glass slide and observe through a microscope.

Do you find tiny organisms moving around?

These observations show that water and soil are full of tiny organisms, though not all of them fall into the category of microbes. These microorganisms or microbes are so small in size that they cannot be seen with the unaided eye. Some of these, such as the fungus that grows on bread, can be seen with a magnifying glass. Others cannot be seen without the help of a microscope. That is why these are called microorganisms or microbes.

Microorganisms are classified into four major groups. These groups are **bacteria, fungi, protozoa** and some **algae**. Some of these common microorganisms are shown in Figs. 2.1 - 2.4.

Viruses are also microscopic but are different from other microorganisms. They, however, reproduce only inside the cells of the host organism, which may be a bacterium, plant or animal. Some of the viruses are shown in Fig. 2.5. Common ailments like cold, influenza (flu) and most coughs are caused by viruses. Serious diseases like polio and chicken pox are also caused by viruses.

Diseases like dysentery and malaria are caused by protozoa(protozoans) whereas typhoid and tuberculosis (TB) are bacterial diseases.

You have learnt about some of these microorganisms in Classes VI and VII.

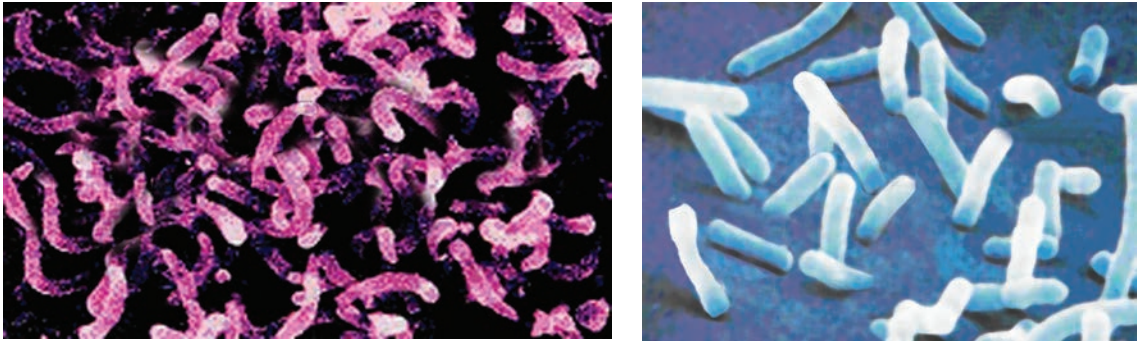
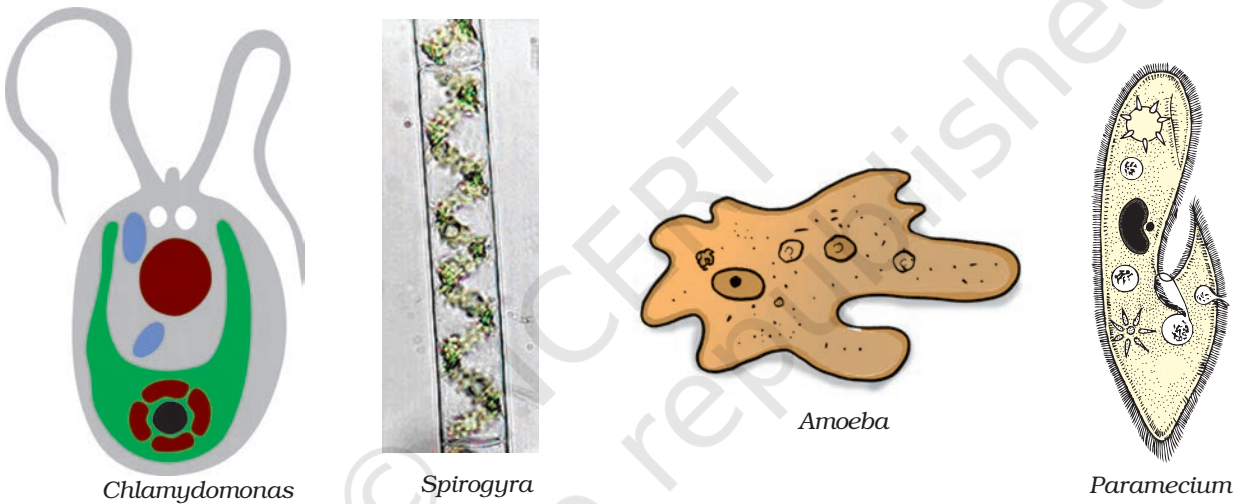

Fig. 2.1: Bacteria



Chlamydomonas

Spirogyra

Amoeba

Paramecium

Fig. 2.2 : Algae

Fig. 2.3 : Protozoa

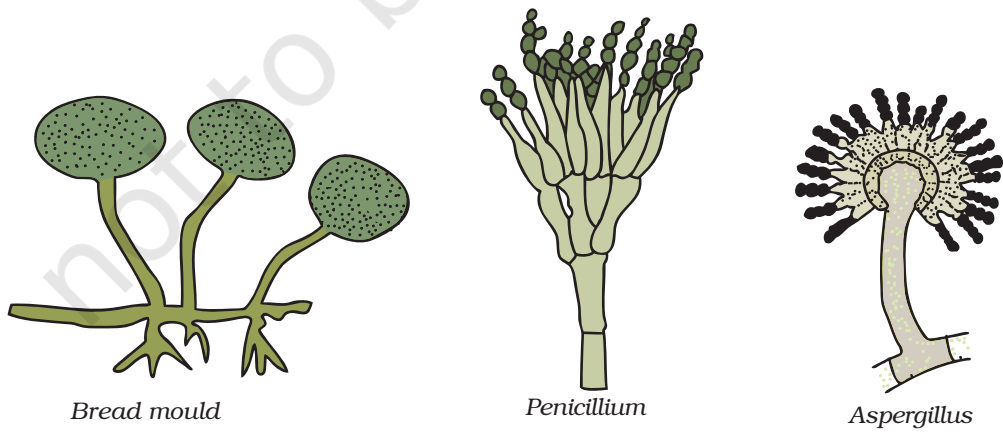

Bread mould

Penicillium

Aspergillus

Fig. 2.4 : Fungi

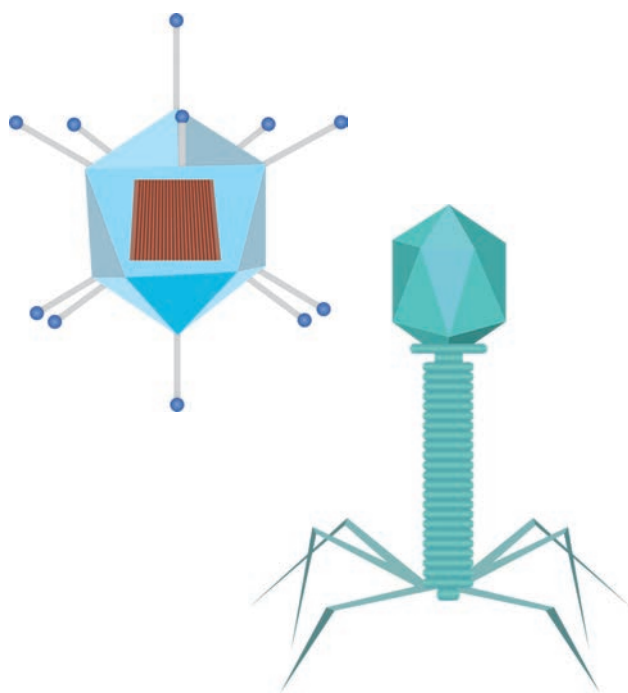

Fig. 2.5 : Viruses

2.2 Where do Microorganisms Live?

Microorganisms may be single-celled like bacteria, some algae and protozoa, or multicellular, such as many algae and fungi. They live in all types of environment, ranging from ice cold climate to hot springs; and deserts to marshy lands. They are also found inside the bodies of animals including humans. Some microorganisms grow on other organisms while others exist freely.

2.3 Microorganisms and Us

Microorganisms play an important role in our lives. Some of them are beneficial in many ways whereas some others are harmful and cause diseases. Let us study about them in detail.

Friendly Microorganisms

Microorganisms are used for various purposes. They are used in the preparation of curd, bread and cake.

Microorganisms have been used for the production of alcohol since ages.

They are also used in cleaning up of the environment. For example, the organic wastes (vegetable peels, remains of animals, faeces, etc.) are broken down into harmless and usable substances by bacteria. Recall that bacteria are also used in the preparation of medicines. In agriculture they are used to increase **soil fertility** by fixing nitrogen.

Making of Curd and Bread

You have learnt in Class VII that milk is turned into curd by bacteria.



I saw that my mother added a little curd to warm milk to set curd for the next day. I wonder why?

Curd contains several microorganisms. Of these, the bacterium, *Lactobacillus* promotes the formation of curd. It multiplies in milk and converts it into curd. Bacteria are also involved in the making of cheese, pickles and many other food items. An important ingredient of *rava* (*sooji*) *idlis* and *bhaturas* is curd. Can you guess why? Bacteria and yeast are also helpful for fermentation of rice *idlis* and *dosa* batter.

Activity 2.3

Take $\frac{1}{2}$ kg flour (*atta* or *maida*), add some sugar and mix with warm water. Add a small amount of yeast powder and knead to make a soft dough. What do you observe after two hours? Did you find the dough rising?

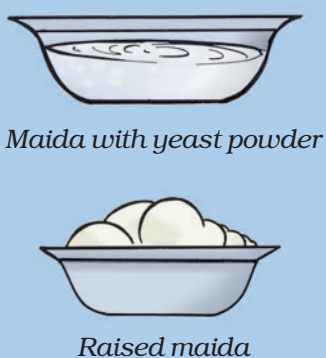

Fig. 2.6

Yeast reproduces rapidly and produces carbon dioxide during respiration. Bubbles of the gas fill the dough and increase its volume (Fig. 2.6). This is the basis of the use of yeast in the baking industry for making breads, pastries and cakes.

Commercial Use of Microorganisms

Microorganisms are used for the large scale production of alcohol, wine and acetic acid (vinegar). Yeast is used for commercial production of alcohol and wine. For this purpose yeast is grown on natural sugars present in grains like barley, wheat, rice, crushed fruit juices, etc.

Activity 2.4

Take a 500 mL beaker filled upto $\frac{3}{4}$ with water. Dissolve 2-3 teaspoons of sugar in it. Add half a

spoon of yeast powder to the sugar solution. Keep it covered in a warm place for 4-5 hours. Now smell the solution. Can you get a smell?

This is the smell of alcohol as sugar has been converted into alcohol by yeast. This process of conversion of sugar into alcohol is known as **fermentation**.



Louis Pasteur discovered fermentation in 1857.

Medicinal Use of Microorganisms

Whenever you fall ill the doctor may give you some antibiotic tablets, capsules or injections such as of penicillin. The source of these medicines is microorganisms. These medicines kill or stop the growth of the disease-causing microorganisms. Such medicines are called **antibiotics**. These days a number of antibiotics are being produced from bacteria and fungi. Streptomycin, tetracycline and erythromycin are some of the

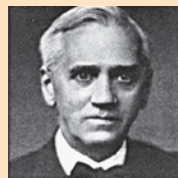

In 1929, Alexander Fleming was working on a culture of disease-causing bacteria. Suddenly he found the spores of a little green mould in one of his culture plates. He observed that the presence of mould prevented the growth of bacteria. In fact, it also killed many of these bacteria. From this the mould penicillin was prepared.

commonly known antibiotics which are made from fungi and bacteria. The antibiotics are manufactured by growing specific microorganisms and are used to cure a variety of diseases.

Antibiotics are even mixed with the feed of livestock and poultry to check microbial infection in animals. They are also used to control many plant diseases.

It is important to remember that antibiotics should be taken only on the advice of a qualified doctor. Also you must complete the course prescribed by the doctor. If you take antibiotics when not needed or in wrong doses, it may make the drug less effective when you might need it in future. Also antibiotics taken unnecessarily may kill the beneficial bacteria in the body. Antibiotics, however, are not effective against cold and flu as these are caused by viruses.

Vaccine



Why are children/infants given vaccination?

When a disease-carrying microbe enters our body, the body produces **antibodies** to fight the invader. The body also remembers how to fight the microbe if it enters again. If dead or weakened microbes are introduced into a healthy body, the body fights and kills the invading bacteria by producing suitable antibodies. The antibodies remain in the body and we are protected

from the disease-causing microbes for ever. This is how a vaccine works. Several diseases, including cholera, tuberculosis, smallpox and hepatitis can be prevented by vaccination.



Edward Jenner discovered the vaccine for smallpox in 1798.

In your childhood, you must have been given injections to protect yourself against several diseases. Can you prepare a list of these diseases? You may take help from your parents.

It is essential to protect all children against these diseases. Necessary vaccines are available in the nearby hospitals. You might have seen the advertisement on TV and newspapers regarding protection of children against polio under the Pulse Polio Programme. Polio drops given to children are actually a vaccine.

A worldwide campaign against smallpox has finally led to its eradication from most parts of the world.

These days vaccines are made on a large scale from microorganisms to protect humans and other animals from several diseases.

Increasing Soil Fertility

Some bacteria (Fig. 2.7) are able to fix nitrogen from the atmosphere to enrich soil with nitrogen and increase its fertility. These microbes are commonly called biological nitrogen fixers.

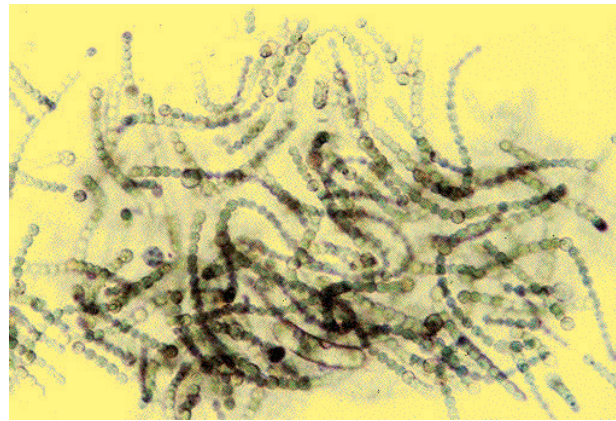

Fig. 2.7 : The Nitrogen fixing cyanobacteria (blue green algae)

Cleaning the Environment

Boojho and Paheli had observed the school gardener making manure. Along with their friends, they collected wastes of plants, vegetables and fruits from nearby houses and gardens. They put them in a pit meant for waste disposal. After some time, it decomposed and got converted to manure. Boojho and Paheli wanted to know how this had happened.

Activity 2.5

Take two pots and fill each pot half with soil. Mark them A and B. Put plant waste in pot A and things like polythene bags, empty glass bottles and broken plastic toys in pot B. Put the pots aside. Observe them after 3-4 weeks.

Do you find any difference in the contents of the two pots? If so, what is the difference? You will find that plant waste in pot A, has been decomposed. How did this happen? The plant waste has been converted into manure by the action of microbes. The nutrients

released in the process can be used by the plants again.

Did you notice that in pot B, the polythene bags, empty glasses, bottles and broken toy parts did not undergo any such change? The microbes could not 'act' on them and convert them into manure.

You often see large amounts of dead organic matter in the form of decaying plants and sometimes dead animals on the ground. You find that they disappear after some time. This is because the microorganisms decompose dead organic waste of plants and animals converting them into simple substances. These substances are again used by other plants and animals. Thus, microorganisms can be used to degrade the harmful and smelly substances and thereby clean up the environment.

2.4 Harmful Microorganisms

Microorganisms are harmful in many ways. Some of the microorganisms cause diseases in human beings, plants and animals. Such disease-causing

microorganisms are called **pathogens**. Some microorganisms spoil food, clothing and leather. Let us study more about their harmful activities.

Disease causing Microorganisms in Humans

Pathogens enter our body through the air we breathe, the water we drink or the food we eat. They can also get transmitted by direct contact with an infected person or carried by an animal. Microbial diseases that can spread from an infected person to a healthy person through air, water, food or physical contact are called **communicable diseases**. Examples of such diseases include cholera, common cold, chicken pox and tuberculosis.

When a person suffering from common cold sneezes, fine droplets of moisture carrying thousands of viruses are spread in the air. The virus may enter the body of a healthy person while breathing and cause infection.

There are some insects and animals which act as **carriers** of disease-causing microbes. Housefly is one such carrier. The flies sit on the garbage and animal excreta. Pathogens stick to their bodies. When these flies sit on uncovered food they may transfer the pathogens. Whoever eats the contaminated food is likely to get sick. So, it is advisable to always keep food covered. Avoid consuming uncovered items of food. Another example of a carrier is the female *Anopheles* mosquito (Fig. 2.8), which carries the parasite of malaria (*Plasmodium*). Female *Aedes* mosquito acts as carrier of dengue virus. How can we control the spread of malaria or dengue?



Fig. 2.8 : Female *Anopheles* mosquito



Then how do you prevent the spread of communicable diseases?



Why does the teacher keep telling us not to let water collect anywhere in the neighbourhood?

We should keep a handkerchief on the nose and mouth while sneezing. It is better to keep a distance from infected persons.



All mosquitoes breed in water. Hence, one should not let water collect anywhere, in coolers, tyres, flower pot, etc. By keeping the surroundings clean and dry we can prevent mosquitoes from breeding. Try to make a list of measures which help to avoid the spread of malaria.

Table 2.1: Some Common Human Diseases caused by Microorganisms

Human Disease	Causative Microorganism	Mode of Transmission	Preventive Measures (General)
Tuberculosis	Bacteria	Air	Keep the patient in complete isolation. Keep the personal belongings of the patient away from those of the others. Vaccination to be given at suitable age.
Measles	Virus	Air	
Chicken Pox	Virus	Air/Contact	
Polio	Virus	Air/Water	
Cholera	Bacteria	Water/Food	Maintain personal hygiene and good sanitary habits. Consume properly cooked food and boiled drinking water. Vaccination.
Typhoid	Bacteria	Water	
Hepatitis A	Virus	Water	Drink boiled drinking water. Vaccination.
Malaria	Protozoa	Mosquito	Use mosquito net and repellents. Spray insecticides and control breeding of mosquitoes by not allowing water to collect in the surroundings.

Some of the common diseases affecting humans, their mode of transmission and few general methods of prevention are shown in Table 2.1.

Disease causing Microorganisms in Animals

Several microorganisms not only cause diseases in humans and plants, but also

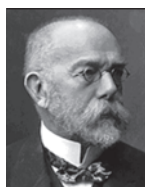

Robert Köch (1876) discovered the bacterium (*Bacillus anthracis*) which causes anthrax disease.

in other animals. For example, anthrax is a dangerous human and cattle disease caused by a bacterium. Foot and mouth disease of cattle is caused by a virus.

Disease causing Microorganisms in Plants

Several microorganisms cause diseases in plants like wheat, rice, potato, sugarcane, orange, apple and others. The diseases reduce the yield of crops. See Table 2.2 for some such plant diseases. They can be controlled by the

Table 2.2: Some Common Plant Diseases caused by Microorganisms

Plant Diseases	Micro-organism	Mode of Transmission
Citrus canker	Bacteria	Air
Rust of wheat	Fungi	Air, seeds
Yellow vein mosaic of <i>bhindi</i> (Okra)	Virus	Insect

use of certain chemicals which kill the microbes.

Food Poisoning

Boojho was invited by his friend to a party and he ate a variety of foodstuff. On reaching home he started vomiting and had to be taken to a hospital. The doctor said that this condition could be due to food poisoning.



Paheli wonders how food can become a 'poison'.

Food poisoning could be due to the consumption of food spoilt by some microorganisms. Microorganisms that grow on our food sometimes produce toxic substances. These

make the food poisonous causing serious illness and even death. So, it is very important that we preserve food to prevent it from being spoilt.

2.5 Food Preservation

In Chapter 1, we have learnt about the methods used to preserve and store food grains. How do we preserve cooked food at home? You know that bread left unused under moist conditions is attacked by fungus. Microorganisms spoil our food. Spoiled food emits bad smell and has a bad taste and changed colour. Is spoiling of food a chemical reaction?

Paheli bought some mangoes but she could not eat them for a few days. Later she found that they were spoilt and rotten. But she knows that the mango pickle her grandmother makes does not spoil for a long time. She is confused.

Let us study the common methods of preserving food in our homes. We have to save it from the attack of microorganisms.

Chemical Method

Salts and edible oils are the common chemicals generally used to check the growth of microorganisms. Therefore they are called **preservatives**. We add salt or acid preservatives to pickles to prevent the attack of microbes. Sodium benzoate and sodium metabisulphite are common preservatives. These are also used in jams and squashes to check their spoilage.

Preservation by Common Salt

Common salt has been used to preserve meat and fish for ages. Meat and fish are covered with dry salt to check the growth of bacteria. Salting is also used to preserve *amla*, raw mangoes, tamarind, etc.

Preservation by Sugar

Jams, jellies and squashes are preserved by sugar. Sugar reduces the moisture content which inhibits the growth of bacteria which spoil food.

Preservation by Oil and Vinegar

Use of oil and vinegar prevents spoilage of pickles because bacteria cannot live in such an environment. Vegetables, fruits, fish and meat are often preserved by this method.

Heat and Cold Treatments

You must have observed your mother boiling milk before it is stored or used. Boiling kills many microorganisms.

Similarly, we keep our food in the refrigerator. Low temperature inhibits the growth of microbes.



Why does the milk that comes in packets not spoil? My mother told me that the milk is 'pasteurised'. What is pasteurisation?

Pasteurised milk can be consumed without boiling as it is free from harmful microbes. The milk is heated to about 70°C for 15 to 30 seconds and then suddenly chilled and stored. By doing so, it prevents the growth of microbes. This process was discovered by Louis Pasteur. It is called **pasteurisation**.

Storage and Packing

These days dry fruits and even vegetables are sold in sealed air tight packets to prevent the attack of microbes.

2.6 Nitrogen Fixation

You have learnt about the bacterium *Rhizobium* in Classes VI and VII. It is involved in the fixation of nitrogen in leguminous plants (pulses). Recall that *Rhizobium* lives in the root nodules of leguminous plants (Fig. 2.9), such as beans and peas, with which it has a symbiotic relationship. Sometimes nitrogen gets fixed through the action of lightning. But you know that the amount of nitrogen in the atmosphere remains constant. You may wonder how? Let us understand this in the next section.

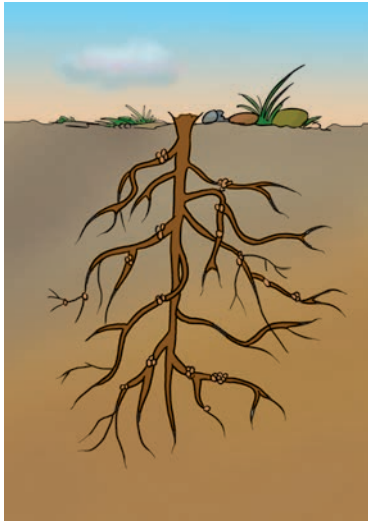

Fig. 2.9 : Roots of a leguminous plant with root nodules

2.7 Nitrogen cycle

Our atmosphere has 78% nitrogen gas. Nitrogen is one of the essential constituents of all living organisms as part of proteins, chlorophyll, nucleic acids and vitamins. The atmospheric

nitrogen cannot be taken directly by plants and animals. Certain bacteria and blue green algae present in the soil fix nitrogen from the atmosphere and convert it into compounds of nitrogen. Once nitrogen is converted into these usable compounds, it can be utilised by plants from the soil through their root system. Nitrogen is then used for the synthesis of plant proteins and other compounds. Animals feeding on plants get these proteins and other nitrogen compounds (Fig. 2.10).

When plants and animals die, bacteria and fungi present in the soil convert the nitrogenous wastes into nitrogenous compounds to be used by plants again. Certain other bacteria convert some part of them to nitrogen gas which goes back into the atmosphere. As a result, the percentage of nitrogen in the atmosphere remains more or less constant.

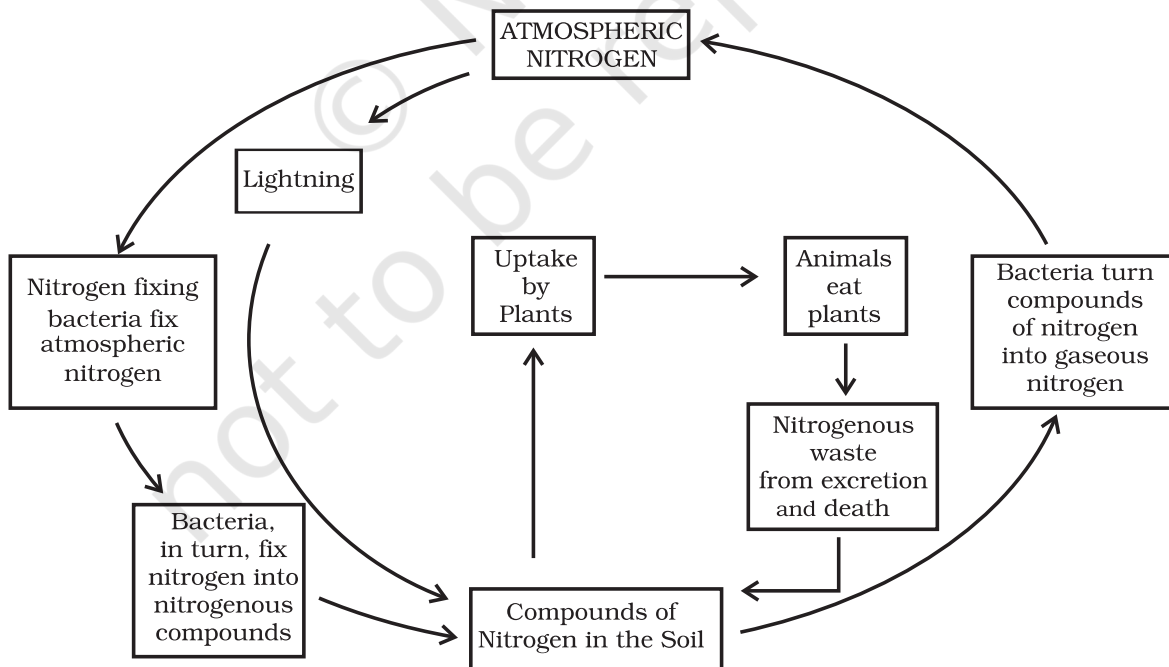

Fig. 2.10 : Nitrogen cycle

KEYWORDS

ALGAE

ANTIBIOTICS

ANTIBODIES

BACTERIA

CARRIER

COMMUNICABLE
DISEASES

FERMENTATION

FUNGI

LACTOBACILLUS

MICROORGANISM

NITROGEN CYCLE

NITROGEN FIXATION

PASTEURISATION

PATHOGEN

PRESERVATION

PROTOZOA

RHIZOBIUM

VACCINE

VIRUS

YEAST

WHAT YOU HAVE LEARNT

- Microorganisms are too small and are not visible to the unaided eye.
- They can live in all kinds of environment, ranging from ice cold climate to hot springs and deserts to marshy lands.
- Microorganisms are found in air, water and in the bodies of plants and animals.
- They may be unicellular or multicellular.
- Microorganisms include bacteria, fungi, protozoa and some algae. Viruses, though different from the above mentioned living organisms, are considered microbes.
- Viruses are quite different from other microorganisms. They reproduce only inside the host organism: bacterium, plant or animal cell.
- Some microorganisms are useful for commercial production of medicines and alcohol.
- Some microorganisms decompose the organic waste and dead plants and animals into simple substances and clean up the environment.
- Protozoans cause serious diseases like dysentery and malaria.
- Some of the microorganisms grow on our food and cause food poisoning.
- Some microorganisms reside in the root nodules of leguminous plants. They can fix nitrogen from air into soil and increase the soil fertility.
- Some bacteria present in the soil fix nitrogen from the atmosphere and convert into nitrogenous compounds.
- Certain bacteria convert compounds of nitrogen present in the soil into nitrogen gas which is released to the atmosphere.

Exercises

- Fill in the blanks.
 - Microorganisms can be seen with the help of a _____.
 - Blue green algae fix _____ directly from air and enhance fertility of soil.
 - Alcohol is produced with the help of _____.
 - Cholera is caused by _____.
- Tick the correct answer.
 - Yeast is used in the production of
(i) sugar (ii) alcohol (iii) hydrochloric acid (iv) oxygen
 - The following is an antibiotic
(i) Sodium bicarbonate (ii) Streptomycin (iii) Alcohol (iv) Yeast
 - Carrier of malaria-causing protozoan is
(i) female *Anopheles* mosquito (ii) cockroach
(iii) housefly (iv) butterfly
 - The most common carrier of communicable diseases is
(i) ant (ii) housefly (iii) dragonfly (iv) spider
 - The bread or *idli* dough rises because of
(i) heat (ii) grinding (iii) growth of yeast cells (iv) kneading
 - The process of conversion of sugar into alcohol is called
(i) nitrogen fixation (ii) moulding (iii) fermentation (iv) infection
- Match the organisms in Column **A** with their action in Column **B**.

A	B
(i) Bacteria	(a) Fixing nitrogen
(ii) <i>Rhizobium</i>	(b) Setting of curd
(iii) <i>Lactobacillus</i>	(c) Baking of bread
(iv) Yeast	(d) Causing malaria
(v) A protozoan	(e) Causing cholera
(vi) A virus	(f) Causing AIDS
	(g) Producing antibodies
- Can microorganisms be seen with the naked eye? If not, how can they be seen?

5. What are the major groups of microorganisms?
6. Name the microorganisms which can fix atmospheric nitrogen in the soil.
7. Write 10 lines on the usefulness of microorganisms in our lives.
8. Write a short paragraph on the harmful effects of microorganisms.
9. What are antibiotics? What precautions must be taken while taking antibiotics?

Extended Learning — Activities and Projects

1. Pull out a gram or bean plant from the field. Observe its roots. You will find round structures called root nodules on the roots. Draw a diagram of the root and show the root nodules.
2. Collect the labels from the bottles of jams and jellies. Write down the list of contents printed on the labels.
3. Visit a doctor. Find out why antibiotics should not be overused. Prepare a short report.
4. Project : Requirements – 2 test tubes, marker pen, sugar, yeast powder, 2 balloons and lime water.

Take two test tubes and mark them A and B. Clamp these tubes in a stand and fill them with water leaving some space at the top. Put two spoonfuls of sugar in each of the test tubes. Add a spoonful of yeast in test tube B. Inflate the two balloons incompletely. Now tie the balloons on the mouths of each test tube. Keep them in a warm place, away from sunlight. Watch the setup every day for next 3-4 days. Record your observations and think of an explanation.

Now take another test tube filled 1/4 with lime water. Remove the balloon from test tube B in such a manner that gas inside the balloon does not escape. Fit the balloon on the test tube and shake well. Observe and explain.

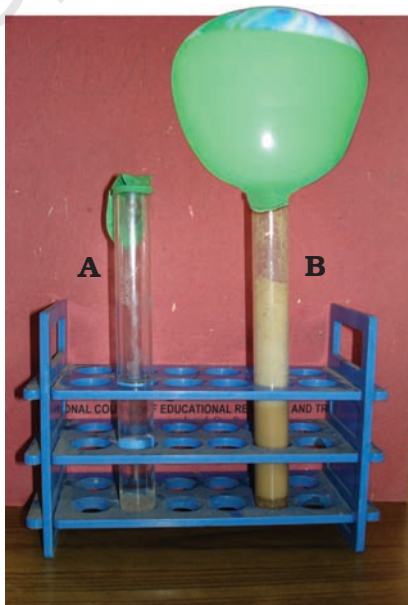

Did You Know?

Bacteria have lived on the earth for much longer than human beings. They are such hardy organisms that they can live under extreme conditions. They have been found living in boiling mudpots and extremely cold icy waters. They have been found in lakes of caustic soda and in pools of concentrated sulphuric acid. They can survive at depths of several kilometres. They probably can survive in space, too. A kind of bacterium was recovered from a camera which stood on the moon for two years. There is probably no environment in which bacteria cannot survive.

© NCERT
not to be republished



0854CH03

The clothes which we wear are made of fabrics. Fabrics are made from fibres obtained from natural or artificial sources. Can you name some natural fibres? Fibres are also used for making a large variety of household articles. Make a list of some common articles made from fibres. Try to separate them into those made from natural fibres and those made from artificial fibres. Make entries in Table 3.1.

Table 3.1 : Natural and Artificial Fibres

S. No.	Name of Article	Type of Fibre (Natural/artificial)

Why did you label some fibres as artificial?

You have read in your previous classes that natural fibres like cotton, wool, silk, etc., are obtained from plants or animals. The synthetic fibres, on the other hand, are made by human beings. That is why these are called **synthetic** or **man-made** fibres.

3.1 What are Synthetic Fibres?

Try to recall the uniform pattern found in a necklace of beads joined with the help of a thread [Fig. 3.1(a)]. Or, try to join a number of paper clips together to make a long chain, as in Fig. 3.1 (b). Is there any similarity between the two?

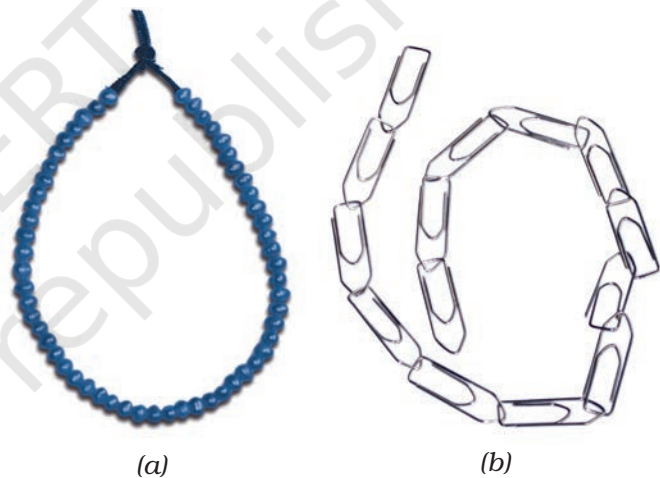

Fig. 3.1 : (a) Beads and (b) Paper clips joined to form long chains

A synthetic fibre is also a chain of small units joined together. Each small unit is actually a chemical substance. Many such small units combine to form a large single unit called a **polymer**. The word 'polymer' comes from two Greek words; *poly* meaning *many* and *mer* meaning *part/unit*. So, a polymer is made of many repeating units.

Polymers occur in nature also. Cotton, for example, is a polymer called **cellulose**. Cellulose is made up of a large number of glucose units.

3.2 Types of Synthetic Fibres

Rayon

You have read in Class VII that silk fibre obtained from silkworm was discovered in China and was kept as a closely guarded secret for a long time. Fabric obtained from silk fibre was very costly. But its beautiful texture fascinated everybody. Attempts were made to make silk artificially. Towards the end of the nineteenth century, scientists were successful in obtaining a fibre having properties similar to that of silk. Such a fibre was obtained by chemical treatment of wood pulp. This fibre was called **rayon** or **artificial silk**. Although rayon is obtained from a natural source, wood pulp, yet it is a man-made fibre. It is cheaper than silk and can be woven like silk fibres. It can also be dyed in a wide variety of colours. Rayon is mixed with cotton to make bed sheets or mixed with wool to make carpets. (Fig. 3.2.)



Fig. 3.2 : Articles made of rayon

Nylon

Nylon is another man-made fibre. In 1931, it was made without using any natural raw material (from plant or animal). It was prepared from coal, water and air. It was the first fully synthetic fibre.

Nylon fibre was strong, elastic and light. It was lustrous and easy to wash. So, it became very popular for making clothes.

We use many articles made from nylon, such as socks, ropes, tents, toothbrushes, car seat belts, sleeping bags, curtains, etc. (Fig. 3.3). Nylon is



Fig. 3.3: Various articles made from nylon

Is nylon fibre really so strong that we can make nylon parachutes and ropes for rock climbing?





Fig. 3.4: Use of nylon Fibres

also used for making parachutes and ropes for rock climbing (Fig. 3.4). A nylon thread is actually stronger than a steel wire.

Let us find out.

Activity 3.1

Take an iron stand with a clamp. Take a cotton thread of about 60 cm length. Tie it to the clamp so that it hangs freely from it as shown in Fig. 3.5. At the free end suspend

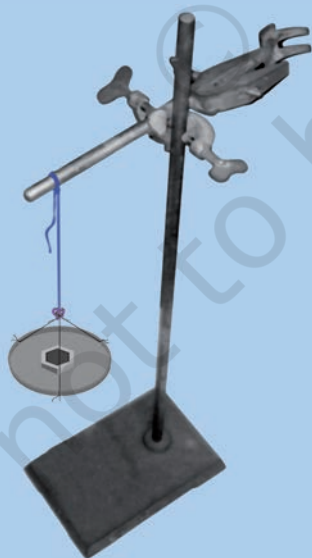

Fig. 3.5: An iron stand with a thread hanging from the clamp

a pan so that weight can be placed in it. Add weight one by one till the thread breaks. Note down the total weight required to break the thread. This weight indicates the strength of the fibre. Repeat the same activity with threads of wool, polyester, silk and nylon. Tabulate the data as shown in Table 3.2. Arrange the threads in order of their increasing strength.

Observation Table 3.2

S. No.	Type of Thread/Fibre	Total Weight required to break the Thread
1.	Cotton	
2.	Wool	
3.	Silk	
4.	Nylon	

You may use a hook or a nail on the wall for hanging the fibres and a polythene bag at the other end. In place of weights you may use marbles (or pebbles) of similar size.

(Precaution : Note that all threads should be of the same length and almost of the same thickness.)

Polyester and Acrylic

Polyester is another synthetic fibre. Fabric made from this fibre does not get wrinkled easily. It remains crisp and is easy to wash. So, it is quite suitable for making dress material. You must have seen people wearing polyester shirts and other dresses. Terylene is a popular polyester. It can be drawn into very fine

fibres that can be woven like any other yarn.



My mother always buys PET bottles and PET jars for storing rice and sugar. I wonder what PET is!

PET (polyethylene terephthalate) is a very familiar form of polyester. It is used for making bottles, utensils, films, wires and many other useful products.

Look around and make a list of things made of polyester.

Polyester (Poly+ester) is actually made up of the repeating units of a chemical called an ester. Esters are the chemicals which give fruits their smell. Fabrics are sold by names like polycot, polywool, terrycot, etc. As the name suggests, these are made by mixing two types of fibres. Polycot is a mixture of polyester and cotton. Polywool is a mixture of polyester and wool.

We wear sweaters and use shawls or blankets in the winter. Many of these are actually not made from natural wool, though they appear to resemble wool. These are prepared from another type of synthetic fibre called **acrylic**. The wool obtained from natural sources is quite expensive, whereas clothes made from acrylic are relatively cheap. They are available in a variety of colours. Synthetic fibres are more durable and affordable which makes them more popular than natural fibres.

You have already performed an activity of burning natural and synthetic fibres (Activity 3.6 of Class VII). What did you observe? When you burn synthetic fibres you find that their behaviour is different from that of the natural fibres. You must have noticed that synthetic fibres melt on heating. This is actually a disadvantage of synthetic fibres. If the clothes catch fire, it can be disastrous. The fabric melts and sticks to the body of the person wearing it. We should, therefore, not wear synthetic clothes while working in the kitchen or in a laboratory.



Oh! Now I understand why my mother never wears polyester clothes while working in the kitchen.

All the synthetic fibres are prepared by a number of processes using raw materials of petroleum origin, called **petrochemicals**.

3.3 Characteristics of Synthetic Fibres

Imagine that it is a rainy day. What kind of umbrella would you use and why? Synthetic fibres possess unique characteristics which make them popular dress materials. They dry up quickly, are durable, less expensive, readily available and easy to maintain. Perform the following activity and learn for yourself.

Activity 3.2

Take two cloth pieces of the same size, roughly half a metre square each. One of these should be from natural fibre. The other could be a synthetic fibre. You can take help of your parents in selecting these pieces. Soak the pieces in different mugs each containing the same amount of water. Take the pieces out of the containers after five minutes and spread them in the sun for a few minutes. Compare the volume of the water remaining in each container.

Do synthetic fabrics soak less/more water than the natural fabrics? Do they take less/more time to dry?

What does this activity tell you about the characteristics of the synthetic fabrics?

Find out from your parents about the durability, cost and maintenance of these fabrics, compared to the natural fabrics.

3.4 Plastics

You must be familiar with many plastic articles used everyday. Make a list of such items and their uses.

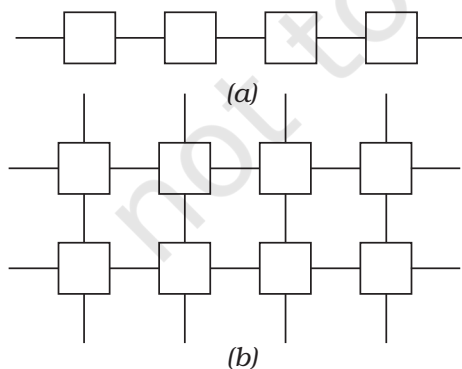

Fig. 3.6 : (a) Linear (b) Cross-linked arrangements

Plastic is also a polymer like the synthetic fibre. All plastics do not have the same type of arrangement of units. In some it is linear, whereas in others it is cross-linked. (Fig. 3.6). Plastic articles are available in all possible shapes and sizes as you can see in Fig. 3.7. Have you ever wondered how this is possible? The fact is that plastic is easily mouldable i.e. can be shaped in any form. Plastic can be recycled, reused, coloured, melted, rolled into sheets or made into wires. That is why it finds such a variety of uses.



Fig. 3.7 : Various articles made of plastics

Polythene (Poly+ethene) is an example of a plastic. It is used for making commonly used polythene bags.

Now, try to bend a piece of plastic yourself. Can all the plastic articles be bent easily?

You will observe that some plastic articles can bend easily while some break when forced to bend. When we

add hot water to a plastic bottle, it gets deformed. Such plastic which gets deformed easily on heating and can be bent easily are known as **thermoplastics**. Polythene and PVC are some of the examples of thermoplastics. These are used for manufacturing toys, combs and various types of containers.

On the other hand, there are some plastics which when moulded once, can not be softened by heating. These are called **thermosetting plastics**. Two examples are bakelite and melamine. Bakelite is a poor conductor of heat and electricity. It is used for making electrical switches, handles of various utensils, etc. Melamine is a versatile material. It resists fire and can tolerate heat better than other plastics. It is used for making floor tiles, kitchenware and fabrics which resist fire. Fig. 3.8 shows the various uses of thermoplastics and thermosetting plastics.



Fig. 3.8 : Some articles made of plastic

3.5 Plastics as Materials of Choice

Today if we think of storing a food item, water, milk, pickles, dry food etc., plastic containers seem most convenient. This is because of their light weight, lower price, good strength and easy handling. Being lighter as compared to metals, plastics are used in cars, aircrafts and spacecrafts, too. The list is endless if we start counting articles like slippers, furniture, decoration pieces, etc.

Now, let us discuss the characteristic properties of plastics.

Plastic is Non-reactive

You know that metals like iron get rusted when left exposed to moisture and air. But plastics do not react with water and air. They are not corroded easily. That is why they are used to store various kinds of material, including many chemicals.

Plastic is Light, Strong and Durable

Talk to your parents or grandparents about the types of buckets that were used in the past. What is the material of the buckets or mugs you are using today? What are the advantages of using a plastic container? Since plastic is very light, strong, durable and can be moulded into different shapes and sizes, it is used for various purposes. Plastics are generally cheaper than metals. They are widely used in industry and for household articles. Make a list of different kinds of plastic containers that you use in daily life.

Plastics are Poor Conductors

You have learnt above that plastics are poor conductors of heat and electricity. That is why electrical wires have plastic covering, and handles of screw drivers are made of plastic. As mentioned above, handles of frying pans are also made of plastic.

Did You Know?

- Plastics find extensive use in the healthcare industry. Some examples of their use are the packaging of tablets, threads used for stitching wounds, syringes, doctors' gloves and a number of medical instruments.
- Special plastic cookware is used in microwave ovens for cooking food. In microwave ovens, the heat cooks the food but does not affect the plastic vessel.
- Teflon is a special plastic on which oil and water do not stick. It is used for non-stick coating on cookwares.

- Fire-proof plastics: Although synthetic fibre catches fire easily, it is interesting to know that the uniforms of firemen have coating of melamine plastic to make them flame resistant.

3.6 Plastics and the Environment

When we go to the market, we usually get things wrapped in plastic or packed in polythene bags. That is one reason why plastic waste keeps getting accumulated in our homes. Ultimately, plastic finds its way to the garbage. Disposal of plastic is a major problem. Why?

A material which gets decomposed through natural processes, such as action by bacteria, is called **biodegradable**. A material which is not easily decomposed by natural processes is termed **non-biodegradable**.

Look at Table 3.3.

Table 3.3

Type of Waste	Approximate Time taken to Degenerate	Nature of Material
Peels of vegetable and fruits, leftover foodstuff, etc.	1 to 2 weeks	Biodegradable
Paper	10 to 30 days	Biodegradable
Cotton cloth	2 to 5 months	Biodegradable
Wood	10 to 15 years	Biodegradable
Woollen clothes	About a year	Biodegradable
Tin, aluminium, and other metal cans	100 to 500 years	Non-biodegradable
Plastic bags	Several years	Non-biodegradable

• Source: <http://edugreen.teri.res.in/explore/solwaste/types.htm>

Since plastic takes several years to decompose, it is not environment friendly. It causes environmental pollution. Besides, the burning process in the synthetic material is quite slow and it does not get completely burnt easily. In the process it releases lots of poisonous fumes into the atmosphere causing air pollution. How can this problem be solved?

Have you ever seen a garbage dump where animals are eating garbage? In the process of eating the food waste they swallow materials like polythene bags and wrappers of food. Can you imagine the consequences? The plastic material chokes the respiratory system of these animals, or forms a lining in their stomachs and can be the cause of their death.

The polybags carelessly thrown here and there are responsible for clogging the drains, too. Sometimes we are very careless and throw the wrappers of chips, biscuits and other eatables on the road or in parks or picnic places. Should we not think twice before doing so? As a responsible citizen what measures do you suggest to keep public places clean and free of plastic?

Avoid the use of plastics as far as possible. Make use of bags made of cotton or jute when you go for shopping. The biodegradable and non-biodegradable wastes should be collected separately and disposed off separately. Practise this in your homes. Can you suggest some other ways in which you can contribute towards reducing the use of plastic materials?

It is better to recycle plastic waste. Most of the thermoplastics can be recycled. Make a list of items that can be recycled. However, during recycling certain colouring agents are added. This limits its usage especially for storage of food.

As a responsible citizen remember the **5 R** principle. **Reduce, Reuse, Recycle, Recover and Refuse**. Develop habits which are environment friendly.

Fibre-wise

- Do not throw plastic bags in the water bodies or on the road.
- Take a cotton carry bag or a jute bag while going for shopping.
- Try to minimise the use of plastic materials e.g., use a steel lunch box instead of a plastic one.

KEYWORDS

ACRYLIC

ARTIFICIAL SILK

NYLON

PLASTIC

POLYESTER

POLYMER

POLYTHENE

RAYON

SYNTHETIC FIBRES

TERYLENE

THERMOPLASTICS

THERMOSETTING
PLASTICS

WHAT YOU HAVE LEARNT

- Synthetic fibres and plastics, like natural fibres, are made of very large units called polymers. Polymers are made up of many smaller units.
- While natural fibres are obtained from plants and animals, synthetic fibres are obtained by chemical processing of petrochemicals. Like natural fibres, these fibres can also be woven into fabrics.
- Synthetic fibres find uses ranging from many household articles like ropes, buckets, furniture, containers, etc., to highly specialised uses in aircrafts, ships, spacecrafts, healthcare, etc.
- Depending upon the types of chemicals used for manufacturing synthetic fibres, they are called Rayon, Nylon, Polyester and Acrylic.
- The different types of fibres differ from one another in their strength, water absorbing capacity, nature of burning, cost, durability etc.
- Today, life without plastics cannot be imagined. Be it home, or outside, plastic is everywhere.
- The waste created by plastics is not environment friendly. On burning, plastics release poisonous gases. On dumping in the ground they may take years to degenerate. This is because of their non-biodegradable nature.
- We need to use synthetic fibres and plastics in such a manner that we can enjoy their good qualities and at the same time minimise the environmental hazards for the living communities.

Exercises

1. Explain why some fibres are called synthetic.

2. Mark (✓) the correct answer.

Rayon is different from synthetic fibres because

- (a) it has a silk-like appearance.
- (b) it is obtained from wood pulp.
- (c) its fibres can also be woven like those of natural fibres.

3. Fill in the blanks with appropriate words.

- (a) Synthetic fibres are also called _____ or _____ fibres.
- (b) Synthetic fibres are synthesised from raw material called _____.
- (c) Like synthetic fibres, plastic is also a _____.

4. Give examples which indicate that nylon fibres are very strong.

5. Explain why plastic containers are favoured for storing food.

6. Explain the difference between thermoplastic and thermosetting plastics.

7. Explain why the following are made of thermosetting plastics.

- (a) Saucepan handles
- (b) Electric plugs/switches/plug boards

8. Categorise the materials of the following products into 'can be recycled' and 'cannot be recycled'.

Telephone instruments, plastic toys, cooker handles, carry bags, ball point pens, plastic bowls, plastic covering on electrical wires, plastic chairs, electrical switches.

9. Rana wants to buy shirts for summer. Should he buy cotton shirts or shirts made from synthetic material? Advise Rana, giving your reason.

10. Give examples to show that plastics are noncorrosive in nature.

11. Should the handle and bristles of a tooth brush be made of the same material? Explain your answer.

12. 'Avoid plastics as far as possible'. Comment on this advice.

13. Match the terms of column **A** correctly with the phrases given in column **B**.

A	B
(i) Polyester	(a) Prepared by using wood pulp
(ii) Teflon	(b) Used for making parachutes and stockings
(iii) Rayon	(c) Used to make non-stick cookwares
(iv) Nylon	(d) Fabrics do not wrinkle easily

14. 'Manufacturing synthetic fibres is actually helping conservation of forests'. Comment.
15. Describe an activity to show that thermoplastic is a poor conductor of electricity.

Extended Learning — Activities and Projects

1. Have you heard of the campaign : "Say No To Plastics". Coin a few more slogans of this kind. There are certain governmental and non-governmental organisations who educate the general public on how to make wise use of plastics and develop environment friendly habits. Find out organisations in your area which are carrying out awareness programmes. If there is none, form one.
2. Organise a debate in the school. Children may be given an option to role play as manufacturers of synthetic fabrics or those of fabrics from natural sources. They can then debate on the topic 'My Fabric is Superior'.
3. Visit five families in your neighbourhood and enquire about the kind of clothes they use, the reason for their choice and advantages of using them in terms of cost, durability and maintenance. Make a short report and submit it to your teacher.
4. Devise an activity to show that organic waste is biodegradable while plastic is not.

Did You Know?

Nylon appears like silk. It is strong and flexible. These endearing qualities of nylon created a public sensation, or nylon mania, when it was introduced in 1939. Women's stockings made from this new fibre were in great demand. But, unfortunately, most of the nylon production had to be diverted to making parachutes during the Second World War (1939-1945). After the war, when production of stockings resumed, supply did not match the demand. There was a huge black market for this product. Women had to wait for hours in queues to get a pair. Often there were nylon riots.



You are familiar with a number of materials like iron, aluminium, copper, etc. Some materials have been given in Table 4.1.

Table 4.1 : Appearance and Hardness of Materials

Object/ Material	Appearance (Shiny/Dull)	Hardness (Very hard/ Not very hard)
Iron		
Coal		
Sulphur		
Aluminium		
Copper		

Can you name the materials which are metals? The rest of the materials in Table 4.1 are non-metals. Metals can be distinguished from non-metals on the basis of their physical and chemical properties. Recall that lustre and hardness are physical properties.

4.1 Physical Properties of Metals and Non-metals

Have you ever seen a blacksmith beating an iron piece or an article made up of iron, like a spade, a shovel, an axe? Do you find a change in the shape of these articles on beating? Would you expect

a similar change if we try to beat a piece of coal ?

Let us find out.

Activity 4.1

Take a small iron nail, a coal piece, a piece of thick aluminium wire and a pencil lead. Beat the iron nail with a hammer (Fig. 4.1). *(But take care that you don't hurt yourself in the process.)* Try to hit hard. Hit hard



Fig. 4.1 : Beating an iron nail with hammer
the aluminium wire also. Then repeat the same kind of treatment on the coal piece and pencil lead. Record your observations in Table 4.2.

Table 4.2 : Malleability of Materials

Object/ Material	Change in Shape (Flattens/Breaks into pieces)
Iron nail	
Coal piece	
Aluminium wire	
Pencil lead	

You saw that the shape of the iron nail and the aluminium wire changed on beating. If they were beaten harder these could be changed into sheets. You might be familiar with silver foil used for decorating sweets. You must also be familiar with the aluminium foil used for wrapping food. The property of metals by which they can be beaten into thin sheets is called **malleability**. This is a characteristic property of metals. As you must have noticed, materials like coal and pencil lead do not show this property. Can we call these metals?

Can you hold a hot metallic pan which is without a plastic or a wooden handle and not get hurt? Perhaps not! Why? Try to list some other experiences in which a wooden or plastic handle protects you from being hurt while handling hot things. On the basis of these experiences what can you say about the conduction of heat by wood and plastic?

You must have seen an electrician using his screw driver. What kind of handle does it have? Why?

Let us find out.

Activity 4.2

Recall how to make an electric circuit to test whether electricity can pass through an object or not (Fig. 4.2). You might have performed



Fig. 4.2 : Electric tester

the activity with various objects in Class VI. Now, repeat the activity with the materials mentioned in Table 4.3. Observe and group these materials into good conductors and poor conductors.

Table 4.3 : Electrical Conductivity of Materials

S.No.	Materials	Good Conductor / Poor Conductor
1.	Iron rod/nail	
2.	Sulphur	
3.	Coal piece	
4.	Copper wire	

You observe that iron rod, nail and copper wire are good conductors while rolled sulphur piece and coal piece are poor conductors.



Oh! The meaning of recalling our experiences and then of this activity was to show that metals are good conductors of heat and electricity. We learnt this in Class VI.

Where do you find the use of aluminium and copper wires? Have you seen wires of coal? Definitely not!

The property of metal by which it can be drawn into wires is called **ductility**.

Have you ever noticed the difference in sound on dropping an iron sheet/plate, a metal coin, and a piece of coal on the floor? If not, you can try it now.

Do you note any difference in the sound produced?

Have you seen wooden bells in temples? Can you give a reason?

The things made of metals produce a ringing sound when struck hard. Suppose you have two boxes similar in appearance, one made of wood and the other of metal. Can you tell which box is made of metal by striking both the boxes?

Since metals produce ringing sounds, they are said to be **sonorous**. The materials other than metals are not sonorous.

After performing the above activities, we can say that some materials are **hard, lustrous, malleable, ductile, sonorous and good conductors of heat and electricity**. The materials which generally possess these properties are called metals. The examples of metals are iron, copper, aluminium, calcium, magnesium, etc. In contrast, materials like coal and sulphur are soft and dull in appearance. They break down into a powdery mass on tapping with a hammer. They are not sonorous and are poor conductors of heat and electricity. These materials are called **non-metals**. The examples of non-metals are sulphur, carbon, oxygen, phosphorus, etc.

Metals like sodium and potassium are soft and can be cut with a knife. Mercury is the only metal which is found in liquid state at room temperature. These are exceptions.

4.2 Chemical Properties of Metals and Non-metals

Reaction with Oxygen

You are familiar with the phenomenon of rusting of iron. Recall the reaction by

which rust is formed. You had also performed in Class VII an activity of burning a magnesium ribbon in air. You had learnt that in both the processes oxide formation takes place. Complete the following reactions of iron and magnesium with oxygen.

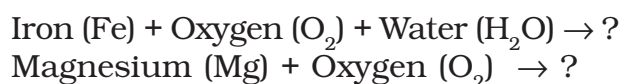

Activity 4.3

Let us check the nature of rust formed as a result of the reaction between iron, oxygen and water. Collect a spoonful of rust and dissolve it in a very little amount of water. You will find that the rust remains suspended in water. Shake the suspension well. Test the solution with red and blue litmus papers (Fig. 4.3). What do you observe? Is the solution acidic or basic?

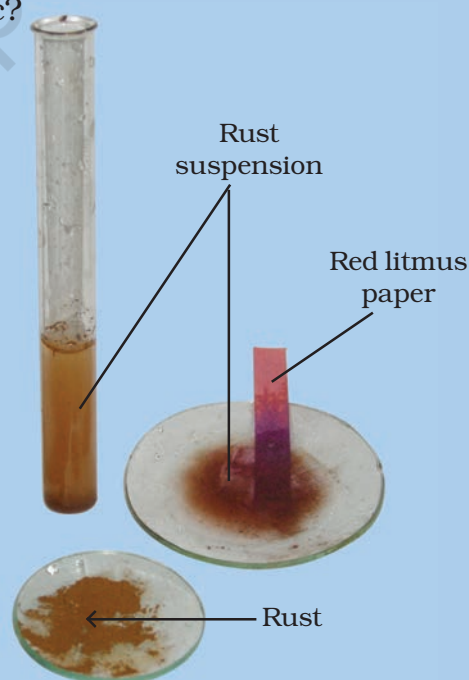

Fig. 4.3 : Testing the nature of rust

Does copper also get rusted? I have seen a greenish deposit on the surface of copper vessels.



When a copper vessel is exposed to moist air for long, it acquires a dull green coating. The green material is a mixture of copper hydroxide ($\text{Cu}(\text{OH})_2$) and copper carbonate (CuCO_3). The following is the reaction

$$2\text{Cu} + \underbrace{\text{H}_2\text{O} + \text{CO}_2 + \text{O}_2}_{\text{moist air}} \rightarrow \text{Cu}(\text{OH})_2 + \text{CuCO}_3$$

Now recall the activity of burning magnesium ribbon. The ash obtained on burning magnesium ribbon is dissolved in water and tested for its acidic/basic nature.

Is the solution acidic or basic? How do you ascertain this?

You must have observed that the red litmus turns blue. So, oxide of magnesium is also basic in nature. In general, metallic oxides are basic in nature.

Let us now observe the reaction of non-metals with oxygen.

Activity 4.4

(To be demonstrated by the teacher in the class)

Take a small amount of powdered sulphur in a deflagrating spoon and heat it. If deflagrating spoon is not available, you may take a metallic cap of any bottle and wrap a metallic wire around it and give it the shape shown in Fig. 4.4 (a).

As soon as sulphur starts burning, introduce the spoon into a gas jar/glass tumbler [Fig. 4.4 (a)]. Cover the tumbler with a lid to ensure that the gas produced does not escape. Remove the spoon after some time. Add a small quantity of water into the tumbler and quickly replace the lid. Shake the tumbler well. Check the solution with red and blue litmus papers [Fig. 4.4 (b)].



Fig. 4.4 (a) : Burning of sulphur powder

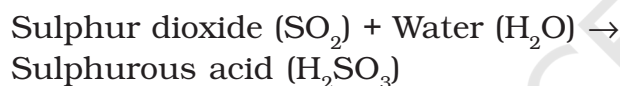

Fig. 4.4 (b) : Testing of solution with litmus papers

Table 4.4 : Metals and Non-metals in Acids and Bases

S.No.	Name of the Base	Metal	Name of the Acid	Non-metal
1.	Calcium hydroxide	Calcium	Sulphuric acid	Sulphur
2.				
3.				
4.				
5.				

The name of the product formed in the reaction of sulphur and oxygen is sulphur dioxide gas. When sulphur dioxide is dissolved in water sulphurous acid is formed. The reaction can be given as follows:



The sulphurous acid turns blue litmus paper red. Generally, oxides of non-metals are acidic in nature.

Recall the name of some of the laboratory acids and bases you have read in Class VII. Note down their names in Table 4.4. Identify the metal or non-metal present in them which forms oxides with oxygen.

Reaction with Water

Let us see how metals and non-metals react with water.

Sodium metal is very reactive. It reacts vigorously with oxygen and water. A lot of heat is generated in the reaction. It is, therefore, stored in kerosene.

Activity 4.5

(To be demonstrated by the teacher. During demonstration special care should be taken that the size of the sodium metal piece is roughly the size of a wheat grain. It should be held with a pair of tongs.)

Take a 250 mL beaker/glass tumbler. Fill half of it with water. Now carefully cut a small piece of sodium metal. Dry it using filter paper and wrap it in a small piece of cotton. Put the sodium piece wrapped in cotton into the beaker. Observe carefully. *(During observation keep away from the beaker)*. When reaction stops touch the beaker. What do you feel? Has the beaker become hot? Test the solution with red and blue litmus papers. Is the solution acidic or basic?



Fig. 4.5 : Reaction of sodium with water

You observed that sodium reacts vigorously with water. Some other metals do not do so. For example, iron reacts with water slowly.

Generally, non-metals do not react with water though they may be very reactive in air. Such non-metals are stored in water. For example,

phosphorus is a very reactive non-metal. It catches fire if exposed to air. To prevent the contact of phosphorus with atmospheric oxygen, it is stored in water.

Reactions with Acids

Let us see how metals and non-metals behave with acids.

Activity 4.6

(Warning : Keep the mouth of the test tube away from your face. Use test tube holder to hold the test tube.)

Take samples of metals and non-metals listed in Table 4.5 in separate test tubes and label them as A, B, C, D, E, and F. With the help of a dropper add 5 mL of dilute hydrochloric acid to each test tube one by one. Observe the reactions carefully. If no reaction occurs in the cold solution, warm the test tube gently. Bring a burning matchstick near the mouth of each test tube.

Repeat the same activity using dilute sulphuric acid instead of the dilute hydrochloric acid. Record your observations in Table 4.5.

Table 4.5 : Reaction of Metals and Non-metals with Acids

Test tube Label	Metal/ Non-metal	Reaction with Dilute Hydrochloric Acid		Reaction with Dilute Sulphuric Acid	
		Room Temperature	Warm	Room Temperature	Warm
A	Magnesium (ribbon)				
B	Aluminium (foil)				
C	Iron (filings)				
D	Copper (peeled flexible wire)				
E	Charcoal (powder)				
F	Sulphur (powder)				

Is there a difference in the way metals and non-metals react with acids? What could the 'pop' sound in some cases be due to when a burning match stick is brought near the mouth of the test tubes?

You must have found that non-metals generally do not react with acids but metals react with acids and produce hydrogen gas that burns with a 'pop' sound. You must have noticed that copper does not react with dilute hydrochloric acid even on heating but it reacts with sulphuric acid.

Reactions with Bases

Activity 4.7

(To be demonstrated by the teacher. During the preparation of sodium hydroxide solution, care should be taken that pellets of sodium hydroxide are handled with a plastic spatula).

Prepare a fresh solution of sodium hydroxide in a test tube by dissolving 3-4 pellets of it in 5 mL of water. Drop a piece of aluminium foil into it. Bring a burning match stick near the mouth of the test tube. Observe carefully.

What does the 'pop' sound indicate? As before, the 'pop' sound indicates the presence of hydrogen gas.

Metals react with sodium hydroxide to produce hydrogen gas.

Reactions of non-metals with bases are complex.

Displacement Reactions

Recall the activity of the reaction between copper sulphate and iron that you

performed in Class VII. Let us observe some more reactions of that kind.

Activity 4.8

Take five 100 mL beakers and label them A, B, C, D and E. Take about 50 mL of water in each beaker. Dissolve in each beaker a teaspoonful of each substance as indicated in Fig. 4.6 (a).

- Keep the beakers undisturbed for some time.
- Record your observations in your note book.

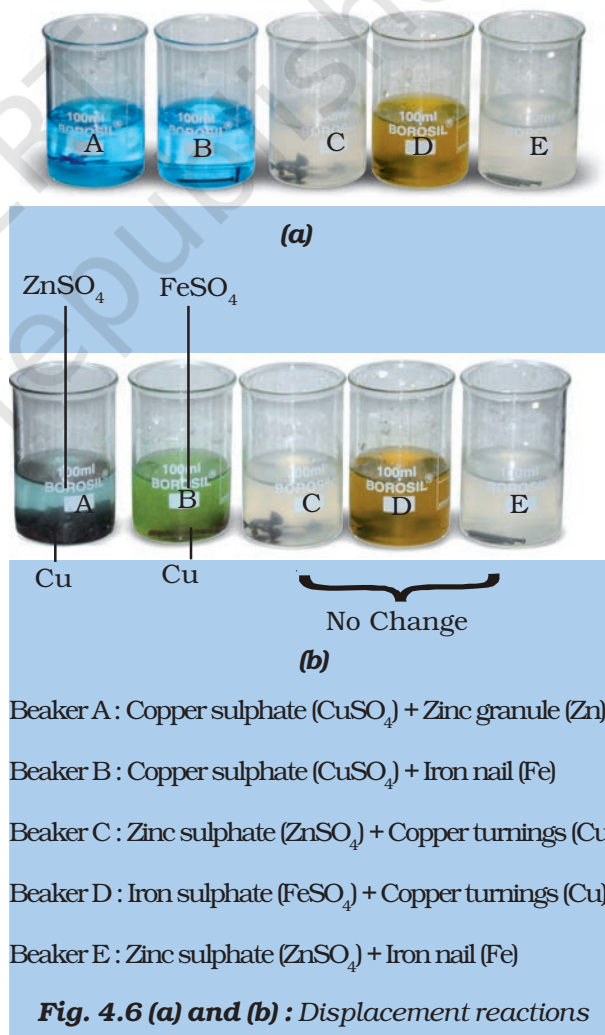

What changes do you observe in the various beakers? You have read that one metal displaces another metal from its compound in aqueous solution. In beaker 'A' zinc (Zn) replaces copper (Cu) from copper sulphate (CuSO_4). That is why the blue colour of copper sulphate disappears and a powdery red mass of copper is deposited at the bottom of the beaker. The reaction can be represented as follows:

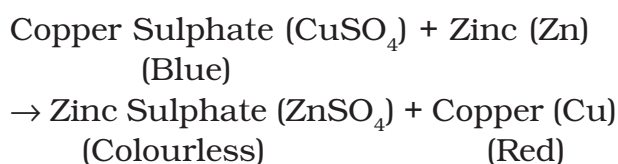

You can write down the reaction taking place in beaker 'B' in a similar manner.



I have understood the reactions taking place in beakers 'A' and 'B'. But I am still confused why there is no change in beakers 'C', 'D' and 'E'?

There could have been displacement of zinc by copper in beaker 'C' and by iron in beaker 'E'. Similarly iron could be displaced by copper in beaker 'D'.

Since we do not see any change in beaker C, we can infer that copper is not able to replace zinc from zinc sulphate. But why? When zinc can replace copper in beaker 'A' why cannot copper replace zinc in beaker 'C'? Remember that science is not

arbitrary. It follows definite rules based on facts. And the rule here is that zinc is more reactive than copper and iron. A more reactive metal can replace a less reactive metal, but a less reactive one cannot replace a more reactive metal. Now you can understand why there are no displacement reactions in beakers D and E also. Can you guess the sequence of metals from more reactive to less reactive among zinc, iron and copper?

4.3 Uses of Metals and Non-metals

You should be able to guess why metals are used in making machinery, automobiles, aeroplanes, trains, satellites, industrial gadgets, cooking utensils, water boilers, etc. You are also familiar with the uses of some non-metals. Here are some interesting ones. We are sure that you will guess them right:

- Non-metal is essential for our life which all living beings inhale during breathing,
- Non-metals used in fertilisers to enhance the growth of plants,
- Non-metal used in water purification process,
- Non-metal used in the purple coloured solution which is applied on wounds as an antiseptic,
- Non-metals used in crackers.

You may add some more uses of metals and non-metals from your experiences.



I heard that magnesium is found in plants. In what form is it found in them?



The doctor reported iron deficiency in my body. Where is iron in my body?

In Class VII, you have learnt that in a chemical reaction, new substances are formed. These substances are different from those which underwent the reaction. Now, if a substance cannot be broken down further by chemical reactions, by cooling, heating, or by electrolysis, it is called 'element'. Sulphur is an element. So is iron. Carbon, too, is an element. The smallest unit of an element is atom. A sample of an element contains only one kind of atom. The atom of an element remains unaffected by physical changes in the element. For example, an atom of liquid sulphur would be exactly the same as the atom of solid or vapour sulphur.

Although we have an infinite variety of substances in the universe, the number of elements forming these substances is limited. There are no more than 94 naturally occurring elements. An important classification of elements is in terms of metals and non-metals. Most of the elements are metals. The remaining are either non-metals or metalloids. Metalloids possess character of both metals and non-metals.

KEYWORDS

ATOM

CONDUCTOR

DISPLACEMENT
REACTION

DUCTILITY

ELEMENTS

HARDNESS

MALLEABILITY

METALS

METALLOIDS

NON-METALS

SONOROUS

WHAT YOU HAVE LEARNT

- Metals are lustrous whereas non-metals have no lustre.
- Generally, metals are malleable and ductile. Non-metals do not have these properties.
- Generally, metals are good conductors of heat and electricity but non-metals are poor conductors.
- On burning, metals react with oxygen to produce metal oxides which are basic in nature. Non-metals react with oxygen to produce non-metallic oxides which are acidic in nature.
- Some metals react with water to produce metal hydroxides and hydrogen gas. Generally, non-metals do not react with water.
- Metals react with acids and produce metal salts and hydrogen gas. Generally, non-metals do not react with acids.
- Some metals react with bases to produce hydrogen gas.
- More reactive metals displace less reactive metals from their compounds in aqueous solutions.
- Metals and non-metals are used widely in every day life.

Exercises

1. Which of the following can be beaten into thin sheets?
(a) Zinc (b) Phosphorus (c) Sulphur (d) Oxygen
2. Which of the following statements is correct?
(a) All metals are ductile.
(b) All non-metals are ductile.
(c) Generally, metals are ductile.
(d) Some non-metals are ductile.

3. Fill in the blanks.
- (a) Phosphorus is a very _____ non-metal.
- (b) Metals are _____ conductors of heat and _____.
- (c) Iron is _____ reactive than copper.
- (d) Metals react with acids to produce _____ gas.
4. Mark 'T' if the statement is true and 'F' if it is false.
- (a) Generally, non-metals react with acids. ()
- (b) Sodium is a very reactive metal. ()
- (c) Copper displaces zinc from zinc sulphate solution. ()
- (d) Coal can be drawn into wires. ()
5. Some properties are listed in the following Table. Distinguish between metals and non-metals on the basis of these properties.

Properties	Metals	Non-metals
1. Appearance		
2. Hardness		
3. Malleability		
4. Ductility		
5. Heat Conduction		
6. Conduction of Electricity		

6. Give reasons for the following.
- (a) Aluminium foils are used to wrap food items.
- (b) Immersion rods for heating liquids are made up of metallic substances.
- (c) Copper cannot displace zinc from its salt solution.
- (d) Sodium and potassium are stored in kerosene.
7. Can you store lemon pickle in an aluminium utensil? Explain.
8. Match the substances given in Column **A** with their uses given in Column **B**.

A	B
(i) Gold	(a) Thermometers
(ii) Iron	(b) Electric wire
(iii) Aluminium	(c) Wrapping food
(iv) Carbon	(d) Jewellery
(v) Copper	(e) Machinery
(vi) Mercury	(f) Fuel

9. What happens when
- Dilute sulphuric acid is poured on a copper plate?
 - Iron nails are placed in copper sulphate solution?
- Write word equations of the reactions involved.
10. Saloni took a piece of burning charcoal and collected the gas evolved in a test tube.
- How will she find the nature of the gas ?
 - Write down word equations of all the reactions taking place in this process.
11. One day Reeta went to a jeweller's shop with her mother. Her mother gave an old gold jewellery to the goldsmith to polish. Next day when they brought the jewellery back, they found that there was a slight loss in its weight. Can you suggest a reason for the loss in weight?

Extended Learning — Activities and Projects

- Prepare Index Cards for any four metals and four non-metals. The card should have information like name of metal/non-metal; its physical properties, chemical properties and its uses.
- Visit a blacksmith and observe how metals are moulded.
- Suggest an experiment to compare the conductivity of electricity by iron, copper, aluminium and zinc. Perform the experiment and prepare a short report on the results.
- Find out the locations of the deposits of iron, aluminium and zinc in India. Mark these in an outline map of India. In which form are the deposits found? Discuss in the class.
- Discuss with your parents/neighbours/goldsmiths why gold is preferred for making jewellery.
- Visit the following websites and enjoy the quiz on metals and non-metals:
 - chemistry.about.com/od/testsquizzes/Chemistry_Tests_Quizzes.htm
 - www.gcsescience.com/q/qusemet.html
 - www.corrosionsource.com/handbook/periodic/metals.htm



We use various materials for our basic needs. Some of them are found in nature and some have been made by human efforts.

Activity 5.1

Make a list of various materials used by us in daily life and classify them as natural and man-made.

Natural	Man-made

Does this list include air, water, soil and minerals? Since all these are obtained from nature, they are called natural resources.



Can we use all our natural resources forever ?

Can air, water and soil be exhausted by human activities? You have already studied about water in Class VII. Is water a limitless resource?

In the light of the availability of various resources in nature, natural resources can be broadly classified into two kinds:

(i) Inexhaustible Natural Resources:

These resources are present in unlimited quantity in nature and are not likely to be exhausted by human activities. Examples are: sunlight, air.

(ii) Exhaustible Natural Resources:

The amount of these resources in nature is limited. They can be exhausted by human activities. Examples of these resources are forests, wildlife, minerals, coal, petroleum, natural gas etc.

Activity 5.2

(It is a group activity)

Take some containers. Fill them with popcorn/peanuts/roasted gram/toffees. Divide students into groups of seven each. Further divide each group into three subgroups containing 1, 2 and 4 students. Label them as first, second and third generation respectively.

These sub-groups represent the consumers. As population is growing, second and third generations have larger number of consumers.

Put one full container for each group on a table. Ask consumers of the first generation from each group to consume eatables from the container of their group. Now, ask the second generation consumers from each group to do the same. Ask students to observe carefully the availability of eatables in each container. If some thing is left in the containers, ask third generation from each group to consume it. Now, finally observe whether all the consumers of the third generation got the eatables or not. Also observe if anything is still left in any of the containers.

Assume that the eatables in the container represent the total availability of an exhaustible natural resource like coal, petroleum or natural gas. Each group may have a different consumption pattern. Are the earlier generations of any group too greedy? It may be that the earlier generations in some groups were concerned about the coming generation(s) and left something for them.

In this chapter we will learn about some exhaustible natural resources like coal, petroleum and natural gas. These were formed from the dead remains of living organisms (fossils). So, these are all known as **fossil fuels**.

5.1 Coal

You may have seen coal or heard about it (Fig. 5.1). It is as hard as stone and is black in colour.



Fig. 5.1: Coal

Coal is one of the fuels used to cook food. Earlier, it was used in railway engines to produce steam to run the engine. It is also used in thermal power plants to produce electricity. Coal is also used as a fuel in various industries.

Story of Coal

Where do we get coal from and how is it formed?



About 300 million years ago the earth had dense forests in low lying wetland areas. Due to natural processes, like flooding, these forests got buried under the soil. As more soil deposited over them, they were compressed. The temperature also rose as they sank deeper and deeper. Under high pressure and high temperature, dead plants got slowly converted to coal. As coal contains mainly carbon, the slow process of conversion of dead vegetation into coal is called carbonisation. Since it was formed from the remains of vegetation, coal is also called a fossil fuel. A coal mine is shown in Fig. 5.2.



Fig. 5.2: A coal mine

When heated in air, coal burns and produces mainly carbon dioxide gas.

Coal is processed in industry to get some useful products such as coke, coal tar and coal gas.

Coke

It is a tough, porous and black substance. It is an almost pure form of carbon. Coke is used in the manufacture of steel and in the extraction of many metals.

Coal Tar

It is a black, thick liquid (Fig. 5.3) with an unpleasant smell. It is a mixture of



Fig. 5.3: Coal tar

about 200 substances. Products obtained from coal tar are used as starting materials for manufacturing various substances used in everyday life and in industry, like synthetic dyes, drugs, explosives, perfumes, plastics, paints, photographic materials, roofing materials, etc. Interestingly, naphthalene balls used to repel moths and other insects are also obtained from coal tar.

These days, bitumen, a petroleum product, is used in place of coal-tar for metalling the roads.

Coal Gas

Coal gas is obtained during the processing of coal to get coke. It is used

Coal gas was used for street lighting for the first time in London in 1810 and in New York around 1820. Now a days, it is used as a source of heat rather than light.

as a fuel in many industries situated near the coal processing plants.

5.2 Petroleum

You know that petrol is used as a fuel in light automobiles such as motor cycles/scooters and cars. Heavy motor vehicles like trucks and tractors run on diesel. Petrol and diesel are obtained from a natural resource called **petroleum**. The word petroleum is derived from *petra* (rock) and *oleum* (oil) as it is mined from between the rocks under Earth as shown in Fig. 5.4.

Do you know how petroleum is formed?

Petroleum was formed from organisms living in the sea. As these organisms died, their bodies settled at the bottom of the sea and got covered with layers of sand and clay. Over millions of years, absence of air, high temperature and high pressure

transformed the dead organisms into petroleum and natural gas.

Look at Fig. 5.4. It shows the deposits of petroleum and natural gas. You see that the layer containing petroleum oil and gas is above that of water. Why is it so? Recall that oil and gas are lighter than water and do not mix with it.

The world's first oil well was drilled in Pennsylvania, USA, in 1859. Eight years later, in 1867, oil was struck at Makum in Assam. In India, oil is found in Assam, Gujarat, Mumbai High and in the river basins of Godavari and Krishna.

Refining of Petroleum

Petroleum is a dark oily liquid. It has an unpleasant odour. It is a mixture of various constituents such as petroleum gas, petrol, diesel, lubricating oil, paraffin wax, etc. The process of

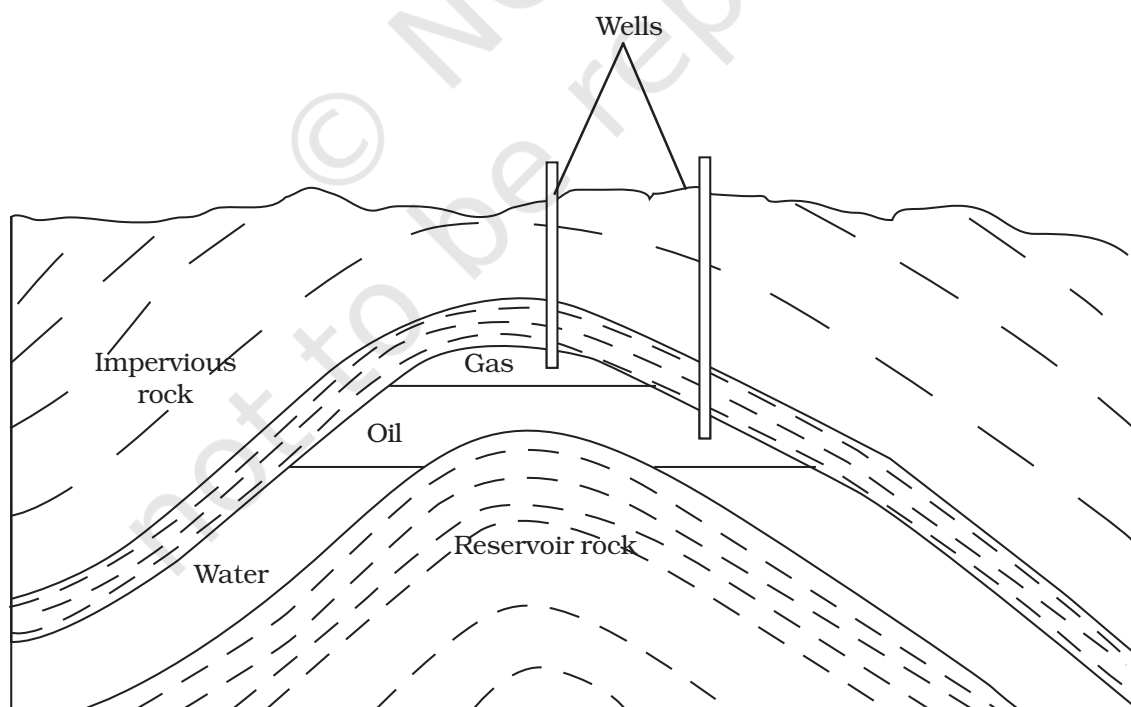

Fig. 5.4 : Petroleum and natural gas deposits



Fig. 5.5: A petroleum refinery

separating the various constituents/fractions of petroleum is known as refining. It is carried out in a **petroleum refinery** (Fig. 5.5).

Various constituents of petroleum and their uses are given in Table 5.1.

Many useful substances are obtained from petroleum and natural gas. These are termed as 'Petrochemicals'. These are used in the manufacture of detergents, fibres (polyester, nylon, acrylic etc.), polythene and other man-made plastics. Hydrogen gas obtained from natural gas, is used in the production of fertilisers (urea). Due to its great commercial importance, petroleum is also called 'black gold'.

5.3 Natural Gas

Natural gas is a very important fossil fuel because it is easy to transport through pipes. Natural gas is stored under high pressure as compressed natural gas (CNG). CNG is used for power generation. It is now being used

Table 5.1 Various Constituents of Petroleum and their Uses

S.No.	Constituents of Petroleum	Uses
1.	Petroleum Gas in Liquid form (LPG)	Fuel for home and industry
2.	Petrol	Motor fuel, aviation fuel, solvent for dry cleaning
3.	Kerosene	Fuel for stoves, lamps and for jet aircrafts
4.	Diesel	Fuel for heavy motor vehicles, electric generators
5.	Lubricating oil	Lubrication
6.	Paraffin wax	Ointments, candles, vaseline etc.
7.	Bitumen	Paints, road surfacing

as a fuel for transport vehicles because it is less polluting. It is a cleaner fuel.

The great advantage of CNG is that it can be used directly for burning in homes and factories where it can be supplied through pipes. Such a network of pipelines exists in Vadodara (Gujarat), some parts of Delhi and other places.

Natural gas is also used as a starting material for the manufacture of a number of chemicals and fertilisers. India has vast reserves of natural gas. In our country, natural gas has been found in Tripura, Rajasthan, Maharashtra and in the Krishna Godavari delta.



Can coal, petroleum and natural gas be prepared in the laboratory from dead organisms?



No. Their formation is a very slow process and conditions for their formation cannot be created in the laboratory.

5.4 Some Natural Resources are Limited

You have studied in the beginning of the chapter that some natural resources are exhaustible like fossil fuels, forests, minerals etc.

You know that coal and petroleum are fossil fuels. It required the dead organisms millions of years to get converted into these fuels. On the other hand, the known reserves of these will last only a few hundred years. Moreover, burning of these fuels is a major cause of air pollution. Their use is also linked to global warming. It is therefore necessary that we use these fuels only when absolutely necessary. This will result in better environment, smaller risk of global warming and their availability for a longer period of time.

In India, the Petroleum Conservation Research Association (PCRA) advises people how to save petrol/diesel while driving. Their tips are

- drive at a constant and moderate speed as far as possible,
- switch off the engine at traffic lights or at a place where you have to wait,
- ensure correct tyre pressure.
- ensure regular maintenance of the vehicle.

KEYWORDS

COAL

COAL GAS

COAL TAR

COKE

FOSSIL FUEL

NATURAL GAS

PETROLEUM

PETROLEUM
REFINERY

WHAT YOU HAVE LEARNT

- Coal, petroleum and natural gas are fossil fuels.
- Fossil fuels were formed from the dead remains of living organisms millions of years ago.
- Fossil fuels are exhaustible resources.
- Coke, coal tar and coal gas are the products of coal.
- Petroleum gas, petrol, diesel, kerosene, paraffin wax, lubricating oil are obtained by refining petroleum.
- Coal and petroleum resources are limited. We should use them judiciously.

Exercises

1. What are the advantages of using CNG and LPG as fuels?
2. Name the petroleum product used for surfacing of roads.
3. Describe how coal is formed from dead vegetation. What is this process called?
4. Fill in the blanks.
 - (a) Fossil fuels are _____, _____ and _____.
 - (b) Process of separation of different constituents from petroleum is called _____.
 - (c) Least polluting fuel for vehicle is _____.
5. Tick True/False against the following statements.
 - (a) Fossil fuels can be made in the laboratory. (T/F)
 - (b) CNG is more polluting fuel than petrol. (T/F)
 - (c) Coke is almost pure form of carbon. (T/F)
 - (d) Coal tar is a mixture of various substances. (T/F)
 - (e) Kerosene is not a fossil fuel. (T/F)
6. Explain why fossil fuels are exhaustible natural resources.

7. Describe characteristics and uses of coke.
8. Explain the process of formation of petroleum.
9. The following Table shows the total power shortage in India from 1991–1997. Show the data in the form of a graph. Plot shortage percentage for the years on the Y-axis and the year on the X-axis.

S. No.	Year	Shortage (%)
1	1991	7.9
2	1992	7.8
3	1993	8.3
4	1994	7.4
5	1995	7.1
6	1996	9.2
7	1997	11.5

Extended Learning — Activities and Projects

1. Get an outline map of India. Mark the places in the map where coal, petroleum and natural gas are found. Show the places where petroleum refineries are situated.
2. Choose any five families of your neighbourhood. Enquire whether their energy consumption (coal, gas, electricity, petrol, kerosene) has increased or decreased in the last five years. Enquire also about the measures they adopt to conserve energy.
3. Find out the location of major thermal power plants in India. What could be the reasons for their being located at those places?

For more information, visit:

- www.energyarchive.ca.gov
- web.ccsd.k12.wy.us
- web.pcra.org



We use different kinds of fuel for various purposes at home, in industry and for running automobiles. Can you name a few fuels used in our homes? Name a few fuels used in trade and industry. What fuels are used for running automobiles? Your list will contain fuels like cowdung, wood, coal, charcoal, petrol, diesel, compressed natural gas (CNG), etc.

You are familiar with the burning of a candle. What is the difference between the burning of a candle and the burning of a fuel like coal? May be you were able to guess right: candle burns with a flame whereas coal does not. Similarly, you will find many other materials burning without a flame. Let us study the chemical process of burning and the types of flame produced during this process.

6.1 What is Combustion?

Recall the activity of burning of magnesium ribbon performed in Class VII. We learnt that magnesium burns to form magnesium oxide and produces heat and light (Fig. 6.1).

We can perform a similar activity with a piece of charcoal. Hold the piece with a pair of tongs and bring it near the flame of a candle or a Bunsen burner. What do you observe?

We find that charcoal burns in air. We know that coal, too, burns in air producing carbon dioxide, heat and light.



Fig. 6.1 : Burning of magnesium

A chemical process in which a substance reacts with oxygen to give off heat is called **combustion**. The substance that undergoes combustion is said to be combustible. It is also called a **fuel**. The fuel may be solid, liquid or gas. Sometimes, light is also given off during combustion, either as a flame or as a glow.

In the reactions mentioned above magnesium and charcoal are combustible substances.



We were told that food is a fuel for our body.

Rightly so. In our body food is broken down by reaction with oxygen and heat is produced. We learnt that in Class VII.



Activity 6.1

Collect some materials like straw, matchsticks, kerosene oil, paper, iron nails, stone pieces, glass etc.

Under the supervision of your teacher try to burn each of these materials one by one. If combustion takes place mark the material **combustible**, otherwise mark it **non-combustible** (Table 6.1).

Table 6.1 : Combustible and Non-combustible Substances

Material	Combustible	Non-combustible
Wood		
Paper		
Iron nails		
Kerosene oil		
Stone piece		
Straw		
Charcoal		
Matchsticks		
Glass		

Can you name some more substances which are combustible? You can add those to Table 6.1.

Let us investigate conditions under which combustion takes place.

Activity 6.2

(Caution : Be careful while handling burning candle).

Fix a lighted candle on a table. Put a glass chimney over the candle and rest it on a few wooden blocks in such a way that air can enter the

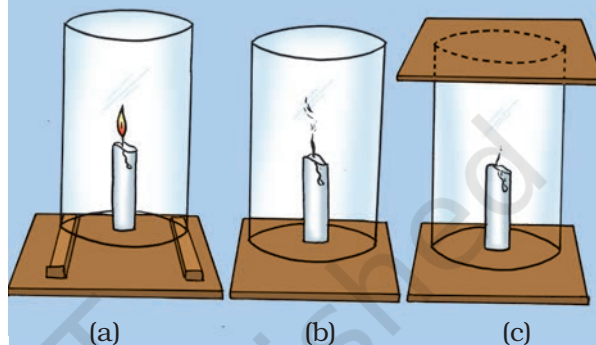

Fig. 6.2: Experiment to show that air is essential for burning

chimney [Fig. 6.2(a)]. Observe what happens to the flame. Now remove the blocks and let the chimney rest on the table [Fig. 6.2(b)]. Again observe the flame. Finally, put a glass plate over the chimney [Fig. 6.2(c)]. Watch the flame again. What happens in the three cases? Does the flame flicker off? Does it flicker and give smoke? Does it burn unaffected? Can you infer anything at all about the role played by air in the process of burning?

We find that for combustion, air is necessary. The candle burns freely in case (a) when air can enter the chimney from below. In case (b), when air does not enter the chimney from below, the flame flickers and produces smoke. In case (c), the flame finally goes off because the air is not available.



We have read that the sun produces its own heat and light. Is it also some kind of combustion?

In the sun, heat and light are produced by nuclear reactions. You will learn about this process in higher classes.

Activity 6.3

Place a piece of burning wood or charcoal on an iron plate or *Tawa*. Cover it with a glass jar or a tumbler, or a transparent plastic jar. Observe what happens. Does charcoal stop burning after sometime? Can you think of the reason why it stops burning?

You might have heard that when the clothes of a person catch fire, the person

is covered with a blanket to extinguish fire (Fig. 6.3). Can you guess why?



Fig. 6.3 : Blanket wrapped around a person whose clothes caught fire

Now recall some of your experiences.

Does a matchstick burn by itself? How does it burn?

You must have had an experience of burning a piece of paper. Does it burn when a burning matchstick is brought near it?

Can you burn a piece of wood by bringing a lighted matchstick near it?

Why do you have to use paper or kerosene oil to start fire in wood or coal?

Have you heard of forest fires?

During extreme heat of summer, at some places dry grass catches fire. From the grass, it spreads to trees, and very soon the whole forest is on fire (Fig. 6.4). It is very difficult to control such fires.



Fig. 6.4 : Forest fire

Do these experiences tell you that different substances catch fire at different temperatures?

The lowest temperature at which a substance catches fire is called its **ignition temperature**.

Can you tell now why a matchstick does not catch fire on its own at room temperature? Why does the matchstick start burning on rubbing it on the side of the matchbox?

The history of the matchstick is very old. More than five thousand years ago small pieces of pinewood dipped in sulphur were used as matches in ancient Egypt. The modern safety match was developed only about two hundred years ago.

A mixture of antimony trisulphide, potassium chlorate and white phosphorus with some glue and starch was applied on the head of a match made of suitable wood. When struck against a rough surface, white phosphorus got ignited due to the heat of friction. This started the combustion of the match. However, white phosphorus proved to be dangerous both for the workers involved in the manufacturing of matches and for the users.

These days the head of the safety match contains only antimony trisulphide and potassium chlorate. The rubbing surface has powdered glass and a little red phosphorus (which is much less dangerous). When the match is struck against the rubbing surface, some red phosphorus gets converted into white phosphorus. This immediately reacts with potassium chlorate in the matchstick head to produce enough heat to ignite antimony trisulphide and start the combustion.

We find that a combustible substance cannot catch fire or burn as long as its temperature is lower than its ignition temperature. Have you ever seen cooking oil catching fire when a frying pan is kept for long on a burning stove? Kerosene oil and wood do not catch fire on their own at room temperature. But, if kerosene oil is heated a little, it will catch fire. But if wood is heated a little, it would still not catch fire. Does it mean that ignition temperature of kerosene oil is lower than that of wood? Does it mean that we need to take special care in storing kerosene oil? The following activity shows that it is essential for a substance to reach ignition temperature to burn.

Activity 6.4

(Caution : Be careful while handling burning candle).

Make two paper cups by folding a sheet of paper. Pour about 50 mL of water in one of the cups. Heat both the cups separately with a candle (Fig. 6.5). What do you observe?

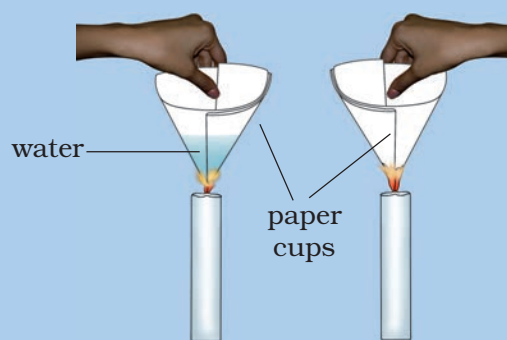

Fig. 6.5 : Heating water in a paper cup

What happens to the empty paper cup? What happens to the paper cup with water? Does water in this cup become hot?

If we continue heating the cup, we can even boil water in the paper cup.

Can you think of an explanation for this phenomenon?

The heat supplied to the paper cup is transferred to water by conduction. So, in the presence of water, the ignition temperature of paper is not reached. Hence, it does not burn.

The substances which have very low ignition temperature and can easily catch fire with a flame are called **inflammable substances**. Examples of inflammable substances are petrol, alcohol, Liquefied Petroleum Gas (LPG) etc. Can you list some more inflammable substances?

6.2 How Do We Control Fire?

You must have seen or heard of fire breaking out in homes, shops and factories. If you have seen such an accident, write a short description in your note book. Also, share the experience with your classmates.

Find out the telephone number of the fire service in your area. If a fire breaks out in your house or in your neighbourhood, the first thing to do is to call the fire service.



It is important that all of us know the telephone numbers of the fire service.



Fig. 6.6: Firemen extinguish the fire by throwing water under pressure

Does your city/town have a fire brigade station?

When a fire brigade arrives, what does it do? It pours water on the fire (Fig. 6.6). Water cools the combustible material so that its temperature is brought below its ignition temperature. This prevents the fire from spreading. Water vapours also surround the combustible material, helping in cutting off the supply of air. So, the fire is extinguished.

You have learnt that there are three essential requirements for producing fire. Can you list these requirements?

These are: fuel, air (to supply oxygen) and heat (to raise the temperature of the fuel beyond the ignition temperature). Fire can be controlled by removing one or more of these requirements. The job of a fire extinguisher is to cut off the supply of air, or to bring down the temperature of the fuel, or both. Notice that the fuel

The most common fire extinguisher is water. But water works only when things like wood and paper are on fire. If electrical equipment is on fire, water may conduct electricity and harm those trying to douse the fire. Water is also not suitable for fires involving oil and petrol. Do you recall that water is heavier than oil? So, it sinks below the oil, and oil keeps burning on the top.



Fig. 6.7 : Fire extinguisher

For fires involving electrical equipment and inflammable materials like petrol, carbon dioxide (CO_2) is the best extinguisher. CO_2 , being heavier than oxygen, covers the fire like a blanket. Since the contact between the fuel and oxygen is cut off, the fire is controlled. The added advantage of CO_2 is that in most cases it does not harm the electrical equipment.

How do we get the supply of carbon dioxide? It can be stored at high pressure as a liquid in cylinders. In what form is the LPG stored in cylinders? When released from the cylinder, CO_2 expands enormously in volume and cools down. So, it not only forms a blanket around the fire, it also brings down the temperature of the fuel. That is why it is an excellent fire extinguisher. Another way to get CO_2 is to release a lot of dry powder of chemicals like sodium bicarbonate (baking soda) or potassium bicarbonate. Near the fire, these chemicals give off CO_2 .

in most cases cannot be eliminated. If, for instance, a building catches fire, the whole building is the fuel.

6.3 Types of Combustion

Bring a burning matchstick or a gas lighter near a gas stove in the kitchen. Turn on the knob of the gas stove. What do you observe?

CAUTION : Do not handle the gas stove yourself. Ask your parents to help.

We find that the gas burns rapidly and produces heat and light. Such combustion is known as **rapid combustion**.

There are substances like phosphorus which burn in air at room temperature.

The type of combustion in which a material suddenly bursts into flames, without the application of any apparent cause is called **spontaneous combustion**.

Spontaneous combustion of coal dust has resulted in many disastrous fires in coal mines. Spontaneous forest fires are sometimes due to the heat of the sun or due to lightning strike. However, most forest fires are due to the carelessness of human beings. It is important to remember that the campfires must be completely extinguished before leaving a forest after a picnic, or a visit.



Fig. 6.8: Colours of a candle flame and the flame of a kitchen stove

We generally have fireworks on festival days. When a cracker is ignited, a sudden reaction takes place with the evolution of heat, light and sound. A large amount of gas formed in the reaction is liberated. Such a reaction is called **explosion**. Explosion can also take place if pressure is applied on the cracker.

6.4 Flame

Observe an LPG flame. Can you tell the colour of the flame. What is the colour of a candle flame?

Recall your experience of burning a magnesium ribbon in Class VII. If you do not have experience of burning the remaining items in Table 6.2 you can do that now.



Fig. 6.9 : Flames of kerosene lamp, candle and Bunsen burner

Record your observations and mention whether on burning the material forms a flame or not.

Table 6.2 Materials forming Flame on Burning

S.No.	Material	Forms flame	Does not form flame
1.	Candle		
2.	Magnesium		
3.	Camphor		
4.	Kerosene Stove		
5.	Charcoal		

6.5 Structure of a Flame

Activity 6.5

Light a candle (*Caution : Be careful*). Hold a 4–5 cm long thin glass tube with a pair of tongs and introduce its one end in the dark zone of a non-flickering candle flame (Fig. 6.10). Bring a lighted matchstick near the other end of the glass tube. Do you see a flame caught at this end of the glass tube after a while? If so, what is it that produces a flame? Notice that the wax near the heated wick melts quickly.



Fig. 6.10

The substances which vapourise during burning, give flames. For example, kerosene oil and molten wax rise through the wick and are vapourised during burning and form flames. Charcoal, on the other hand, does not vapourise and so does not produce a flame. In Activity 6.5, could the vapours of wax coming out of the glass tube be the cause of the flame produced?

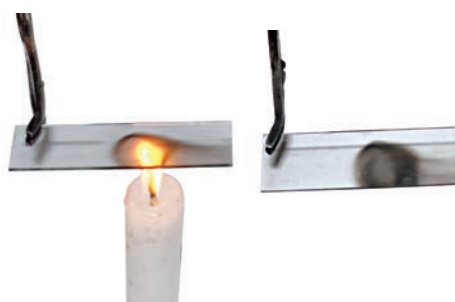

Fig. 6.11

When the candle flame is steady, introduce a clean glass plate/slide into the luminous zone of the flame (Fig. 6.11). Hold it there with a pair of tongs for about 10 seconds. Then remove it. What do you observe?



Fig. 6.12

A circular blackish ring is formed on the glass plate/slide. It indicates the deposition of unburnt carbon particles present in the luminous zone of the flame.

Hold a thin long copper wire just inside the non-luminous zone of flame for about 30 seconds (Fig. 6.12).

Notice that the portion of the copper wire just outside the flame gets red hot. Does it indicate that the non-luminous zone of the flame has a high

temperature? In fact, this part of the flame is the hottest part (Fig. 6.13).

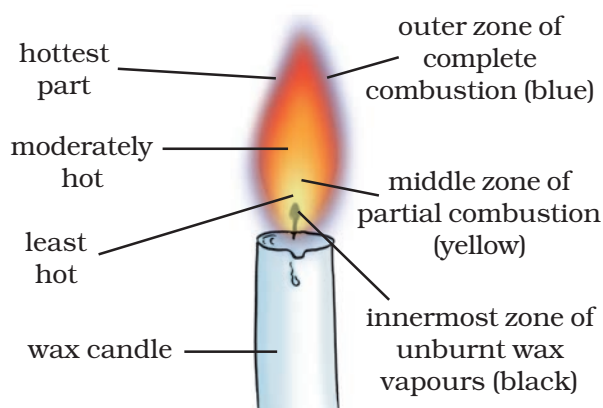

Fig. 6.13 : Different zones of candle flame

Goldsmiths blow the outermost zone of a flame with a metallic blow-pipe for melting gold and silver (Fig. 6.14). Why do they use the outermost zone of the flame?



Fig. 6.14 : Goldsmith blowing through a metallic pipe

6.6 What is a Fuel?

Recall that the sources of heat energy for domestic and industrial purposes are mainly wood, charcoal, petrol, kerosene etc. These substances are called **fuels**. A good fuel is one which is readily available. It is cheap. It burns easily in air at a moderate rate. It produces a large amount of heat. It does not leave behind any undesirable substances.

There is probably no fuel that could be considered as an **ideal fuel**. We should look for a fuel which fulfils most of the requirements for a particular use.

Fuels differ in their cost. Some fuels are cheaper than others.

Make a list of fuels familiar to you. Group them as solid, liquid and gaseous fuels as in Table 6.3.

6.7 Fuel Efficiency

Suppose you were asked to boil a given quantity of water using cow dung, coal and LPG as fuel. Which fuel would you prefer? Give your reason. You may take the help of your parents. Do these three fuels produce the same amount of heat? The amount of heat energy produced on complete combustion of 1 kg of a fuel is called its **calorific value**. The calorific value of a fuel is expressed in a unit

Table 6.3 : Types of Fuels

S. No.	Solid Fuels	Liquid Fuels	Gaseous Fuels
1.	Coal	Kerosene oil	Natural gas
2.			
3.			

called **kilojoule per kg** (kJ/kg). Calorific values of some fuels are given in Table 6.4.

Table 6.4 : Calorific Values of different Fuels

Fuel	Calorific Value (kJ/kg)
Cow dung cake	6000-8000
Wood	17000-22000
Coal	25000-33000
Petrol	45000
Kerosene	45000
Diesel	45000
Methane	50000
CNG	50000
LPG	55000
Biogas	35000-40000
Hydrogen	150000

Burning of Fuels Leads to Harmful Products

The increasing fuel consumption has harmful effects on the environment.

1. Carbon fuels like wood, coal, petroleum release unburnt carbon

For centuries, wood was used as domestic and industrial fuel. But now it has been replaced by coal and other fuels like LPG. In many rural parts of our country, people still use wood as a fuel because of its easy availability and low cost. However, burning of wood gives a lot of smoke which is very harmful for human beings. It causes respiratory problem. Also, trees provide us with useful substances which are lost when wood is used as fuel. Moreover cutting of trees leads to **deforestation** which is quite harmful to the environment, as you learnt in Class VII.

particles. These fine particles are dangerous pollutants causing respiratory diseases, such as asthma.

2. Incomplete combustion of these fuels gives carbon monoxide gas. It is a very poisonous gas. It is dangerous to burn coal in a closed room. The carbon monoxide gas produced can kill persons sleeping in that room.

Oh! So, that is why we are advised never to sleep in a room with burning or smouldering coal fire in it.



3. Combustion of most fuels releases carbon dioxide in the environment. Increased concentration of carbon dioxide in the air is believed to cause **global warming**.

Global warming is the rise in temperature of the atmosphere of the earth. This results, among other things, in the melting of polar glaciers, which leads to a rise in the sea level, causing floods in the coastal areas. Low lying coastal areas may even be permanently submerged under water.

4. Burning of coal and diesel releases sulphur dioxide gas. It is an extremely suffocating and corrosive gas. Moreover, petrol engines give off gaseous oxides of nitrogen. Oxides of sulphur and nitrogen dissolve in rain water and form acids. Such rain is called **acid rain**. It is very harmful for crops, buildings and soil. You have already learnt about it in Class VII.

The use of diesel and petrol as fuels in automobiles is being replaced by CNG (Compressed Natural Gas), because CNG produces the harmful products in very small amounts. CNG is a cleaner fuel.

KEYWORDS

ACID RAIN

CALORIFIC VALUE

COMBUSTION

DEFORESTATION

EXPLOSION

FLAME

FIRE EXTINGUISHER

FUEL

FUEL EFFICIENCY

GLOBAL WARMING

IDEAL FUEL

IGNITION
TEMPERATURE

INFLAMMABLE
SUBSTANCES

WHAT YOU HAVE LEARNT

- The substances which burn in air are called combustible.
- Oxygen (in air) is essential for combustion.
- During the process of combustion, heat and light are given out.
- Ignition temperature is the lowest temperature at which a combustible substance catches fire.
- Inflammable substances have very low ignition temperature.
- Fire can be controlled by removing one or more requirements essential for producing fire.
- Water is commonly used to control fires.
- Water cannot be used to control fires involving electrical equipment or oils.
- There are various types of combustions such as rapid combustion, spontaneous combustion, explosion, etc.
- There are three different zones of a flame - dark zone, luminous zone and non-luminous zone.
- An ideal fuel is cheap, readily available, readily combustible and easy to transport. It has high calorific value. It does not produce gases or residues that pollute the environment.
- Fuels differ in their efficiency and cost.
- Fuel efficiency is expressed in terms of its calorific value which is expressed in units of kilojoule per kg.
- Unburnt carbon particles in air are dangerous pollutants causing respiratory problems.
- Incomplete combustion of a fuel gives poisonous carbon monoxide gas.
- Increased percentage of carbon dioxide in air has been linked to global warming.
- Oxides of sulphur and nitrogen produced by the burning of coal, diesel and petrol cause acid rain which is harmful for crops, buildings and soil.

Exercises

- List conditions under which combustion can take place.
- Fill in the blanks.
 - Burning of wood and coal causes _____ of air.
 - A liquid fuel, used in homes is _____.
 - Fuel must be heated to its _____ before it starts burning.
 - Fire produced by oil cannot be controlled by _____.
- Explain how the use of CNG in automobiles has reduced pollution in our cities.
- Compare LPG and wood as fuels.
- Give reasons.
 - Water is not used to control fires involving electrical equipment.
 - LPG is a better domestic fuel than wood.
 - Paper by itself catches fire easily whereas a piece of paper wrapped around an aluminium pipe does not.
- Make a labelled diagram of a candle flame.
- Name the unit in which the calorific value of a fuel is expressed.
- Explain how CO_2 is able to control fires.
- It is difficult to burn a heap of green leaves but dry leaves catch fire easily. Explain.
- Which zone of a flame does a goldsmith use for melting gold and silver and why?
- In an experiment 4.5 kg of a fuel was completely burnt. The heat produced was measured to be 180,000 kJ. Calculate the calorific value of the fuel.
- Can the process of rusting be called combustion? Discuss.
- Abida and Ramesh were doing an experiment in which water was to be heated in a beaker. Abida kept the beaker near the wick in the yellow part of the candle flame. Ramesh kept the beaker in the outermost part of the flame. Whose water will get heated in a shorter time?

Extended Learning — Activities and Projects

1. Survey the availability of various fuels in your locality. Find out their cost per kg and prepare a tabular chart showing how many kJ of various fuels you can get for every rupee.
2. Find out the number, type and location of fire extinguishers available in your school, nearby shops and factories. Write a brief report about the preparedness of these establishments to fight fire.
3. Survey 100 houses in your area. Find the percentage of households using LPG, kerosene, wood and cattle dung as fuel.
4. Talk to people who use LPG at home. Find out what precautions they take in using LPG.
5. Make a model of a fire extinguisher. Place a short candle and a slightly taller candle in a small dish filled with baking soda. Place the dish at the bottom of a large bowl. Light both the candles. Then pour vinegar into the dish of baking soda. Take care. Do not pour vinegar on the candles. Observe the foaming reaction. What happens to the candles? Why? In what order?

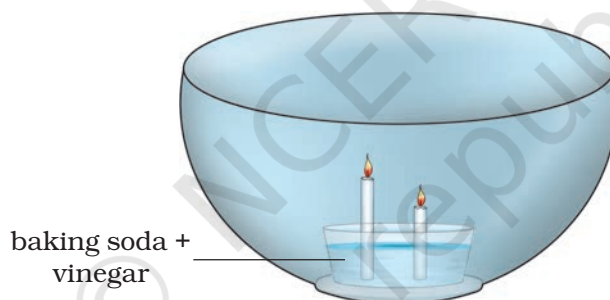

Fig. 6.15

For more information, visit:

- www.newton.dep.anl.gov/askasci/chem03/chem03767.htm
- <http://en.wikipedia.org/wiki/combustion>



We saw in Class VII that Paheli and Boojho had visited the forest along with Professor Ahmad and Tibu. They were eager to share their experiences with their classmates. Other children in the class were also eager to share their experiences as some of them had visited Bharatpur Sanctuary. Some others had heard about Kaziranga National Park, Lockchao Wildlife Sanctuary, Great Nicobar Biosphere Reserve and Tiger Reserve, etc.



What is the purpose of making national parks, wildlife sanctuaries and biosphere reserves?

7.1 Deforestation and Its Causes

A great variety of plants and animals exist on earth. They are essential for the well-being and survival of mankind. Today, a major threat to survival of these organisms is **deforestation**. We know that deforestation means clearing of forests and using that land for other purposes. Trees in the forest are cut for some of the purposes mentioned below:

- Procuring land for cultivation.
- Building houses and factories.
- Making furniture or using wood as fuel.

Some natural causes of deforestation are forest fires and severe droughts.

Activity 7.1

Add more causes of deforestation to your list and classify them into natural and man-made.

7.2 Consequences of Deforestation

Paheli and Boojho recalled the consequences of deforestation. They remembered that deforestation increases the temperature and pollution level on the earth. It increases the level of carbon dioxide in the atmosphere. Ground water level also gets lowered. They know that deforestation disturbs the balance in nature. They were told by Professor Ahmad that if cutting of trees continues, rainfall and the fertility of the soil will



How does deforestation reduce rainfall on the one hand and lead to floods on the other?

decrease. Moreover, there will be increased chances of natural calamities such as floods and droughts.

Recall that plants need carbon dioxide for photosynthesis. Fewer trees would mean that less carbon dioxide will be used up resulting in its increased

amount in the atmosphere. This will lead to global warming as carbon dioxide traps the heat rays reflected by the earth. The increase in temperature on the earth disturbs the water cycle and may reduce rainfall. This could cause **droughts**.

Deforestation is a major cause which leads to the change in soil properties. Physical properties of the soil get affected by plantation and vegetation. Recall from Class VII how trees prevent soil erosion. Fewer trees result in more soil erosion. Removal of the top layer of the soil exposes the lower, hard and rocky layers. This soil has less humus and is less fertile. Gradually the fertile land gets converted into deserts. It is called **desertification**.

Deforestation also leads to a decrease in the water holding capacity of the soil. The movement of water from the soil surface into the ground (infiltration rate) is reduced. So, there are floods. The other properties of the soil like nutrient content, texture etc., also change because of deforestation.

We have studied in Class VII that we get many products from forests. List these products. Will we face shortage of these products if we continue cutting trees?

Activity 7.2

Animal life is also affected by deforestation. How? List the points and discuss them in your class.

7.3 Conservation of Forest and Wildlife

Having become aware of the effects of deforestation, Paheli and Boojho are worried. They go to Professor Ahmad and ask him how forests and wildlife can be saved.

Biosphere is that part of the earth in which living organisms exist or which supports life. Biological diversity or biodiversity, refers to the variety of organisms existing on the earth, their interrelationships and their relationship with the environment.

Professor Ahmad organises a visit to a biosphere reserve for Paheli, Boojho and their classmates. He selects a place named Pachmarhi Biosphere Reserve. He knows that the plants and animals found here are similar to those of the upper Himalayan peaks and to those belonging to the lower western ghats. Professor Ahmad believes that the biodiversity found here is unique. He requests Madhavji, a forest employee, to guide the children inside the biosphere reserve. He explains that preserving areas of such biological importance make them a part of our national heritage.

Madhavji explains to the children that apart from our personal efforts and efforts of the society, government

To protect our flora and fauna and their habitats, **protected areas** called wildlife sanctuaries, national parks and biosphere reserves have been earmarked. Plantation, cultivation, grazing, felling trees, hunting and poaching are prohibited there.

Wildlife Sanctuary : Areas where animals are protected from any disturbance to them and their habitat.

National Park : Areas reserved for wild life where they can freely use the habitats and natural resources.

Biosphere Reserve : Large areas of protected land for conservation of wild life, plant and animal resources and traditional life of the tribals living in the area.

agencies also take care of the forests and animals. The government lays down rules, methods and policies to protect and conserve them. Wildlife sanctuaries, national parks, biosphere reserves etc., are protected areas for conservation of plants and animals present in that area.

7.4 Biosphere Reserve

Children along with Professor Ahmad and Madhavji enter the biosphere reserve area. Madhavji explains that **biosphere reserves** are the areas meant for conservation of biodiversity. As you are aware that biodiversity is the variety of plants, animals and microorganisms generally found in an area. The biosphere reserves help to maintain the biodiversity and culture of that area. A biosphere reserve may also contain other protected areas in it. The Pachmarhi Biosphere Reserve consists of one national park named Satpura and two wildlife sanctuaries named Bori and Pachmarhi (Fig. 7.1).

Activity 7.3

Find out the number of national parks, wildlife sanctuaries and biosphere reserves in your district, state and country. Record in Table 7.1. Show these areas in an outline map of your state and India.

Table 7.1 : Protected Areas for Conservation

Protected Areas —	National Park	Wildlife Sanctuary	Biosphere Reserve
In my district			
In my state			
In my country			



Fig. 7.1 : Pachmarhi Biosphere Reserve

Activity 7.4

List the factors disturbing the biodiversity of your area. Some of these factors and human activities may disturb the biodiversity unknowingly. List these human activities. How can these be checked? Discuss in your class and write a brief report in your notebook.

7.5 Flora and Fauna

As the children walk around the biosphere reserve they appreciate the

green wealth of the forest. They are very happy to see tall teak trees and animals inside the forest. Suddenly, Paheli finds a rabbit and wants to catch it. She starts running after it. Professor Ahmad stops her. He explains that animals are comfortable and happy in their own habitat. We should not disturb them. Madhavji explains that some animals and plants typically belong to a particular area. The plants and animals found in a particular area are termed **flora** and **fauna** respectively of that area.

Sal, teak, mango, *jamun*, silver ferns, *arjun*, etc., are the flora and *chinkara*, blue-bull, barking deer, *cheetal*, leopard, wild dog, wolf, etc. are examples of the fauna of the Pachmarhi Biosphere Reserve (Fig. 7.2).



(a)



(b)



(c)



(d)



(e)



(f)

Fig. 7.2 : (a) Wild dog (b) Cheetal (c) Wolf (d) Leopard (e) Fern (f) Jamun tree

Activity 7.5

Try to identify the flora and fauna of your area and list them.

7.6 Endemic Species

Soon the group quietly enters the deep forest. Children are surprised to see a very big squirrel. This squirrel has a big fluffy tail. They are very curious to know about it. Madhavji tells them that this is known as the giant squirrel and is endemic to this area.

Endemic species are those species of plants and animals which are found exclusively in a particular area. They are not naturally found anywhere else. A particular type of animal or plant may be endemic to a zone, a state or a country.

Madhavji shows *sal* and wild mango (Fig. 7.3 (a)) as two examples of the



Fig. 7.3 (a) : Wild Mango



I have heard that some of the endemic species may vanish. Is it true?

endemic flora of the Pachmarhi Biosphere Reserve. Bison, Indian giant squirrel [Fig. 7.3 (b)] and flying squirrel are endemic fauna of this area. Professor Ahmad explains that the destruction of their habitat, increasing population and introduction of new species may affect the natural habitat of endemic species and endanger their existence.



Fig. 7.3 (b) : Giant squirrel

Species is a group of population which are capable of interbreeding. This means that the members of a species can reproduce fertile offspring only with the members of their own species and not with members of other species. Members of a species have common characteristics.

Activity 7.6

Find out the endemic plants and animals of the region where you live.

7.7 Wildlife Sanctuary

Soon Paheli sees a board with 'Pachmarhi Wildlife Sanctuary' written on it.

Professor Ahmad explains that killing (poaching) or capturing animals in general is strictly prohibited and punishable by law in all such places. **Wildlife Sanctuaries** like reserve forests provide protection and suitable living conditions to wild animals. He also tells them that people living in wildlife sanctuaries are allowed to do certain activities such as grazing by their livestock, collecting medicinal plants, firewood, etc.

Some of the threatened wild animals like black buck, white eyed buck, elephant, golden cat, pink headed duck, *gharial*, marsh crocodile, python, rhinoceros, etc., are protected and preserved in our wild life sanctuaries. Indian sanctuaries have unique landscapes—broad level forests, mountain forests and bush lands in deltas of big rivers.

It is a pity that even protected forests are not safe because people living in the neighbourhood encroach upon them and destroy them.

Children are reminded of their visit to the zoo. They recall that zoos are also places where animals receive protection.



What is the difference between a zoo and a wildlife sanctuary?

Activity 7.7

Visit a nearby zoo. Observe the conditions provided to the animals. Were they suitable for the animals? Can animals live in artificial setting

instead of their natural habitat? In your opinion, will the animals be comfortable in a zoo or in their natural habitat?

7.8 National Park

On the roadside there was another board on which was written 'Satpura National Park'.

Children are now eager to go there. Madhavji tells them that these reserves are large and diverse enough to protect whole sets of ecosystems. They preserve flora, fauna, landscape and historic objects of an area. Satpura National Park is the first Reserve Forest of India. The finest Indian teak is found in this forest. There are more than one hundred National Parks in India.

Rock shelters are also found inside the Satpura National Park. These are evidences of prehistoric human life in these jungles. These give us an idea of the life of primitive people.

Rock paintings are found in these shelters. A total of 55 rock shelters have been identified in Pachmarhi Biosphere Reserve.

Figures of animals and men fighting, hunting, dancing and playing musical instruments are depicted in these paintings. Many tribals still live in the area.

As children move ahead, they see a board with 'Satpura Tiger Reserve' written on it. Madhavji explains that **Project Tiger** was launched by the government to protect the tigers in the country. The objective of this project was to ensure the survival and maintenance of the tiger population in the country.



Are tigers still found in this forest? I hope I can see a tiger!

Tiger (Fig. 7.4) is one of the many species which are slowly disappearing from our forests. But, the Satpura Tiger Reserve is unique in the sense that a significant increase in the population of tigers has been seen here. Once upon a time, animals like lions, elephants, wild



Fig. 7.4 : Tiger

buffaloes (Fig. 7.5) and barasingha (Fig. 7.6) were also found in the Satpura National Park. Animals whose numbers are diminishing to a level that they might face extinction are known as the **endangered animals**. Boojho is reminded of the dinosaurs which became extinct a long time ago. Survival of some



Fig. 7.5 : Wild buffalo



Fig. 7.6 : Barasingha

animals has become difficult because of disturbances in their natural habitat. Professor Ahmad tells them that in order to protect plants and animals strict rules are imposed in all National Parks. Human activities such as grazing, poaching, hunting, capturing of animals or collection of firewood, medicinal plants, etc. are not allowed



Are only big animals facing extinction?

Madhavji tells Paheli that small animals are much more in danger of becoming extinct than the bigger animals. At times, we kill snakes, frogs, lizards, bats and owls ruthlessly without realising their importance in the ecosystem. By killing them we are harming ourselves. They might be small in size but their role in the ecosystem cannot be ignored. They form part of food chains and food webs, about which you learnt in Class VII.

An **ecosystem** is made of all the plants, animals and microorganisms in an area along with non-living components such as climate, soil, river deltas etc.



I wonder if there is any record of all endangered species!

7.9 Red Data Book

Professor Ahmad explains about Red Data Book to the children. He tells them that **Red Data Book** is the source book which keeps a record of all the endangered animals and plants. Red Data Book is maintained internationally by an organisation. India also maintains Red Data Book for plants and animals found in India.

7.10 Migration

The excursion party then enters deeper into the forest under the guidance of Madhavji. They sit near the Tawa



What would happen if we had no wood? Is there any alternative available to wood? I know that paper is one of the important products we get from forests. I wonder whether there are any alternatives available for paper!

Reservoir to relax for some time. Paheli observes some of the birds near the river. Madhavji tells the children that these are migratory birds. These birds have flown here from other parts of the world.

Migratory birds fly to far away areas every year during a particular time because of climatic changes. They fly for laying eggs as the weather in their natural habitat becomes very cold and inhospitable. Birds who cover long distances to reach another land are known as migratory birds as Paheli learnt in Class VII.

7.11 Recycling of Paper

Professor Ahmad draws attention of the children to another cause of deforestation. He tells them that it takes 17 full grown trees to make one tonne of paper. Therefore, we should save paper. Professor Ahmad also tells that paper can be recycled five to seven times for use. If each student saves at least one sheet of paper in a day, we can save many trees in a year. We should save, reuse used paper and recycle it. By this we not only save trees but also save energy and water needed for manufacturing paper. Moreover, the amount of harmful chemicals used in paper making will also be reduced.



Is there any permanent solution to the problem of deforestation?

7.12 Reforestation

Professor Ahmad suggests that the answer to deforestation is reforestation. Reforestation is restocking of the destroyed forests by planting new trees. The planted trees should generally be of the same species which were found in that forest. We should plant at least as many trees as we cut. Reforestation can take place naturally also. If the deforested area is left undisturbed, it re-establishes itself. In natural reforestation there is no role of human beings. We have already caused tremendous damage to our forests. If we have to

retain our green wealth for future generations, plantation of more trees is the only option.

Professor Ahmad told them that in India we have the Forest (Conservation) Act. This act is aimed at preservation and conservation of natural forests and meeting the basic needs of the people living in or near the forests.

After some rest Madhavji asks the children to start heading back because it is not advisable to stay in the jungle after sunset. On getting back, Professor Ahmad and the children thank Madhavji for guiding them through this exciting experience.

KEYWORDS

BIODIVERSITY

BIOSPHERE RESERVE

DEFORESTATION

DESERTIFICATION

ECOSYSTEM

**ENDANGERED
SPECIES**

ENDEMIC SPECIES

EXTINCT

FAUNA

FLORA

MIGRATORY BIRDS

NATIONAL PARK

RED DATA BOOK

REFORESTATION

SANCTUARY

WHAT YOU HAVE LEARNT

- Wildlife sanctuary, national park and biosphere reserve are names given to the areas meant for conservation and preservation of forest and wild animals.
- Biodiversity refers to the variety of living organisms in a specific area.
- Plants and animals of a particular area are known as the flora and fauna of that area.
- Endemic species are found only in a particular area.
- Endangered species are those which are facing the danger of extinction.
- Red Data Book contains a record of endangered species.
- Migration is the phenomenon of movement of a species from its own habitat to some other habitat for a particular time period every year for a specific purpose like breeding.
- We should save, reuse and recycle paper to save trees, energy and water.
- Reforestation is the restocking of destroyed forests by planting new trees.

Exercises

1. Fill in the blanks.
 - (a) A place where animals are protected in their natural habitat is called _____.
 - (b) Species found only in a particular area is known as _____.
 - (c) Migratory birds fly to far away places because of _____ changes.
2. Differentiate between the following.
 - (a) Wildlife sanctuary and biosphere reserve
 - (b) Zoo and wildlife sanctuary
 - (c) Endangered and extinct species
 - (d) Flora and fauna

3. Discuss the effects of deforestation on the following.
 - (a) Wild animals
 - (b) Environment
 - (c) Villages (Rural areas)
 - (d) Cities (Urban areas)
 - (e) Earth
 - (f) The next generation
4. What will happen if.
 - (a) we go on cutting trees.
 - (b) the habitat of an animal is disturbed.
 - (c) the top layer of soil is exposed.
5. Answer in brief.
 - (a) Why should we conserve biodiversity?
 - (b) Protected forests are also not completely safe for wild animals. Why?
 - (c) Some tribals depend on the jungle. How?
 - (d) What are the causes and consequences of deforestation?
 - (e) What is Red Data Book?
 - (f) What do you understand by the term migration?
6. In order to meet the ever-increasing demand in factories and for shelter, trees are being continually cut. Is it justified to cut trees for such projects? Discuss and prepare a brief report.
7. How can you contribute to the maintenance of green wealth of your locality? Make a list of actions to be taken by you.
8. Explain how deforestation leads to reduced rainfall.
9. Find out about national parks in your state. Identify and show their location on the outline map of India.
10. Why should paper be saved? Prepare a list of ways by which you can save paper.

3. Is it justified to prevent tribals from staying in the core area of the forest? Discuss the matter in your class and note down the points for and against the motion in your notebook.
4. Study the biodiversity of a park nearby. Prepare a detailed report with photographs and sketches of the flora and fauna.
5. Make a list of the new information you have gathered from this chapter. Which information did you find the most interesting and why?
6. Make a list of various uses of papers. Observe currency notes carefully. Do you find any difference between a currency paper and paper of your notebook? Find out where currency paper is made.
7. Karnataka Government had launched 'Project Elephant' to save Asian elephants in the state. Find out about this and other such campaigns launched to protect threatened species.

Did You Know?

1. India has more than half of the world's wild tigers, 65% of the Asian elephants, 85% of the great one-horned rhinoceros and 100% of the Asian lions.
2. India is sixth on a list of 12 mega-biodiversity countries in the world. It contains two of the 34 biodiversity hotspots of the world – Eastern Himalayas and the Western Ghats. These areas are very rich in biodiversity.
3. One of the most important factors that threatens wildlife today is habitat destruction due to encroachment.
4. India contains 172 species of animals considered globally threatened or 2.9% of the world's total number of threatened species. Eastern Himalayas hotspot has merely 163 globally threatened species including several animal and plant species. India contains globally important population of some of Asia's rarest animals such as the *Bengal fox*, *Marbled cat*, Asiatic lion, Indian elephant, Asiatic wild ass, Indian rhinoceros, *gaur*, Wild asiatic water buffalo, etc.

For knowing more, you may contact:

- Ministry of Environment, Forest and Climate Change, Govt. of India
Environment, Forest and Wildlife Department
Indira Paryavaran Bhavan, Jor Bagh Road, New Delhi -110003
Website: <http://envfor.nic.in>



You have already learnt that things around us are either living or non-living. Further, you may recall that all living organisms carry out certain basic functions. Can you list these functions?

Different sets of organs perform the various functions you have listed. In this chapter, you shall learn about the basic structural unit of an organ, which is the **cell**. Cells may be compared to bricks. Bricks are assembled to make a building. Similarly, cells are assembled to make the body of every organism.

8.1 Discovery of the Cell

Robert Hooke in 1665 observed slices of cork under a simple magnifying device. Cork is a part of the bark of a tree. He took thin slices of cork and observed them under a microscope. He noticed partitioned boxes or compartments in the cork slice (Fig. 8.1).

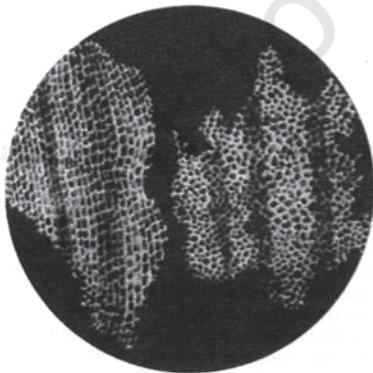

Fig. 8.1: Cork cells as observed by Robert Hooke

These boxes appeared like a honeycomb. He also noticed that one box was separated from the other by a wall or partition. Hooke coined the term 'cell' for each box. What Hooke observed as boxes or cells in the cork were actually dead cells.

Cells of living organisms could be observed only after the discovery of improved microscopes. Very little was known about the cell for the next 150 years after Robert Hooke's observations. Today, we know a lot about cell structure and its functions because of improved microscopes having high magnification.

8.2 The Cell

Both, bricks in a building and cells in the living organisms, are **basic structural units** [Fig. 8.2(a), (b)]. The buildings, though built of similar bricks, have different designs, shapes and sizes. Similarly, in the living world, organisms differ from one another but all are made up of cells. Cells in the living organisms are complex living structures unlike non-living bricks.



A hen's egg can be seen easily. Is it a cell or a group of cells?



(a) Brick wall

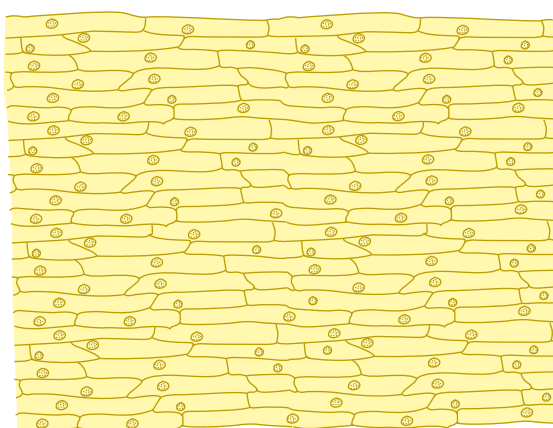

(b) Onion peel

Fig. 8.2 : Brick wall and onion peel

The egg of a hen represents a single cell and is big enough to be seen by the unaided eye.

8.3 Organisms show Variety in Cell Number, Shape and Size

How do scientists observe and study the living cells? They use microscopes which magnify objects. Stains (dyes) are used to colour parts of the cell to study the detailed structure.

There are millions of living organisms. They are of different shapes and sizes. Their organs also vary in shape, size and number of cells. Let us study about some of them.

Number of Cells

Can you guess the number of cells in a tall tree or in a huge animal like the elephant? The number runs into billions and trillions. Human body has trillions of cells which vary in shapes and sizes. Different groups of cells perform a variety of functions.

A billion is a thousand million. A trillion is a thousand billion.

Organisms made of more than one cell are called **multicellular** (*multi* : many; *cellular* : cell) organisms. The number of cells being less in smaller organisms does not, in any way, affect the functioning of the organisms. You will be surprised to know that an organism with billions of cells begins life as a **single cell** which is the fertilised egg. The fertilised egg cell multiplies and the number of cells increase as development proceeds.

Look at Fig 8.3 (a) and (b). Both organisms are made up of a single cell. The single-celled organisms are called **unicellular** (*uni* : one; *cellular* : cell)

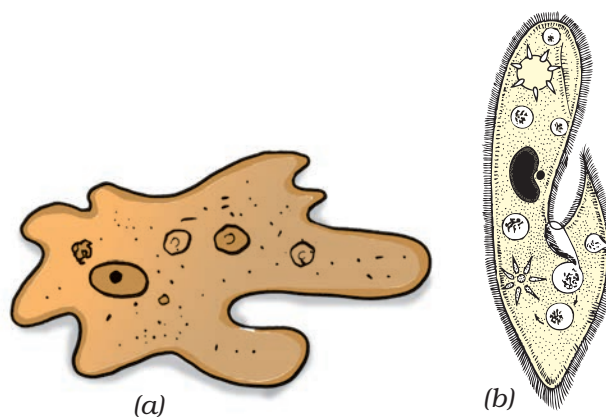

Fig. 8.3 : (a) Amoeba (b) Paramecium

organisms. A single-celled organism performs all the necessary functions that multicellular organisms perform.

A single-celled organism, like *amoeba*, captures and digests food, respire, excrete, grows and reproduces. Similar functions in multicellular organisms are carried out by groups of specialised cells forming different tissues. Tissues, in turn, form organs.

Activity 8.1

The teacher may show a permanent slide of *amoeba* and *paramecium* under a microscope. Alternatively, the teacher can collect pond water and show these organisms by preparing the slides.

Shape of Cells

Refer to Fig. 8.3 (a). How do you define the shape of *amoeba* in the figure? You may say that the shape appears irregular. Infact, *amoeba* has no definite shape, unlike other organisms. It keeps on changing its shape. Observe the projections of varying lengths protruding out of its body. These are called **pseudopodia** (*pseudo* : false; *podia* : feet), as you learnt in Class VII. These projections appear and disappear as *amoeba* moves or feeds.



What advantage does *amoeba* derive by changing shape?

The change in shape is due to formation of pseudopodia which facilitates movement and help in capturing food.



A white blood cell (WBC) in human blood is another example of a single cell which can change its shape. But while WBC is a cell, *amoeba* is a full fledged organism capable of independent existence.

What shape would you expect in organisms with millions of cells? Fig. 8.4 (a, b, c) shows different cells such as blood, muscle and nerve of human beings. The different shapes are related to their specific functions.

Generally, cells are round, spherical or elongated [Fig. 8.4(a)]. Some cells are long and pointed at both ends. They exhibit a spindle shape [Fig. 8.4(b)]. Cells sometimes are quite long. Some are branched like the nerve cell or a neuron [Fig. 8.4(c)]. The nerve cell receives and transfers messages, thereby

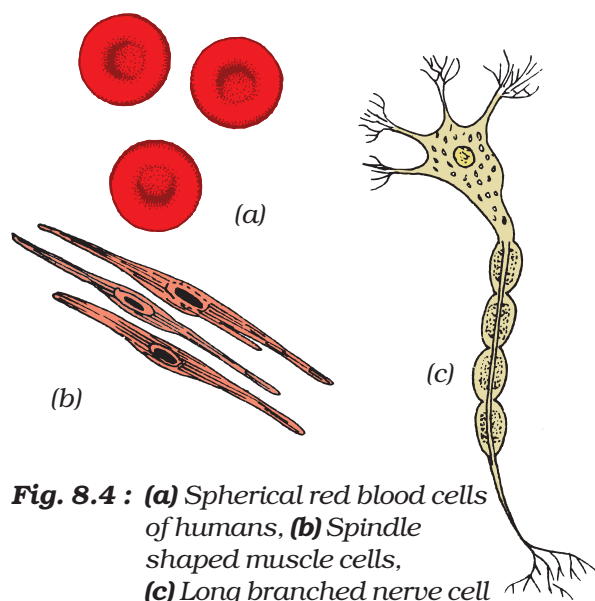

Fig. 8.4 : (a) Spherical red blood cells of humans, (b) Spindle shaped muscle cells, (c) Long branched nerve cell

helping to control and coordinate the working of different parts of the body.

Can you guess, which part of the cell gives it shape? Components of the cell are enclosed in a membrane. This membrane provides shape to the cells of plants and animals. Cell wall is an additional covering over the cell membrane in plant cells. It gives shape and rigidity to these cells (Fig. 8.7). Bacterial cell also has a cell wall.

Size of Cells

The size of cells in living organisms may be as small as a millionth of a metre (micrometre or micron) or may be as large as a few centimetres. However, most of the cells are microscopic in size and are not visible to the unaided eye. They need to be enlarged or magnified by a microscope. The smallest cell is 0.1 to 0.5 micrometre in bacteria. The largest cell measuring 170 mm × 130 mm, is the egg of an ostrich.

Activity 8.2

Boil a hen's egg. Remove the shell. What do you observe? A white material surrounds the yellow part. White material is albumin which solidifies on boiling. The yellow part is yolk. It is part of the single cell. You can observe this single cell without any magnifying device.



Are the cells in an elephant larger than the cells in a rat?

The size of the cells has no relation with the size of the body of the animal or plant. It is not necessary that the cells in

the elephant be much bigger than those in a rat. The size of the cell is related to its function. For example, nerve cells, both in the elephant and rat, are long and branched. They perform the same function, that of transferring messages.

8.4 Cell Structure and Function

You have learnt that each living organism has many organs. You have studied in Class VII about the digestive organs which together constitute the digestive system. Each organ in the system performs different functions such as digestion, assimilation and absorption. Similarly, different organs of a plant perform specific/specialised functions. For example, roots help in the absorption of water and minerals. Leaves, as you have learnt in Class VII, are responsible for synthesis of food.

Each organ is further made up of smaller parts called **tissues**. A tissue is a group of similar cells performing a specific function.

Paheli realised that an organ is made up of tissues which in turn, are made up of cells. The cell in a living organism is the basic structural unit.

8.5 Parts of the Cell

Cell Membrane

The basic components of a cell are cell membrane, cytoplasm and nucleus (Fig. 8.7). The cytoplasm and nucleus are enclosed within the cell membrane, also called the plasma membrane. The membrane separates cells from one another and also the cell from the surrounding medium. The plasma membrane is porous and allows the

movement of substances or materials both inward and outward.

Activity 8.3

In order to observe the basic components of the cell, take an onion bulb. Remove the dry pink coverings (peels). You can easily separate these from the fleshy white layers of the bulb with the help of forceps or even with your hand. You can also break the onion bulb and separate out thin layers. Place a small piece of the thin onion peel in a drop of water on a glass slide. The thin layer can be cut into smaller pieces with the help of a blade or forceps. Add a drop of methylene blue solution to the layer and place a coverslip on it. While placing the coverslip ensure that there are no air bubbles under the coverslip. Observe the slide under the microscope. Draw and label. You may compare it with Fig. 8.5.

The boundary of the onion cell is the **cell membrane** covered by another thick covering called the cell wall. The central dense round body in the centre is called the **nucleus**. The jelly-like substance

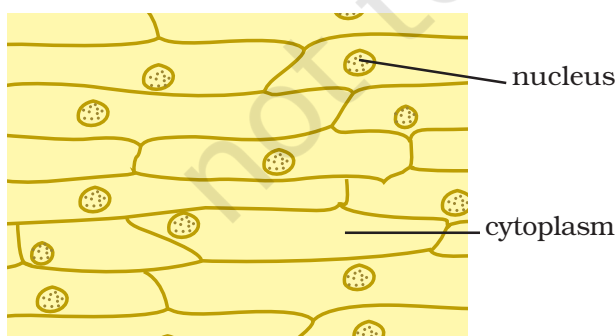

Fig. 8.5 : Cells observed in an onion peel

between the nucleus and the cell membrane is called **cytoplasm**.

I want to know why plant cells need cell walls?



You have learnt earlier that the cell membrane gives shape to the cell. In addition to the cell membrane, there is an outer thick layer in cells of plants called **cell wall**. This additional layer surrounding the cell membrane is required by plants for protection. Plant cells need protection against variations in temperature, high wind speed, atmospheric moisture etc. They are exposed to these variations because they cannot move. Cells can be observed in the leaf peel of *Tradescantia*, *Elodea* or *Rhoeo*. You can prepare a slide as in the case of onion.

Paheli asks Boojho if he can also observe animal cells.

Activity 8.4

Take a clean tooth pick, or a matchstick with the tip broken. Scrape inside of your cheek without hurting it. Place it in a drop of water on a glass slide. Add a drop of iodine and place a coverslip over it. Alternatively, add 1-2 drops of methylene blue solution. Observe it under the microscope. You may notice several cells in the scraped material (Fig. 8.6). You can identify the cell membrane, the cytoplasm and nucleus. A cell wall is absent in animal cells.

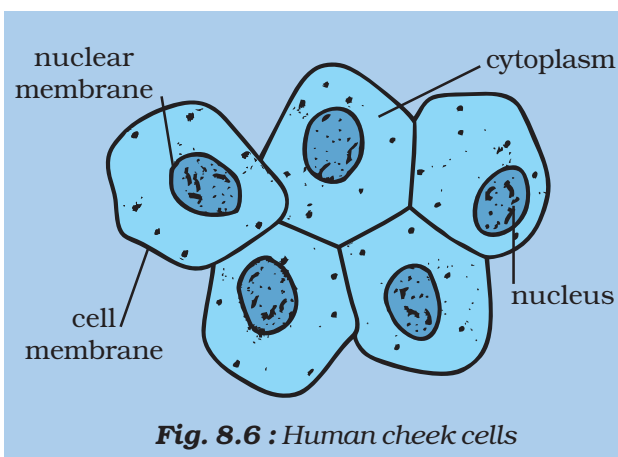

Fig. 8.6 : Human cheek cells

Cytoplasm

It is the jelly-like substance present between the cell membrane and the nucleus. Various other components, or **organelles**, of cells are present in the cytoplasm. These are mitochondria, golgi bodies, ribosomes, etc. You will learn about them in later classes.

Nucleus

It is an important component of the living cell. It is generally spherical and located in the centre of the cell. It can be stained and seen easily with the help of a microscope. Nucleus is separated from the cytoplasm by a membrane called the **nuclear membrane**. This membrane is also porous and allows the movement of materials between the cytoplasm and the inside of the nucleus.

With a microscope of higher magnification, we can see a smaller spherical body in the nucleus. It is called the **nucleolus**. In addition, nucleus contains thread-like structures called **chromosomes**. These carry **genes** and help in inheritance or transfer of characters from the parents to the offspring. The chromosomes can be seen only when the cell divides.

Gene

Gene is a unit of inheritance in living organisms. It controls the transfer of a hereditary characteristic from parents to offspring. This means that your parents pass some of their characteristics on to you. If your father has brown eyes, you may also have brown eyes. If your mother has curly hair, you might also end up having curly hair. However, the different combination of genes from parents result in different characteristics.

Nucleus, in addition to its role in inheritance, acts as control centre of the activities of the cell. The entire content of a living cell is known as protoplasm. It includes the cytoplasm and the nucleus. Protoplasm is called the living substance of the cell.



Paheli wants to know if the structure of the nucleus is the same in cells of plants, animals and bacteria.

The nucleus of the bacterial cell is not well-organised like the cells of multicellular organisms. There is no nuclear membrane. The cells having nuclear material without nuclear membrane are termed **prokaryotic cells**. The organisms with these kinds of cells are called **prokaryotes** (*pro* : primitive; *karyon* : nucleus). Examples are bacteria and blue green algae. The cells, like onion cells and cheek cells having well-organised nucleus with a nuclear membrane are designated as **eukaryotic cells**. All organisms other than bacteria and blue green algae are called **eukaryotes**. (*eu* : true; *karyon*: nucleus).

While observing the onion cells under the microscope, did you notice any blank-looking structures in the cytoplasm? It is called **vacuole**. It could be single and big as in an onion cell. Cheek cells have smaller vacuoles. Large vacuoles are common in plant cells. Vacuoles in animal cells are much smaller.

You might have noticed several small coloured bodies in the cytoplasm of the cells of *Tradescantia* leaf. They are scattered in the cytoplasm of the leaf cells. These are called **plastids**. They are of different colours. Some of them contain green pigment called chlorophyll. Green coloured plastids are

called **chloroplasts**. They provide green colour to the leaves. You may recall that chlorophyll in the chloroplasts of leaves, is essential for photosynthesis.

8.6 Comparison of Plant and Animal Cells

If you recall Activities 8.3 and 8.4, you should be able to compare plant and animal cells. Observe the plant and animal cell carefully in Fig. 8.7 (a), (b).

Let us tabulate the similarities and distinguishing features of plant and animal cells. Only a few features are mentioned. You may add more in Table 8.1.

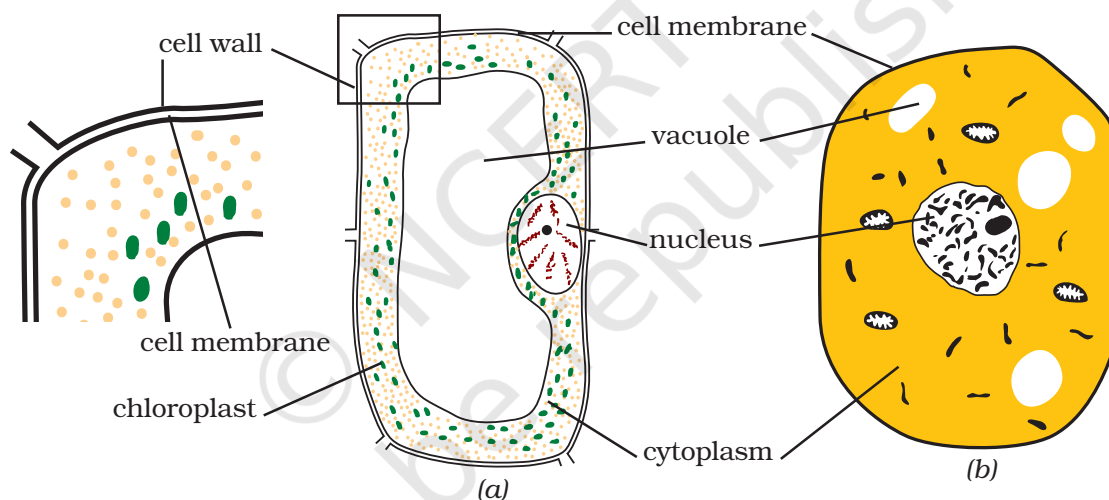

Fig. 8.7 : (a) Plant cell (b) Animal cell

Table 8.1 : Comparison of Plant Cell and Animal Cell

Sl. No.	Part	Plant Cell	Animal Cell
1.	Cell membrane	Present	Present
2.	Cell wall	Present	Absent
3.	Nucleus		
4.	Nuclear membrane		
5.	Cytoplasm		
6.	Plastids		
7.	Vacuole		

KEYWORDS

CELL

CELL MEMBRANE

CELL WALL

CHLOROPLAST

CHROMOSOME

CYTOPLASM

EUKARYOTES

GENE

MULTICELLULAR

NUCLEAR MEMBRANE

NUCLEOLUS

NUCLEUS

ORGAN

ORGANELLES

PLASMA MEMBRANE

PLASTID

PROKARYOTES

PSEUDOPODIA

TISSUE

UNICELLULAR

VACUOLE

WHITE BLOOD CELL
(WBC)

WHAT YOU HAVE LEARNT

- All organisms are made of smaller parts called organs.
- Organs are made of still smaller parts. The smallest living part of an organism is a 'cell'.
- Cells were first observed in cork by Robert Hooke in 1665.
- Cells exhibit a variety of shapes and sizes.
- Number of cells also varies from organism to organism.
- Some cells are big enough to be seen with the unaided eye. Hen's egg is an example.
- Some organisms are single-celled, while others contain large number of cells.
- The single cell of unicellular organisms performs all the basic functions performed by a variety of cells in multicellular organisms.
- The cell has three main parts: (i) the cell membrane, (ii) cytoplasm which contains smaller components called organelles, and (iii) the nucleus.
- Nucleus is separated from cytoplasm by a nuclear membrane.
- Cells without well-organised nucleus, i.e. lacking nuclear membrane, are called prokaryotic cells.
- Plant cells differ from animal cells in having an additional layer around the cell membrane termed cell wall.
- Coloured bodies called plastids are found in the plant cells only. Green plastids containing chlorophyll are called chloroplasts.
- Plant cell has a big central vacuole unlike a number of small vacuoles in animal cells.

Exercises

- Indicate whether the following statements are True (T) or False (F).
 - Unicellular organisms have one-celled body. (T/F)
 - Muscle cells are branched. (T/F)
 - The basic living unit of an organism is an organ. (T/F)
 - Amoeba* has irregular shape. (T/F)
- Make a sketch of the human nerve cell. What function do nerve cells perform?.
- Write short notes on the following.
 - Cytoplasm
 - Nucleus of a cell
- Which part of the cell contains organelles?
- Make sketches of animal and plant cells. State three differences between them.
- State the difference between eukaryotes and prokaryotes.
- Where are chromosomes found in a cell? State their function.
- 'Cells are the basic structural units of living organisms'. Explain.
- Explain why chloroplasts are found only in plant cells?
- Complete the crossword with the help of clues given below.

Across

- This is necessary for photosynthesis.
- Term for component present in the cytoplasm.
- The living substance in the cell.
- Units of inheritance present on the chromosomes.

Down

- Green plastids.
- Formed by collection of tissues.
- It separates the contents of the cell from the surrounding medium.
- Empty structure in the cytoplasm.
- A group of cells.

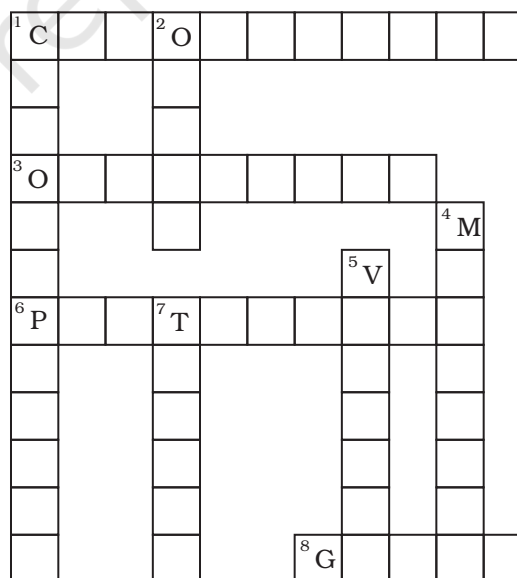

Extended Learning — Activities and Projects

1. Visit a laboratory for senior secondary students in your school or in a neighbouring school. Learn about the functioning of a microscope in the laboratory. Also observe how a slide is observed under the microscope.
2. Talk to the senior biology teacher in your school or a neighbouring school. Find out if there are diseases which are passed on from parents to the offspring. Find out how these are carried and also if these diseases can be treated. For this you can also visit a doctor.
3. Visit an agriculture extension centre in your area. Find out about genetically modified (GM) crops. Prepare a short speech for your class on this topic.
4. Find out about *Bt* cotton from an agriculture expert. Prepare a short note on its advantages/disadvantages.

Did You Know?

The cells in the outermost layer of our skin are dead. An average adult carries around about 2 kg of dead skin. Billions of tiny fragments of the skin are lost every day. Every time you run your finger on a dusty table, you shed a lot of old skin.



Do you recall the processes of digestion, circulation and respiration which you have studied in your previous classes? These processes are essential for the survival of every individual. You have also learnt about the process of reproduction in plants. Reproduction is essential for the continuation of a species. Imagine what would have happened if organisms had not reproduced. You will realise that reproduction is very important as it ensures the continuation of similar kinds of individuals, generation after generation.

You have already learnt in your previous class about reproduction in plants. In this chapter, we shall learn how reproduction takes place in animals.

9.1 Modes of Reproduction

Have you seen the young ones of different animals? Try to name some of the young ones by completing Table 9.1 shown in examples at S. No. 1 and 5.

You must have seen the young ones of various animals being born. Can you tell how chicks and caterpillars are born? How are kittens and puppies born? Do you think that these young ones looked the same before they were born as they do now? Let us find out.

Table 9.1

S. No.	Animal	Young one
1.	Human	Baby
2.	Cat	
3.	Dog	
4.	Butterfly	
5.	Hen	Chick
6.	Cow	
7.	Frog	

Just as in plants, there are two modes by which animals reproduce. These are:
 (i) Sexual reproduction, and
 (ii) Asexual reproduction.

9.2 Sexual Reproduction

Try to recall reproduction in plants which you studied in Class VII. You will remember that plants that reproduce sexually have male and female reproductive parts. Can you name these parts? In animals also, males and females have different reproductive parts or organs. Like plants, the reproductive parts in animals also produce gametes that fuse to form a zygote. It is the zygote which develops into a new individual. This type of reproduction beginning from the fusion of male and female gametes is called **sexual reproduction**. Let us find out the reproductive parts

in humans and study the process of reproduction in them.

Male Reproductive Organs

The male reproductive organs include a pair of testes (singular, testis), two sperm ducts and a penis (Fig. 9.1). The testes produce the male gametes called **sperms**. Millions of sperms are produced by the testes. Look at Fig. 9.2 which shows the picture of a sperm. Though sperms are very small in size, each has a head, a middle piece and a tail. Does it appear to be a single cell? Indeed, each

sperm is a single cell with all the usual cell components.

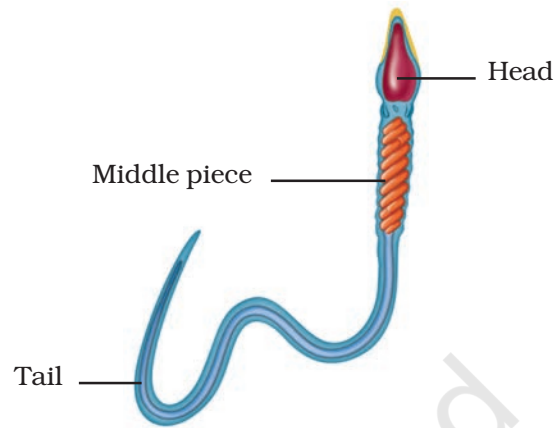

Fig. 9.2 : Human sperm

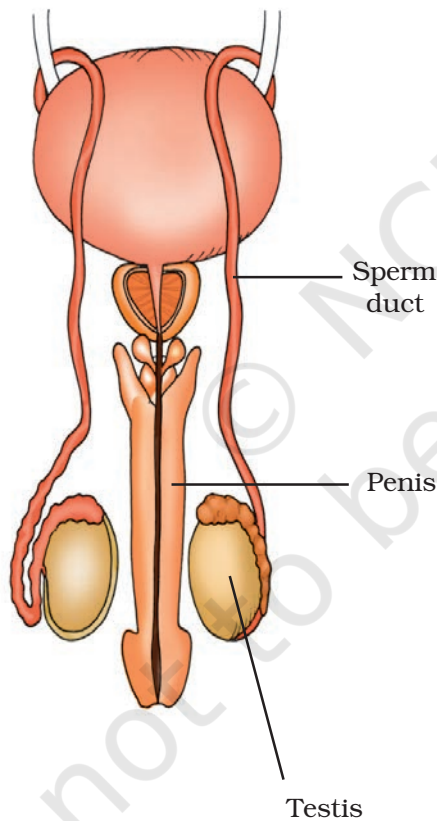

Fig. 9.1: Male reproductive organs in humans



What purpose does the tail in a sperm serve?

Female Reproductive Organs

The female reproductive organs are a pair of ovaries, oviducts (fallopian tubes) and the uterus (Fig. 9.3). The ovary produces

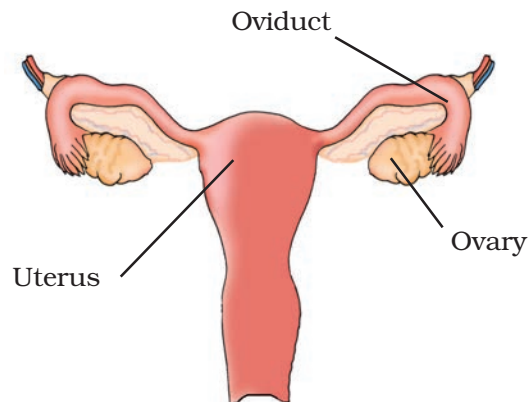

Fig. 9.3 : Female reproductive organs in humans

female gametes called **ova (eggs)** (Fig. 9.4). In human beings, a single matured egg is released into the oviduct by one of the ovaries every month. Uterus is the part where development of the baby takes place. Like the sperm, an egg is also a single cell.

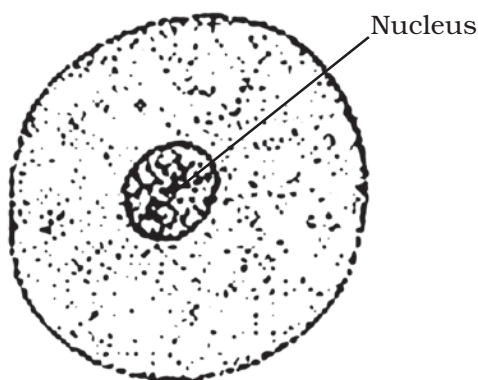

Fig. 9.4 : Human Ovum

Boojho recalls that the size of eggs in animals varies. The egg may be very small as in humans, much larger as in hens. Ostrich egg is the largest!



Fertilisation

The first step in the process of reproduction is the fusion of a sperm and an ovum. When sperms come in contact with an egg, one of the sperms may fuse with the egg. Such fusion of the egg and the sperm is called **fertilisation** (Fig. 9.5). During fertilisation, the nuclei of the sperm and the egg fuse to form a single nucleus. This results in the formation of a fertilised egg or **zygote** (Fig. 9.6). Did

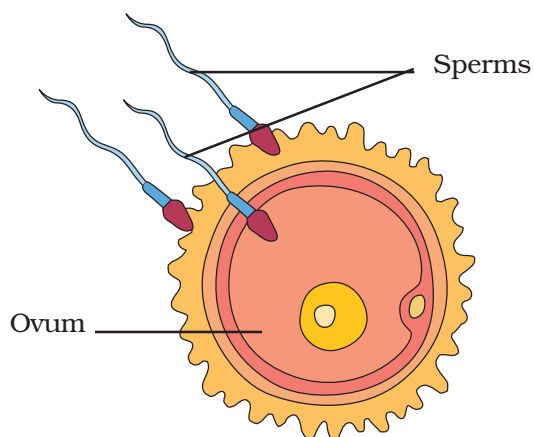

Fig. 9.5 : Fertilisation

you know that the zygote is the beginning of a new individual?

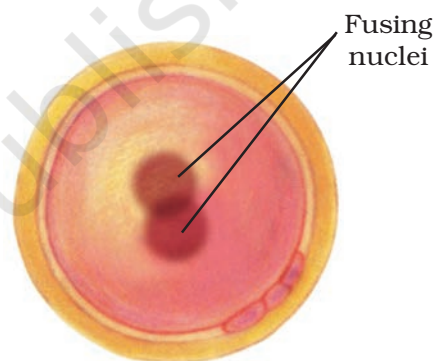

Fig. 9.6 : Zygote

The process of fertilisation is the meeting of an egg cell from the mother and a sperm cell from the father. So, the new individual inherits some characteristics from the mother and some from the father. Look at your brother or sister. See if you can recognise some characters in them similar to those of your mother or your father.

Fertilisation which takes place inside the female body is called **internal fertilisation**. Internal fertilisation occurs in many animals including humans, cows, dogs and hens.

Have you heard of test tube babies?

Boojho and Paheli's teacher once told them in the class that in some women oviducts are blocked. These women are unable to bear babies because sperms cannot reach the egg for fertilisation. In such cases, doctors collect freshly released egg and sperms and keep them together for a few hours for **IVF** or **in vitro fertilisation** (fertilisation outside the body). In case fertilisation occurs, the zygote is allowed to develop for about a week and then it is placed in the mother's uterus. Complete development takes place in the uterus and the baby is born like any other baby. Babies born through this technique are called **test-tube babies**. This term is actually misleading because babies cannot grow in test tubes.

You will be surprised to know that in many animals fertilisation takes place outside the body of the female. In these animals, fertilisation takes place in water. Let us find out how this happens.

Activity 9.1

Visit some ponds or slow-flowing streams during spring or rainy season. Look out for clusters of frog's eggs floating in water. Write down the colour and size of the eggs.

During spring or rainy season, frogs and toads move to ponds and slow-flowing streams. When the male and female come together in water, the

female lays hundreds of eggs. Unlike hen's egg, frog's egg is not covered by a shell and it is comparatively very delicate. A layer of jelly holds the eggs together and provides protection to the eggs (Fig. 9.7).



Fig. 9.7 : Eggs of frog

As the eggs are laid, the male deposits sperms over them. Each sperm swims randomly in water with the help of its long tail. The sperms come in contact with the eggs. This results in fertilisation. This type of fertilisation in which the fusion of a male and a female gamete takes place outside the body of the female is called **external fertilisation**. It is very common in aquatic animals such as fish, starfish, etc.



Why do fish and frogs lay eggs in hundreds whereas a hen lays only one egg at a time?



Though these animals lay hundreds of eggs and release millions of sperms, all the eggs do not get fertilised and develop into new individuals.

This is because the eggs and sperms get exposed to water movement, wind and rainfall. Also, there are other animals in the pond which may feed on eggs. Thus, production of large number of eggs and sperms is necessary to ensure fertilisation of at least a few of them.



How could a single cell become such a big individual?

Development of Embryo

Fertilisation results in the formation of zygote which begins to develop into an embryo [Fig. 9.8(a)]. The zygote divides repeatedly to give rise to a ball of cells [Fig. 9.8(b)]. The cells then begin to form groups that develop into different tissues and organs of the body. This developing structure is termed an **embryo**. The embryo gets embedded in the wall of the uterus for further development [Fig. 9.8(c)].

The embryo continues to develop in the uterus. It gradually develops body

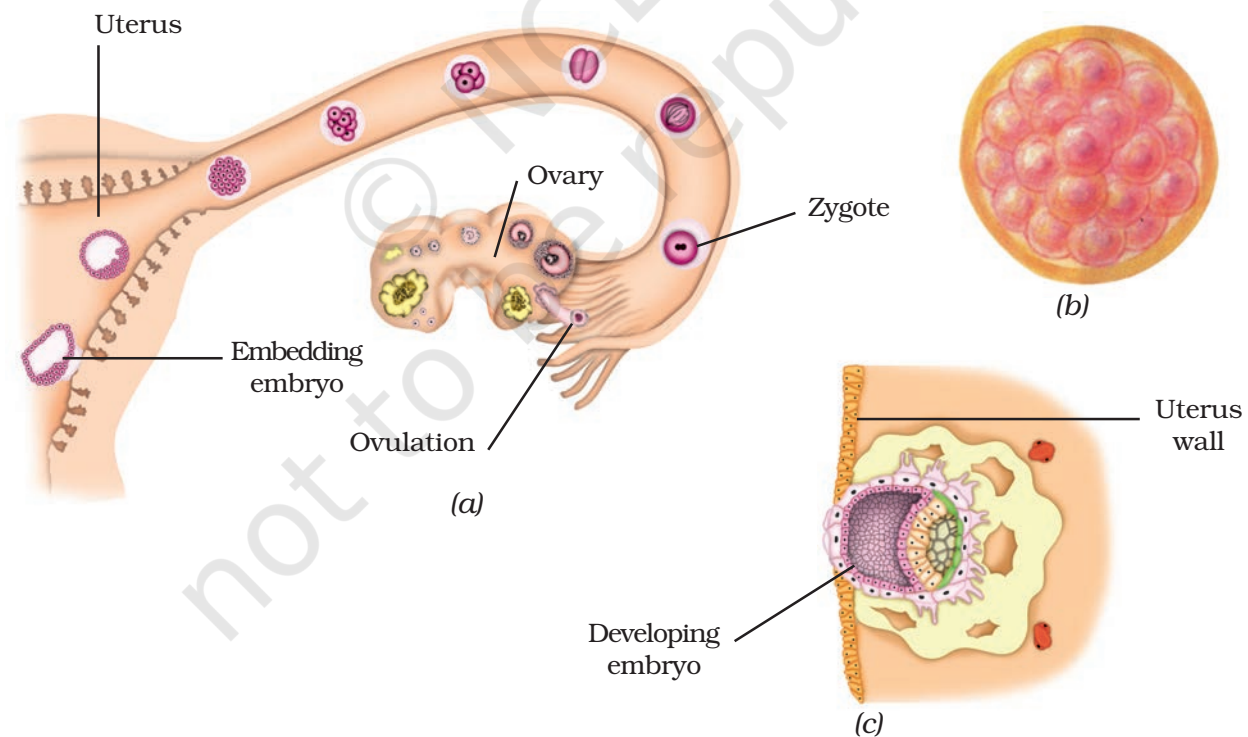

Fig. 9.8 : (a) Zygote formation and development of an embryo from the zygote; (b) Ball of cells (enlarged); (c) Embedding of the embryo in the uterus (enlarged)

parts such as hands, legs, head, eyes, ears etc. The stage of the embryo in which all the body parts can be identified is called a **foetus** (Fig. 9.9). When the development of the foetus is complete, the mother gives birth to the baby.

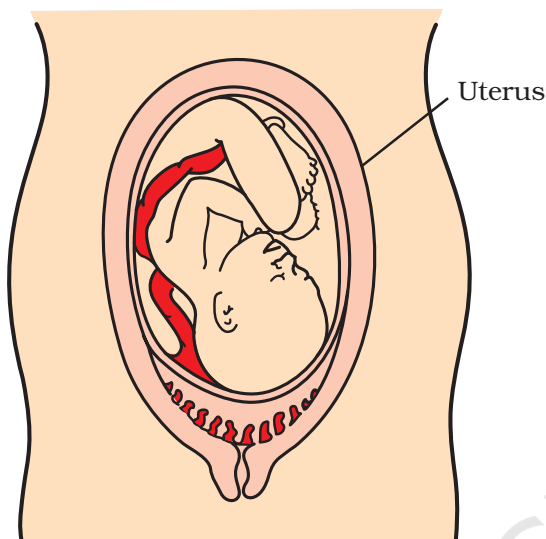

Fig. 9.9 : Foetus in the uterus

Internal fertilisation takes place in hens also. But, do hens give birth to babies like human beings and cows? You know that they do not. Then, how are chicks born? Let us find out.

Soon after fertilisation, the zygote divides repeatedly and travels down the oviduct. As it travels down, many protective layers are formed around it. The hard shell that you see in a hen's egg is one such protective layer.

After the hard shell is formed around the developing embryo, the hen finally lays the egg. The embryo takes about 3 weeks to develop into a chick. You must have seen the hen sitting on the eggs to provide sufficient warmth. Did you know that development of the chick takes

place inside the egg shell during this period? After the chick is completely developed it bursts open the egg shell.

In animals which undergo external fertilisation, development of the embryo takes place outside the female body. The embryos continue to grow within their egg coverings. After the embryos develop, the eggs hatch. You must have seen numerous tadpoles swimming in ponds and streams.

Viviparous and Oviparous Animals

We have learnt that some animals give birth to young ones while some animals lay eggs which later develop into young ones. The animals which give birth to young ones are called **viviparous** animals. Those animals which lay eggs are called **oviparous** animals. The following activity will help you understand better and differentiate between viviparous and oviparous animals.

Activity 9.2

Try to observe eggs of the following organisms – frog, lizard, butterfly or moth, hen and crow or any other bird. Were you able to observe eggs of all of them? Make drawings of the eggs that you have observed.

The eggs of a few animals are easy to observe because their mothers lay them outside their bodies. These are examples of oviparous animals. But you would not be able to collect the eggs of a dog, cow or cat. This is because they do not lay eggs. The mother gives birth to the young ones. These are examples of viviparous animals.

Can you now give some more examples of viviparous and oviparous animals?

Young Ones to Adults

The new individuals which are born or hatched from the eggs continue to grow till they become adults. In some animals, the young ones may look very different from the adults. Recall the life cycle of the silkworm (egg → larva or caterpillar → pupa → adult) you studied in Class VII. Frog is another such example (Fig. 9.10).

Observe the different stages of frog starting from the egg to the adult stage. We find that there are three distinct stages, that is, egg → tadpole (larva) → adult. Don't the tadpoles look so different from the adults? Can you imagine that these tadpoles would some day become frogs? Similarly, the caterpillar or the pupa of silkworm looks very different from the adult moth. The

features that are present in the adult are not found in these young ones. Then what happens to the tadpoles or caterpillars thereafter?

You must have seen a beautiful moth emerging out of the cocoon. In the case of tadpoles, they transform into adults capable of jumping and swimming. The transformation of the larva into an adult through drastic changes is called **metamorphosis**. What about the changes that we observe in our body as we grow? Do you think we too undergo metamorphosis? In human beings, body parts similar to those present in the adults are present from the time of birth.

9.3 Asexual Reproduction

So far, we have learnt about reproduction in some familiar animals. But what about very small animals like hydra and microscopic organisms like amoeba? Do you know how they reproduce? Let us find out.

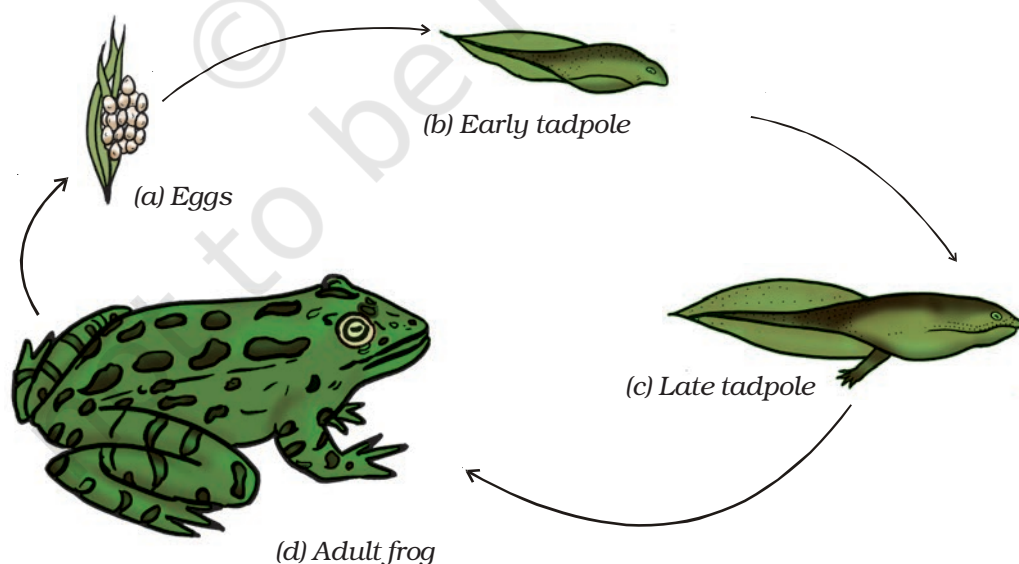

Fig. 9.10 : Life cycle of frog

Activity 9.3

Get permanent slides of hydra. Observe them using hand lens or a microscope. Look out for any bulges from the parent body. Count the number of bulges that you see in different slides. Also, note the size of the bulges. Draw the diagram of hydra, as you see it. Compare it with the Fig. 9.11.

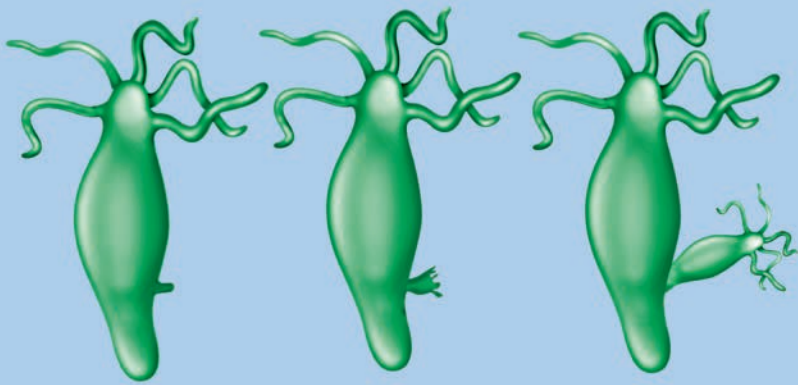

Fig. 9.11 : Budding in Hydra

In each hydra, there may be one or more bulges. These bulges are the developing new individuals and they are called **buds**. Recall the presence of buds in yeast. In hydra too the new individuals develop as outgrowths from a single parent. This type of reproduction in which only a single parent is involved is called **asexual reproduction**. Since new individuals develop from the buds in hydra, this type of asexual reproduction is called **budding**.

Another method of asexual reproduction is observed in the microscopic organism, amoeba. Let us see how this happens.

You have already learnt about the structure of amoeba. You will recall that amoeba is a single-celled organism [Fig. 9.12(a)]. It begins the process of reproduction by the division of its nucleus into two nuclei [Fig. 9.12(b)]. This is followed by division of its body into two, each part receiving a nucleus [Fig. 9.12(c)]. Finally, two amoebae are produced from one parent amoeba [Fig. 9.12(d)]. This type of asexual

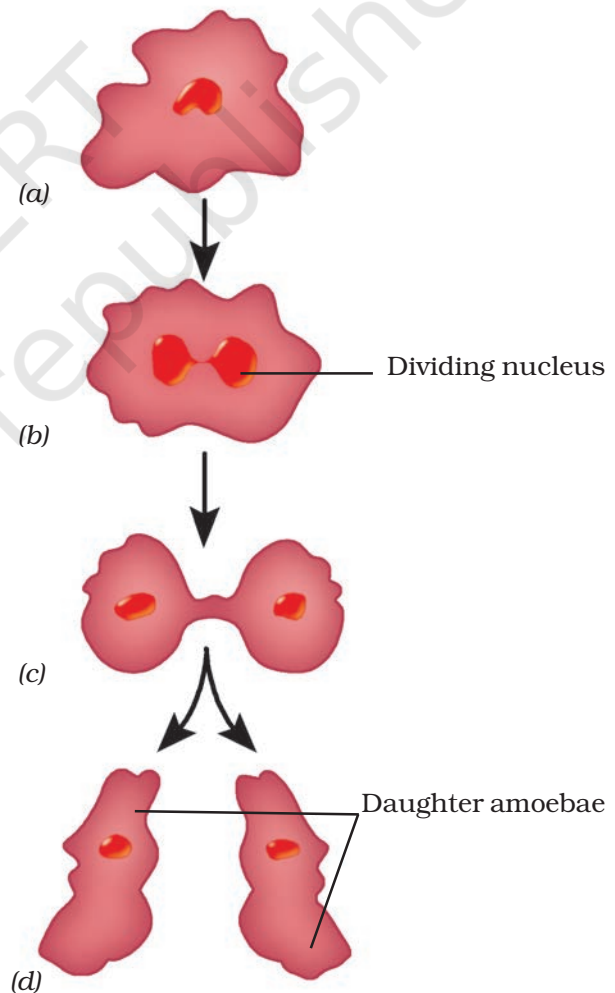

Fig. 9.12 : Binary fission in Amoeba

reproduction in which an animal reproduces by dividing into two individuals is called **binary fission**. Apart from budding and binary fission,

there are other methods by which a single parent reproduces young ones. You will study about these in your higher classes.

Story of Dolly, the Clone

Cloning is the production of an exact copy of a cell, any other living part, or a complete organism. Cloning of an animal was successfully performed for the first time by Ian Wilmut and his colleagues at the Roslin Institute in Edinburgh, Scotland. They successfully cloned a sheep named Dolly [Fig. 9.13 (c)]. Dolly was born on 5th July 1996 and was the first mammal to be cloned.

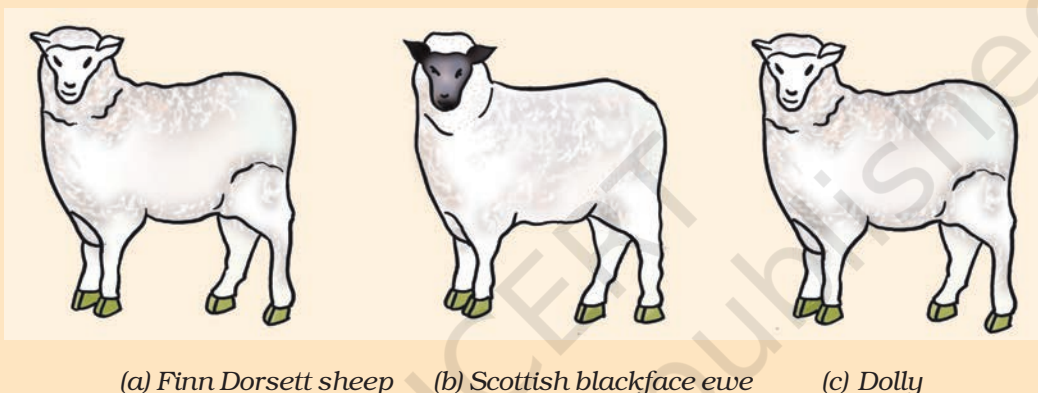

Fig. 9.13

During the process of cloning Dolly, a cell was collected from the mammary gland of a female Finn Dorsett sheep [Fig. 9.13 (a)]. Simultaneously, an egg was obtained from a Scottish blackface ewe [Fig. 9.13 (b)]. The nucleus was removed from the egg. Then, the nucleus of the mammary gland cell from the Finn Dorsett sheep was inserted into the egg of the Scottish blackface ewe whose nucleus had been removed. The egg thus produced was implanted into the Scottish blackface ewe. Development of this egg followed normally and finally Dolly was born. Though Dolly was given birth by the Scottish blackface ewe, it was found to be absolutely identical to the Finn Dorsett sheep from which the nucleus was taken. Since the nucleus from the egg of the Scottish blackface ewe was removed, Dolly did not show any character of the Scottish blackface ewe. Dolly was a healthy clone of the Finn Dorsett sheep and produced several offspring of her own through normal sexual means. Unfortunately, Dolly died on 14th February 2003 due to a certain lung disease.

Since Dolly, several attempts have been made to produce cloned mammals. However, many die before birth or die soon after birth. The cloned animals are many-a-times found to be born with severe abnormalities.

KEYWORDS

**ASEXUAL
REPRODUCTION**

BINARY FISSION

BUDDING

EGGS

EMBRYO

**EXTERNAL
FERTILISATION**

FERTILISATION

FOETUS

**INTERNAL
FERTILISATION**

METAMORPHOSIS

OVIPAROUS ANIMALS

**SEXUAL
REPRODUCTION**

SPERMS

VIVIPAROUS ANIMALS

ZYGOTE

WHAT YOU HAVE LEARNT

- There are two modes by which animals reproduce. These are: (i) Sexual reproduction, and (ii) Asexual reproduction.
- Reproduction resulting from the fusion of male and female gametes is called sexual reproduction.
- The reproductive organs in the female include ovaries, oviducts and uterus.
- The reproductive organs in male include testes, sperm ducts and penis.
- The ovary produces female gametes called ova and the testes produce male gametes called sperms.
- The fusion of ovum and sperm is called fertilisation. The fertilised egg is called a zygote.
- Fertilisation that takes place inside the female body is called internal fertilisation. This is observed in human beings and other animals such as hens, cows and dogs.
- Fertilisation that takes place outside the female body is called external fertilisation. This is observed in frogs, fish, starfish, etc.
- The zygote divides repeatedly to give rise to an embryo.
- The embryo gets embedded in the wall of the uterus for further development.
- The stage of the embryo in which all the body parts are identifiable is called foetus.
- Animals such as human beings, cows and dogs which give birth to young ones are called viviparous animals.
- Animals such as hen, frog, lizard and butterfly which lay eggs are called oviparous animals.
- The transformation of the larva into adult through drastic changes is called metamorphosis.
- The type of reproduction in which only a single parent is involved is called asexual reproduction.
- In hydra, new individuals develop from buds. This method of asexual reproduction is called budding.
- *Amoeba* reproduces by dividing itself into two. This type of asexual reproduction is called binary fission.

Exercises

1. Explain the importance of reproduction in organisms.
2. Describe the process of fertilisation in human beings.
3. Choose the most appropriate answer.
 - (a) Internal fertilisation occurs
 - (i) in female body.
 - (ii) outside female body.
 - (iii) in male body.
 - (iv) outside male body.
 - (b) A tadpole develops into an adult frog by the process of
 - (i) fertilisation
 - (ii) metamorphosis
 - (iii) embedding
 - (iv) budding
 - (c) The number of nuclei present in a zygote is
 - (i) none
 - (ii) one
 - (iii) two
 - (iv) four
4. Indicate whether the following statements are True (T) or False (F).
 - (a) Oviparous animals give birth to young ones. ()
 - (b) Each sperm is a single cell. ()
 - (c) External fertilisation takes place in frog. ()
 - (d) A new human individual develops from a cell called gamete. ()
 - (e) Egg laid after fertilisation is made up of a single cell. ()
 - (f) Amoeba reproduces by budding. ()
 - (g) Fertilisation is necessary even in asexual reproduction. ()
 - (h) Binary fission is a method of asexual reproduction. ()
 - (i) A zygote is formed as a result of fertilisation. ()
 - (j) An embryo is made up of a single cell. ()
5. Give two differences between a zygote and a foetus.
6. Define asexual reproduction. Describe two methods of asexual reproduction in animals.
7. In which female reproductive organ does the embryo get embedded?
8. What is metamorphosis? Give examples.
9. Differentiate between internal fertilisation and external fertilisation.

10. Complete the crossword puzzle using the hints given below.

Across

1. The process of the fusion of the gametes.
6. The type of fertilisation in hen.
7. The term used for bulges observed on the sides of the body of hydra.
8. Eggs are produced here.

Down

2. Sperms are produced in these male reproductive organs.
3. Another term for in vitro fertilisation.
4. These animals lay eggs.
5. A type of fission in amoeba.

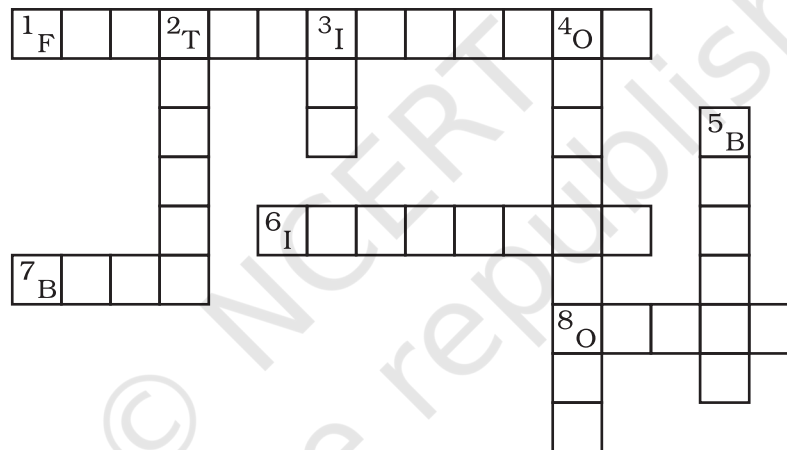

Extended Learning — Activities and Projects

1. Visit a poultry farm. Talk to the manager of the farm and try to find out the answers to the following.
 - (a) What are **layers** and **broilers** in a poultry farm?
 - (b) Do hens lay unfertilised eggs?
 - (c) How can you obtain fertilised and unfertilised eggs?
 - (d) Are the eggs that we get in the stores fertilised or unfertilised?
 - (e) Can you consume fertilised eggs?
 - (f) Is there any difference in the nutritional value of fertilised and unfertilised eggs?

2. Observe live hydra yourself and learn how they reproduce by doing the following activity:

During the summer months collect water weeds from ponds or ditches along with the pond water and put them in a glass jar. After a day or so you may see several hydra clinging to the sides of the jar.

Hydra is transparent, jelly-like and with tentacles. It clings to the jar with the base of its body. If the jar is shaken, the hydra will contract instantly into a small blob, at the same time drawing its tentacles in.

Now take out few hydras from the jar and put them on a watch glass. Using a hand lens or a binocular or dissection microscope, observe the changes that are taking place in their body. Note down your observations.

3. The eggs we get from the market are generally the unfertilised ones. In case you wish to observe a developing chick embryo, get a fertilised egg from the poultry or hatchery which has been incubated for 36 hours or more. You may then be able to see a white disc-like structure on the yolk. This is the developing embryo. Sometimes if the heart and blood vessels have developed you may even see a red spot.
4. Talk to a doctor. Find out how twinning occurs. Look for any twins in your neighbourhood, or among your friends. Find out if the twins are identical or non-identical. Also find out why identical twins are always of the same sex? If you know of any story about twins, write it in your own words.

For more information on animal reproduction, you can visit :

- www.saburchill.com
- www.teenshealth.org/teen/sexual-health

Did You Know?

An interesting organisation is observed in a honey bee hive, a colony of several thousand bees. Only one bee in the colony lays eggs. This bee is called the queen bee. All other female bees are worker bees. Their main job is to build the hive, look after the young and feed the queen bee adequately to keep her healthy so that she can lay eggs. A queen bee lays thousands of eggs. The fertilised eggs hatch into females, while the unfertilised eggs give rise to males, called drones. It is the job of the worker bees to maintain the temperature of the hive at around 35°C to incubate the eggs.

CHAPTER 10 REACHING THE AGE OF ADOLESCENCE



0854CH10

In the previous chapter, you have learnt how animals reproduce. It is only after 'growing up' to a certain age that human beings and many other animals can reproduce. Why can humans reproduce only after a certain age?

In this chapter, you will learn about changes that take place in the human body after which a person becomes capable of reproduction.

In Chapter 9, you have learnt about human reproductive organs. Here, we shall discuss the role that hormones play in bringing about changes that make a child grow into an adult.

10.1 Adolescence and Puberty

Boojho was celebrating his 12th birthday. After his friends left, Boojho and Paheli began chatting with their parents. Paheli studies in an all-girls school. She started laughing. She remarked that many of Boojho's school friends, whom she met after a year, had suddenly shot up in height. Some of them were looking very funny with a hairy line above their lips. Her mother explained that the boys had grown up.

Growth begins from the day one is born. But upon crossing the age of 10 or 11, there is a sudden spurt in growth which becomes noticeable. The changes taking place in the body are part of growing up. They indicate that you are

no longer a child but are on the way to becoming an adult.

I wonder how long this period marked by changes in the body will last!



It is a strange period of life when you are neither a child nor an adult. I wonder whether this period between childhood and adulthood had a special name!



Growing up is a natural process. The period of life, when the body undergoes changes, leading to reproductive maturity, is called **adolescence**. Adolescence begins around the age of 11 and lasts upto 18 or 19 years of age. Since this period covers the 'teens' (13 to 18 or 19 years of age), adolescents are also called 'teenagers'. In girls, adolescence may begin a year or two earlier than in boys. Also, the period of adolescence varies from person to person.

The human body undergoes several changes during adolescence. These changes mark the onset of **puberty**. The most important change which marks puberty is that boys and girls become capable of reproduction. Puberty ends when an adolescent reaches reproductive maturity.



Paheli and Boojho realised that sudden increase in height and hairy line above the lips in boys were signs of adolescence. They wanted to know more about other changes at puberty.



the tallest and who might be the shortest in your class.

10.2 Changes at Puberty

Increase in Height

The most conspicuous change during puberty is the sudden increase in height. At this time the long bones, that is, the bones of the arms and the legs elongate and make a person tall.

Activity 10.1

The following chart gives the average rate of growth in height of boys and girls with age. The figures in columns 2 and 3, give the percentage of the height a person has reached at the age given in column 1. For example, by the age 11, a boy has reached 81% of his probable full height, while a girl has reached 88% of her full height. These figures are only representative and there may be individual variations.

Use the Table for your friends and work out how tall they are likely to be. Find out who is likely to be

Age in Years	% of full height	
	Boys	Girls
8	72%	77%
9	75%	81%
10	78%	84%
11	81%	88%
12	84%	91%
13	88%	95%
14	92%	98%
15	95%	99%
16	98%	99.5%
17	99%	100%
18	100%	100%

Calculation for full height (cm)

$$\frac{\text{Present height (cm)}}{\% \text{ of full height at this age (as given in the chart)}} \times 100$$

Example:

A boy is 9 years old and 120 cm tall. At the end of the growth period he is likely to be

$$\frac{120}{75} \times 100 \text{ cm} = 160 \text{ cm tall}$$

Activity 10.2

Use the data given in Activity 10.1 to draw a graph. Take age on the X-axis and per cent growth in height on the Y-axis. Highlight the point representing your age on the graph. Find out the percentage of height you have already reached. Calculate the height you might eventually reach. Tally your graph with the one given here (Fig. 10.1).

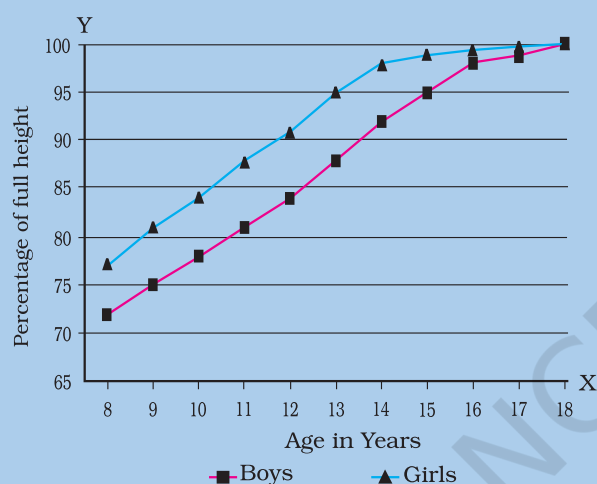

Fig. 10.1 : Graph showing percentage of height with age

Initially, girls grow faster than boys but by about 18 years of age, both reach their maximum height. The rate of growth in height varies in different individuals. Some may grow suddenly at puberty and then slow down, while others may grow gradually.



I am worried. Though I have become taller, my face looks much smaller compared to my body.

There is no need for Paheli to worry. All parts of the body do not grow at the same rate. Sometimes the arms and legs or hands and feet of adolescents look oversized and out of proportion with the body. But soon the other parts catch up and result in a proportionate body.

You must have noticed that height of an individual is more or less similar to that of some family member. This is because height depends on the genes inherited from parents. It is, however, very important to eat the right kind of food during these growing years. This helps the bones, muscles and other parts of the body get adequate nourishment for growth. You will find nutritional needs of adolescents discussed later in the lesson.

Change in Body Shape

Have you noticed that boys in your class have broader shoulders and wider chests than boys in junior classes? This is because they have entered the age of puberty when shoulders generally broaden as a result of growth. In girls, the region below the waist becomes wider.

In boys, the muscles of the body grow more prominently than in the girls. Thus, changes occurring in adolescent boys and girls are different.

Voice Change

Did you notice that sometimes the voice of some of the boys in your class cracks? At puberty, the **voice box** or the **larynx** begins to grow. Boys develop larger voice boxes. The growing voice box in boys can be seen as a protruding part of the throat

called **Adam's apple** (Fig. 10.2). In girls, the larynx is hardly visible from the outside because of its small size. Generally, girls have a high pitched voice, whereas boys have a deep voice. In adolescent boys, sometimes, the muscles of the growing voice box go out of control and the voice becomes hoarse. This state may remain for a few days or weeks after which the voice becomes normal.

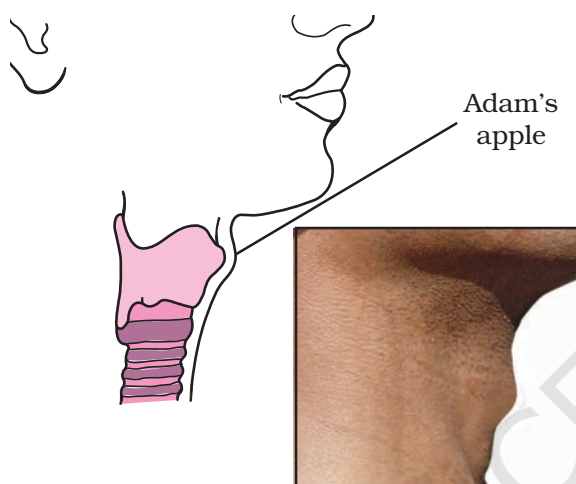

Fig. 10.2 : Adam's apple in a grown up boy



Many of my classmates have a hoarse voice. Now I know why?

Increased Activity of Sweat and Sebaceous Glands

During puberty the secretion of sweat glands and sebaceous glands (oil glands) increases. Many young people get acne

A few glands such as sweat glands, oil glands and salivary glands release their secretions through ducts. Endocrine glands release hormones directly into the bloodstream. So, they are also termed ductless glands.

and pimples on the face at this time because of the increased activity of these glands in the skin.

Development of Sex Organs

Look up Fig. 9.1 and 9.3 of the previous lesson which show sex organs of humans. At puberty, male sex organs like the testes and penis develop completely. The testes also begin to produce sperms. In girls, the ovaries enlarge and eggs begin to mature. Also ovaries start releasing mature eggs.

Reaching Mental, Intellectual and Emotional Maturity

Adolescence is also a period of change in a person's way of thinking. Adolescents are more independent than before and are also self conscious. Intellectual development takes place and they tend to spend considerable time thinking. In fact, it is often the time in one's life when the brain has the greatest capacity for learning. Sometimes, however, an adolescent may feel insecure while trying to adjust to the changes in the body and mind. But as adolescent learners, you should know that there is no reason to feel insecure. These changes are a natural part of growing up.

10.3 Secondary Sexual Characters

You have learnt in Chapter 9, that testes and ovaries are the reproductive organs. They produce the gametes, that is, sperms and ova. In girls, breasts begin to develop at puberty

and boys begin to grow facial hair, that is, moustaches and beard. As these features help to distinguish the male from the female they are called **secondary sexual characters**. Boys also develop hair on their chest. In both, boys and girls, hair grows under the arms and in the region above the thighs or the pubic region.

Both Boojho and Paheli wish to know what initiates changes at puberty.

The changes which occur at adolescence are controlled by **hormones**. Hormones are chemical substances. These are secretions from **endocrine glands**, or endocrine system. The **male hormone** or **testosterone** begins to be released by the testes at the onset of puberty. This causes changes in boys about which you have just learnt, for example, the growth of facial hair. Once puberty is reached in girls, ovaries begin to produce the **female hormone** or **estrogen** which makes the breasts develop. Milk secreting glands or mammary glands develop inside the breasts. The production of these hormones is under the control of another hormone secreted from an endocrine gland called **pituitary gland**.

10.4 Role of Hormones in Initiating Reproductive Function

Endocrine glands release hormones into the bloodstream to reach a particular body part called **target site**. The target site responds to the hormone. There are many endocrine glands or ductless glands in the body.

The testes and ovaries secrete sex hormones. You have just learnt that these hormones are responsible for the male and female secondary sexual characters. Further, the sex hormones are under the control of hormones from the pituitary gland (Fig. 10.3). The pituitary secretes many hormones, one of which makes ova mature in the ovaries and sperms form in the testes.

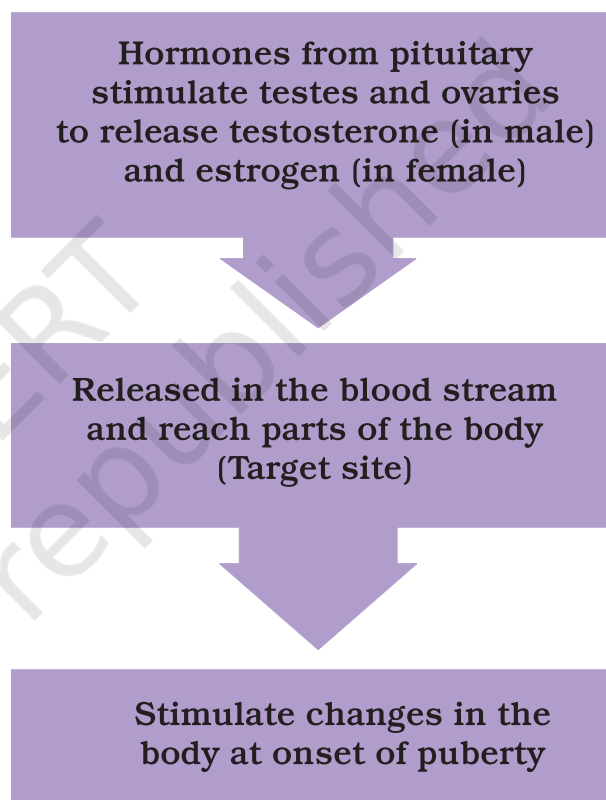

Fig. 10.3 : The onset of puberty is controlled by hormones

Paheli and Boojho have now understood that puberty marks the beginning of the reproductive period when one becomes capable of reproduction. But they want to know if reproductive life, once begun, continues, or it ends some time.

10.5 Reproductive Phase of Life in Humans

Adolescents become capable of reproduction when their testes and ovaries begin to produce gametes. The capacity for maturation and production of gametes lasts for a much longer time in males than in females.

In females, the reproductive phase of life begins at puberty (10 to 12 years of age) and generally lasts till the age of approximately 45 to 50 years. The ova begin to mature with the onset of puberty. One ovum matures and is released by one of the ovaries once in about 28 to 30 days. During this period, the wall of the uterus becomes thick so as to receive the egg, in case it is fertilised and begins to develop. This results in pregnancy. If fertilisation does not occur, the released egg, and the thickened lining of the uterus along with its blood vessels are shed off. This causes bleeding in women which is called **menstruation**. Menstruation occurs once in about 28 to 30 days. The first menstrual flow begins at puberty and is termed **menarche**. At 45 to 50 years of age, the menstrual cycle stops. Stoppage of menstruation is termed **menopause**. Initially, menstrual cycle may be irregular. It takes some time to become regular.



Paheli says that the reproductive life of a woman lasts from menarche to menopause. Is she right?

Menstrual cycle is controlled by hormones. The cycle includes the maturation of the egg, its release, thickening of uterine wall and its breakdown if pregnancy does not occur. In case the egg is fertilised it begins to divide and then gets embedded in the uterus for further development as you have learnt in Chapter 9 (Fig. 9.8).

10.6 How is the Sex of the Baby Determined?



I heard my mother and my aunt talking about my cousin who is going to have a baby. They were discussing whether she would give birth to a boy or a girl. I wonder what makes the fertilised egg develop either into a boy or a girl!

Boy or Girl?

Inside the fertilised egg or zygote is the instruction for determining the sex of the baby. This instruction is present in the thread-like structures, called **chromosomes** in the fertilised egg. Recall from Chapter 8, that chromosomes are present inside the nucleus of every cell. All human beings have 23 pairs of chromosomes in the nuclei of their cells. Two chromosomes out of these are the **sex chromosomes**, named X and Y. A female has two X chromosomes, while a male has one X and one Y chromosome. The gametes (egg and sperm) have only one set of chromosomes. The unfertilised egg always has one X chromosome. But

sperms are of two kinds. One kind has an X chromosome, and the other kind has a Y chromosome.

See Fig. 10.4. When a sperm containing X chromosome fertilises the egg, the zygote would have two X chromosomes and develop into a female child. If the sperm contributes a Y chromosome to the egg (ovum) at fertilisation, the zygote would develop into a male child.

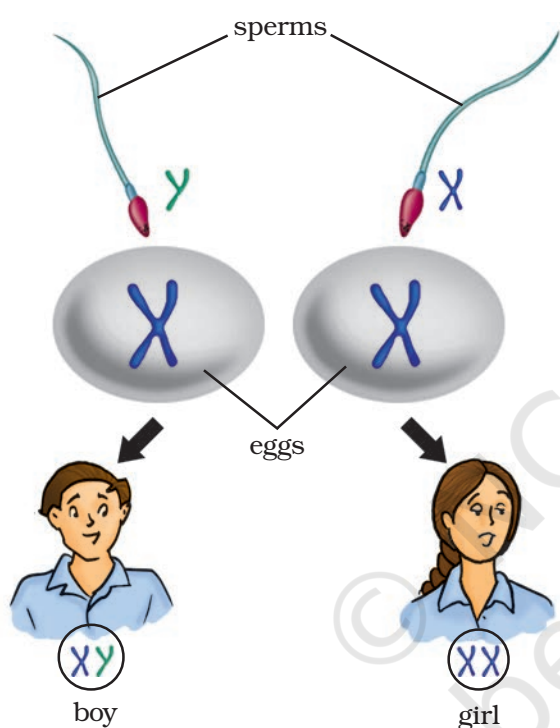

Fig. 10.4 : Sex determination in humans

Now you know that the sex chromosomes of the father determine the sex of an unborn baby. The belief that the mother is responsible for the sex of her baby is completely wrong and to blame her for this is totally unjustified.

10.7 Hormones other than Sex Hormones

Look at Fig. 10.3 again. The hormones secreted by the pituitary stimulate testes

and ovaries to produce their hormones. You have already learnt that the pituitary gland is an endocrine gland. It is attached to the brain.

Apart from the pituitary, the testes and the ovaries, there are other endocrine glands in the body such as thyroid, pancreas and adrenals (Fig. 10.5).

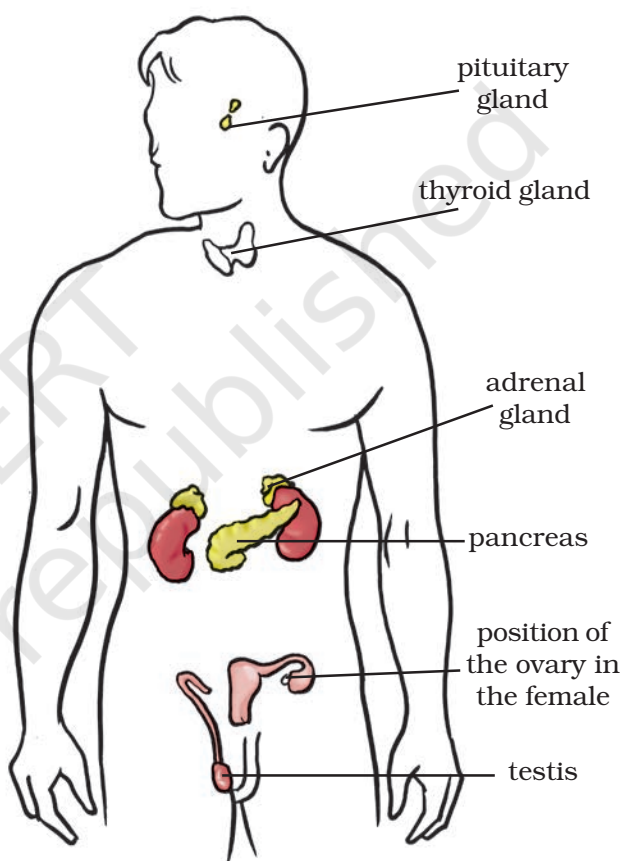

Fig. 10.5 : Position of endocrine glands in the human body

Boojho and Paheli had once visited their aunt who was a doctor and remembered that a boy named Kaka had a very big and bulging throat. Their aunt had told them that Kaka was suffering from 'goitre', a disease of the **thyroid gland**. Kaka's thyroid gland was not producing the hormone **thyroxine**.

Their aunt also told them that their uncle was suffering from 'diabetes' because his pancreas was not producing the hormone **insulin** in sufficient quantities. Boojho and Paheli then asked their aunt about the adrenal glands, which are also shown in the chart hung on the wall of her clinic. The aunt told them that adrenal glands secrete hormones which maintain the correct salt balance in the blood. Adrenals also produce the hormone **adrenalin**. It helps the body to adjust to stress when one is very angry, embarrassed or worried.

Thyroid and adrenals secrete their hormones when they receive orders from the pituitary through its hormones. Pituitary also secretes **growth hormone** which is necessary for the normal growth of a person.



Are there hormones in other animals also? Have they any role to play in reproduction?

10.8 Role of Hormones in Completing the Life History of Insects and Frogs

You have already learnt about the life history of the silk moth and the frog. The caterpillar has to pass through various stages to become an adult moth. Recall from Class VII the stages of the life history of the silk moth. Similarly, the tadpole passes through certain stages to become a frog (Chapter 9).

This change from larva to adult is called **metamorphosis** (Fig. 9.10). Metamorphosis in insects is controlled by **insect hormones**. In a frog, it is controlled by **thyroxine**, the hormone produced by **thyroid**. Thyroxine production requires the presence of iodine in water. If the water in which the tadpoles are growing does not contain sufficient iodine, the tadpoles cannot become adults.



If people do not have enough iodine in their diet, will they get goitre caused by lack of thyroxine?

Activity 10.3

Collect information from magazines or from doctors and prepare a note on the importance of consuming iodised salt. You can also look for this information on the internet.

10.9 Reproductive Health

The physical and mental well being of an individual is regarded as an individual's health. To keep the body healthy, every human being, at any age, needs to have a balanced diet. The person must also observe personal hygiene and undertake adequate physical exercise.

During adolescence, however, these become even more essential as the body is growing.

Nutritional Needs of the Adolescents

Adolescence is a stage of rapid growth and development. Hence the diet for an

adolescent has to be carefully planned. You have already learnt what a **balanced diet** is. Recall that a balanced diet means that the meals include proteins, carbohydrates, fats and vitamins in requisite proportions. Our Indian meal of *roti*/rice, *dal* (pulses) and vegetables is a balanced meal. Milk is a balanced food in itself. Fruits also provide nourishment. For infants, mother's milk provides all the nourishment that they need.

Iron builds blood and iron-rich food such as leafy vegetables, jaggery, meat, citrus, Indian gooseberry (*amla*) are good for adolescents.

Check items for lunch and dinner in your meal. Is the meal balanced and nutritious? Does it include cereals which give energy and milk, meat, nuts and pulses which provide proteins for growth? Also, does it include fats and sugar that give energy? What about fruits and vegetables which are protective foods? **Chips and packed or tinned snacks, though very tasty should never replace regular meals as they do not have adequate nutritional value.**

Activity 10.4

Make a group with your friends. Write down the items of food in your breakfast, lunch and dinner you had on the previous day. Identify the items responsible for proper growth. Also identified the junk food that you consumed the previous day.

Activity 10.5

Get ideas from the pictures given in Fig.10.6. Prepare charts or posters and paste them in the class so that you are aware of the diet for adolescents. You may use your creative ideas and present it like an advertisement. You may even organise a competition on this topic.

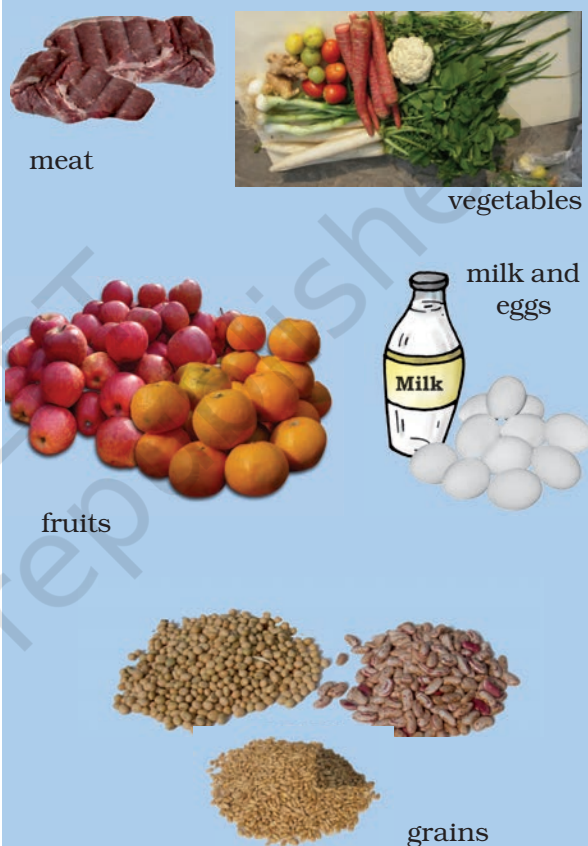

Fig. 10.6 : Nutritious items of food

Personal Hygiene

Everyone should have a bath at least once everyday. It is more necessary for teenagers because the increased activity of sweat glands sometimes makes the body smelly. All parts of the body should be washed and cleaned everyday. If

cleanliness is not maintained there are chances of catching **bacterial** infection. Girls should take special care of cleanliness during the time of menstrual flow. They should keep track of their menstrual cycle and be prepared for the onset of menstruation. Use sanitary napkin or clean homemade pads. Change pads after every 4–5 hours as per the requirement.

Physical exercise

Walking and playing in fresh air keeps the body fit and healthy. All young boys and girls should take walks, exercise and play outdoor games.

Myths, Taboos, Do's and Don'ts

You have learnt here and from Chapter 9 the scientific facts related to human reproduction. There are many wrong notions which you should now be able to discard as informed adolescents. For example, there are myths and taboos regarding bodily changes that adolescents experience. Some of these are given below and you can now argue why these are myths and not facts.

1. A girl becomes pregnant if she looks at boys during menstruation.
2. The mother is responsible for the sex of her child.
3. A girl should not be allowed to work in the kitchen during menstruation.

You may come across many other myths and taboos. Discard them.

Activity 10.6

Collect data on the number of children in your class who exercise regularly and who do not exercise regularly. Did you notice any difference in their fitness and health? Prepare a report on the benefits of regular exercise.

Say “NO” to Drugs

Adolescence is a period of much activity in the body and mind which is a normal part of growing up. So do not feel confused or insecure. If anybody suggests that you will get relief if you take some drugs, just say ‘No’ unless prescribed by the doctor. Drugs are addictive. If you take them once, you feel like taking them again and again. They harm the body in the long run. They ruin health and happiness.

You must have heard about AIDS which is caused by a dangerous virus, HIV. This virus can pass on to a normal person from an infected person by sharing the syringes used for injecting drugs. It can also be transmitted to an infant from the infected mother through her milk. The virus can also be transmitted through sexual contact with a person infected with HIV.

Adolescent Pregnancy

You might be knowing that in our country, the legal age for marriage is 18 years for girls and 21 years for boys. This is because teenage mothers are not prepared mentally or physically for motherhood. Early marriage and motherhood cause health problems in the mother and the child. It also curtails employment opportunities for the young woman and may cause mental agony as she is not ready for responsibilities of motherhood.

KEYWORDS

ADAM'S APPLE

ADOLESCENCE

ADRENALIN

BALANCED DIET

ENDOCRINE GLANDS

ESTROGEN

HORMONES

INSULIN

LARYNX

PITUITARY GLAND

PUBERTY

REPRODUCTIVE
HEALTH

SECONDARY SEXUAL
CHARACTERS

SEX CHROMOSOMES

TARGET SITE

TESTOSTERONE

THYROXINE

VOICE BOX

WHAT YOU HAVE LEARNT

- Humans become capable of reproduction after puberty sets in. Children between the ages of 11 and 19 years are called adolescents.
- The onset of puberty brings about growth of the reproductive organs. Hair grows at various places on the body. Breasts develop in girls and facial hair (moustache and beard) appear in boys. Voice of boys becomes hoarse as voice box enlarges during adolescence.
- Children gain height during adolescence.
- The onset of puberty and maturity of reproductive parts are controlled by hormones.
- Hormones are secretions of endocrine glands which pour them directly into the blood stream.
- Pituitary gland secretes hormones which include growth hormone and hormones that make other glands such as the testes, ovaries, thyroids and adrenals, secrete hormones. Pancreas secretes insulin, thyroid produces thyroxine and adrenals produce adrenalin.
- Testosterone is the male hormone and estrogen, the female hormone. The uterine wall in females prepares itself to receive the developing fertilised egg. In case there is no fertilisation, the thickened lining of the uterine wall breaks down and goes out of the body along with blood. This is called menstruation.
- Sex of the unborn child depends on whether the zygote has XX or XY chromosomes.
- It is important to eat balanced food and maintain personal hygiene during adolescence.

Exercises

1. What is the term used for chemical secretions of endocrine glands responsible for changes taking place in the body?
2. Define adolescence.
3. What is menstruation? Explain.
4. List changes in the body that take place at puberty.
5. Prepare a Table having two columns depicting names of endocrine glands and hormones secreted by them.
6. What are sex hormones? Why are they named so? State their function.
7. Choose the correct option.
 - (a) Adolescents should be careful about what they eat, because
 - (i) proper diet develops their brains.
 - (ii) proper diet is needed for the rapid growth taking place in their body.
 - (iii) adolescents feel hungry all the time.
 - (iv) taste buds are well developed in teenagers.
 - (b) Reproductive age in women starts when their
 - (i) menstruation starts.
 - (ii) breasts start developing.
 - (iii) body weight increases.
 - (iv) height increases.
 - (c) The right meal for adolescents consists of
 - (i) chips, noodles, coke.
 - (ii) *chapati, dal, vegetables.*
 - (iii) rice, noodles and burger.
 - (iv) vegetable cutlets, chips and lemon drink.
8. Write notes on—
 - (a) Adam's apple.
 - (b) Secondary sexual characters.
 - (c) Sex determination in the unborn baby.

9. Word game : Use the clues to work out the words.

Across

3. Protruding voice box in boys
4. Glands without ducts
7. Endocrine gland attached to brain
8. Secretion of endocrine glands
9. Pancreatic hormone
10. Female hormone

Down

1. Male hormone
2. Secretes thyroxine
3. Another term for teenage
5. Hormone reaches here through blood stream
6. Voice box
7. Term for changes at adolescence

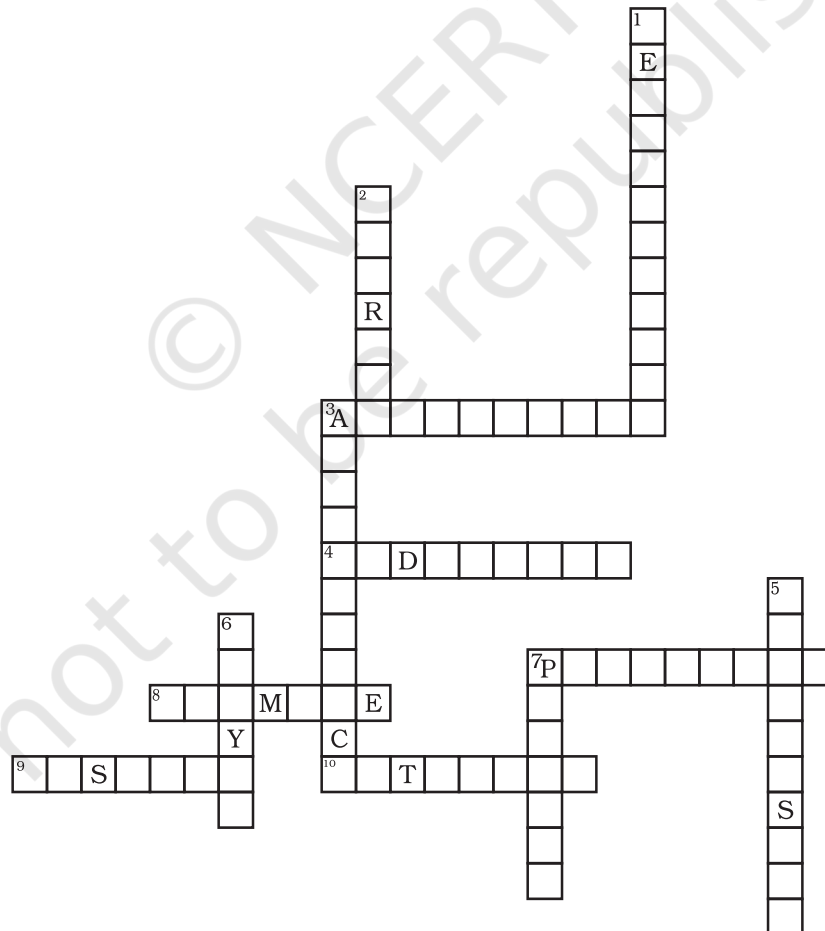

10. The table below shows the data on likely heights of boys and girls as they grow in age. Draw graphs showing height and age for both boys and girls on the same graph paper. What conclusions can be drawn from these graphs?

Age (Years)	Height (cm)	
	Boys	Girls
0	53	53
4	96	92
8	114	110
12	129	133
16	150	150
20	173	165

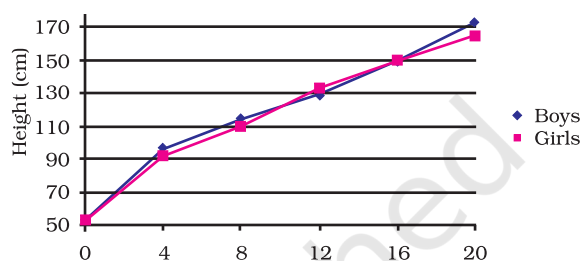

Extended Learning — Activities and Projects

- Find out from your elder relatives about their awareness of the legal status of early marriage. You yourself may get information on it from your teacher, parents, a doctor or the internet. Write a two-minute speech explaining why early marriage is not good for the couple.
- Collect newspaper cuttings and information in magazines about HIV/AIDS. Write a one page article of 15 to 20 sentences on HIV/AIDS.
- In our country, according to 2011 census, there are 940 adolescent females for every 1000 males. Find out.
 - the concerns of the community regarding this low ratio. Remember that the chance of having a boy or a girl is equal.
 - what amniocentesis is and how useful this technique is. Why is its use for identification of sex of the unborn child banned in India?
- Put your ideas together and write a short note on the importance of knowing facts about reproduction.

For more information visit :

- www.teenshealth.org/teen/sexual_health/
- www.adolescenthealth.com



In Class VII, you have learnt how objects move. Do you recall how we can decide whether an object is moving faster than the other? What does the distance moved by an object in unit time indicate? You also know that a moving object like a ball rolling on the ground slows down. Sometimes it may change its direction of motion. It is also possible that the ball may slow down and also change its direction. Have you ever wondered what makes an object slow down or go faster, or change its direction of motion?

Let us recall some of our everyday experiences. What do you do to make a football move? What do you do to make a moving ball move faster? How does a goalkeeper stop a ball? A hockey player changes the direction of the moving ball with a flick of the stick. How do fielders stop a ball hit

by a batsman? (Fig. 11.1). In all these situations the ball is either made to move faster or slower or its direction of motion is changed.

We often say that a force has been applied on a ball when it is kicked, pushed, thrown or flicked. What is a force? What can it do to bodies on which it is applied? We shall seek answers to such questions in this chapter.

11.1 Force – A Push or a Pull

Actions like picking, opening, shutting, kicking, hitting, lifting, flicking, pushing, pulling are often used to describe certain tasks. Each of these actions usually results in some kind of change in the state of motion of an object. Can these terms be replaced with one or more terms? Let us find out.

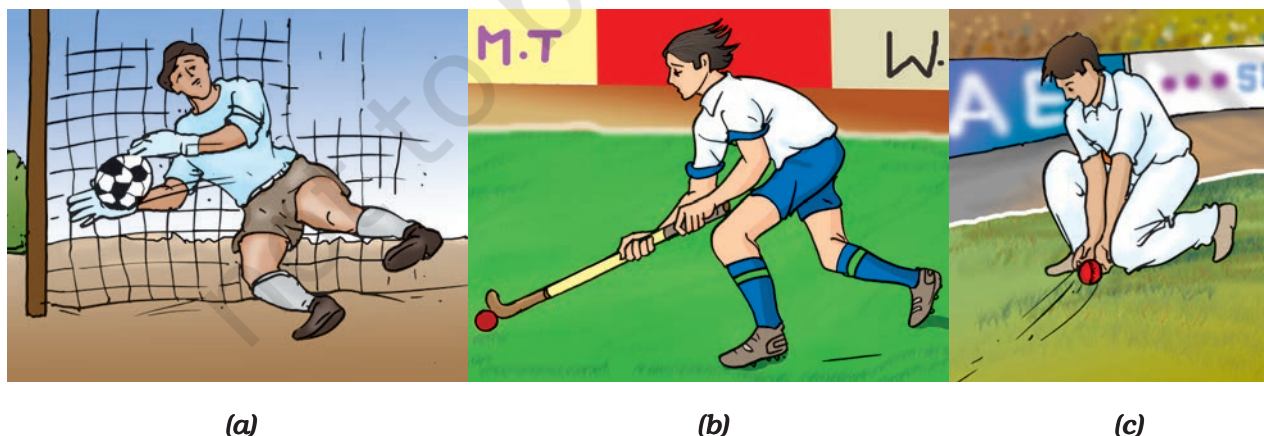

Fig. 11.1 : (a) A goal keeper saving a goal, (b) A hockey player flicking a ball, and (c) A fielder stopping a ball

Activity 11.1

Table 11.1 gives some examples of familiar situations involving motion of objects. You can add more such situations or replace those given here. Try to identify action involved in each case as a push and/or a pull and record your observations. One example has been given to help you.

Table 11.1 : Identifying Actions as Push or Pull

S. No	Description of the situation	Action : (pushing/ pulling/picking/ hitting/lifting/ lowering/flying/ kicking/ throwing/shutting/ flicking)				Action can be grouped as a	
		Pushing	Pulling	Lifting	—	Push	Pull
1.	Moving a book placed on a table	Pushing	Pulling	Lifting	—	Yes	Yes
2.	Opening or shutting a door						
3.	Drawing a bucket of water from a well						
4.	A football player taking a penalty kick						
5.	A cricket ball hit by a batsman						
6.	Moving a loaded cart						
7.	Opening a drawer						

Do you notice that each of the actions can be grouped as a pull or a push or both? Can we infer from this, that to move an object, it has to be pushed or pulled?

In science, a push or a pull on an object is called a **force**. Thus, we can say that the motion imparted to objects was due to the action of a force. When does a force come into play? Let us find out.



I learnt in Class VI that a magnet attracts a piece of iron towards it. Is attraction also a pull? What about repulsion between similar poles of two magnets? Is it a pull or a push?

11.2 Forces are due to an Interaction

Suppose a man is standing behind a stationary car [Fig.11.2(a)]. Will the car move due to his presence? Suppose the man now begins to push the car [Fig.11.2(b)], that is, he applies a force on it. The car may begin to move in the



Fig.11.2(a) : A man standing behind a stationary car



Fig.11.2 (b) : A car being pushed by a man

direction of the applied force. Note that the man has to push the car to make it move.



Fig11.3 (a) : Who is pushing whom?

Fig. 11.3 shows three situations that may be familiar to you. Can you decide who is pulling and who is pushing in these cases? In Fig. 11.3 (a), both the girls appear to push each other while

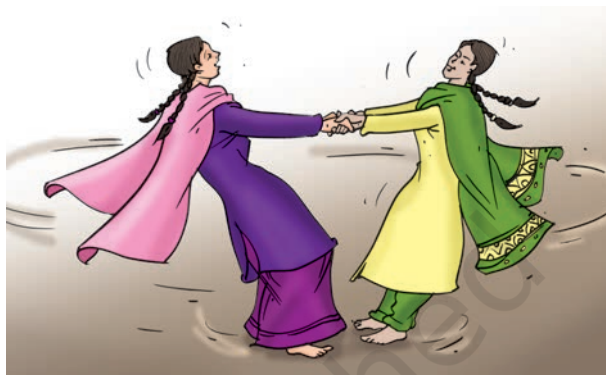

Fig 11.3 (b) : Who is pulling whom?

the pair of girls in Fig. 11.3 (b) are trying to pull each other. Similarly, the cow and the man in Fig. 11. 3(c) appear to



Fig 11.3 (c) : Who is pulling whom?

pull each other. The girls in the two situations shown here are applying force on each other. Is it also true for the man and the cow?

From these examples, we can infer that at least two objects must interact for a force to come into play. Thus, an interaction of one object with another object results in a force between the two objects.

11.3 Exploring Forces

Let us try to learn more about forces.

Activity 11.2

Choose a heavy object like a table or a box, which you can move only by pushing hard. Try to push it all by yourself. Can you move it? Now ask one of your friends to help you in pushing it in the same direction [Fig. 11.4(a)]. Is it easier to move it now? Can you explain why?

Now push the same object, but ask your friend to push it from the opposite side [Fig. 11.4 (b)]. Does the object move? If it does, note the direction in which it moves. Can you guess which one of you is applying a larger force?

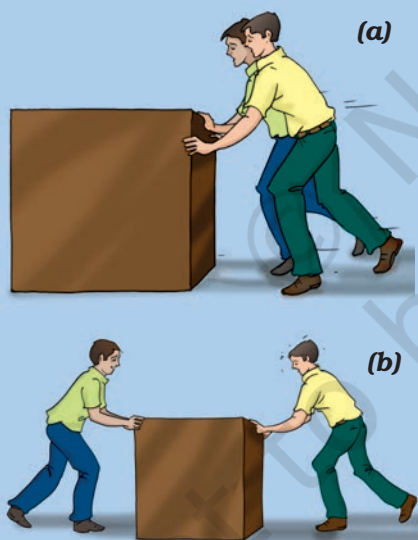

Fig. 11.4 : Two friends pushing a heavy load (a) in the same direction, (b) in opposite direction

Have you ever seen a game of tug-of-war? In this game two teams pull at a rope in opposite directions (Fig. 11.5). Members of both the teams try to pull the



Fig. 11.5 : The rope may not move if the two teams pull at it with equal force

rope in their direction. Sometimes the rope simply does not move. Is it not similar to the situation shown in Fig. 11.3 (b)? The team that pulls harder, that is, applies a larger force, finally wins the game.

What do these examples suggest about the nature of force?

Forces applied on an object **in the same direction add** to one another. Now recall what happened when you and your friend pushed the heavy box in the same direction in Activity 11.2.

If the two forces act in the opposite directions on an object, the net force acting on it is the **difference between the two forces**. What did you observe in Activity 11.2 when both of you were pushing the heavy box from opposite directions?

Recall that in the tug-of-war when two teams pull equally hard, the rope does not move in any direction.

So, we learn that a force could be larger or smaller than the other or equal to each other. The strength of a force is usually expressed by its **magnitude**. We have also to specify the direction in which a force acts. Also, if the direction or the magnitude of the applied force changes, its effect also changes.



Does it mean that the net force on an object is zero if the two forces acting on it in opposite directions are equal?

In general, more than one force may be acting on an object. However, the effect on the object is due to the net force acting on it.

11.4 A Force can Change the State of Motion

Let us now find out what happens when a force acts on an object.

Activity 11.3

Take a rubber ball and place it on a level surface such as a table top or a concrete floor. Now, gently push the ball along the level surface (Fig. 11.6). Does the ball begin to move? Push the ball again while it is still moving. Is there any change in its speed? Does it increase or decrease?

Next, place your palm in front of the moving ball. Remove your palm as soon as the moving ball touches it. Does your palm apply a force on the ball? What happens to the speed of the ball now? Does it increase or decrease? What would happen if you let your palm hold the moving ball?

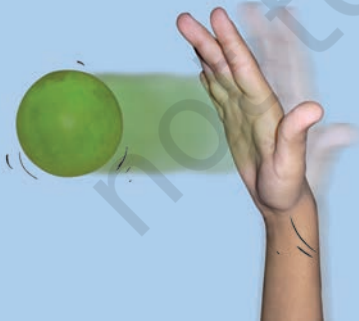

Fig. 11.6 : A ball at rest begins to move when a force is applied on it

You might recall similar situations. For example, while taking a penalty kick in football, the player applies a force on the ball. Before being hit, the ball was at rest and so its speed was zero. The applied force makes the ball move towards the goal. Suppose, the goalkeeper dives or jumps up to save the goal. By his action the goalkeeper tries to apply a force on the moving ball. The force applied by him can stop or deflect the ball, saving a goal being scored. If the goalkeeper succeeds in stopping the ball, its speed decreases to zero.

These observations suggest that a force applied on an object may change its speed. If the force applied on the object is in the direction of its motion, the speed of the object increases. If the force is applied in the direction opposite to the direction of motion, then it results in a decrease in the speed of the object.



I have seen children competing with one another in moving a rubber tyre or a ring by pushing it (Fig. 11.7). I now understand why the speed of the tyre increases whenever it is pushed.



Fig. 11.7 : To move a tyre faster it has to be pushed repeatedly

Paheli is curious to know whether application of a force can only change the speed of an object. Let us find out.

Activity 11.4

Take a ball and place it on a level surface as you did in Activity 11.3. Make the ball move by giving it a push [Fig. 11.8(a)]. Now place a ruler in its path as shown in Fig. 11.8(b). In doing so, you would apply a force on the moving ball. Does the ball continue to move in the same direction after it strikes the ruler? Repeat the activity and try to obstruct the moving ball by placing the ruler in such a way that it makes different angles to its path. In each case note your observations about the direction of motion of the ball after it strikes the ruler.

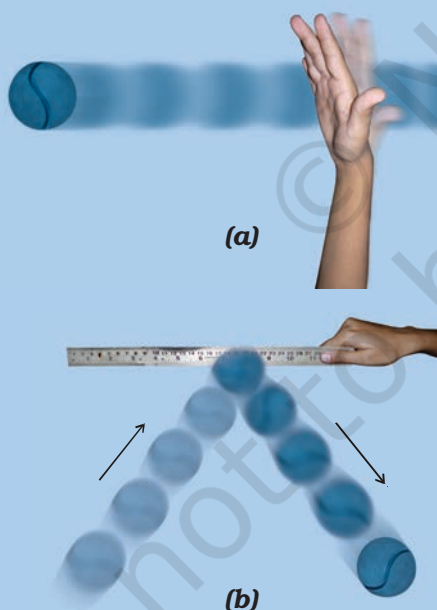

Fig. 11.8 :(a) A ball set in motion by pushing it along a level surface and (b) the direction of motion of the ball after it strikes the ruler placed in its path

Let us consider some more examples. In a game of volleyball, players often push the moving ball to their team mates to make a winning move. Sometimes the ball is returned to the other side of the court by pushing or smashing it. In cricket, a batsman plays his or her shot by applying a force on the ball with the bat. Is there any change in the direction of motion of the ball in these cases? In all these examples the speed and the direction of the moving ball change due to the application of a force. Can you give a few more examples of this kind?

A change in either the speed of an object, or its direction of motion, or both, is described as a **change in its state of motion**. Thus, a force may bring a **change in the state of motion of an object**.

State of Motion

The state of motion of an object is described by its speed and the direction of motion. The state of rest is considered to be the state of zero speed. An object may be at rest or in motion; both are its states of motion.

Does it mean that the application of a force would always result in a change in the state of motion of the object? Let us find out.





It is common experience that many a time application of force does not result in a change in the state of motion. For example, a heavy box may not move at all even if you apply the maximum force that you can exert. Again, no effect of force is observed when you try to push a wall.

11.5 Force can Change the Shape of an Object

Activity 11.5

Some situations have been given in Column 1 of Table 11.2 in which objects are not free to move. Column 2 of the Table suggests the manner in which a force can be applied on each object while Column 3 shows a diagram of the action. Try to observe the effect of force in as many situations as possible. You can also add similar situations using available material from your environment. Note your observations in Columns 4 and 5 of the Table.

Table 11.2 : Studying the Effect of Force on Objects

Description of Situation	How to Apply Force	Diagram	Action of Force			
			Change in State of Motion		Change in Shape	
			Yes	No	Yes	No
A lump of dough on a plate.	Pressing it down with your hands.					
Spring fixed to the seat of a bicycle.	By sitting on the seat.					
A rubber band suspended from a hook/nail fixed on a wall.	By hanging a weight or by pulling its free end.					
A plastic or metal scale placed between two bricks.	By putting a weight at the centre of the scale.					

What do you conclude from the observations noted in Table 11.2? What happens when you apply a force on an inflated balloon by pressing it between your palms? What happens to the shape of a ball of dough when it is rolled to make a *chapati*? What happens when you press a rubber ball placed on a table? In all these examples you saw that the application of **force on an object may change its shape**.

Having performed all the above activities, you would have realised that a force

- may make an object move from rest.
- may change the speed of an object if it is moving.
- may change the direction of motion of an object.
- may bring about a change in the shape of an object.
- may cause some or all of these effects.

While a force may cause one or more of these effects, it is important to remember that none of these actions can take place without the action of a force. Thus, an object cannot move by itself, it cannot change speed by itself, it cannot change direction by itself and its shape cannot change by itself.

11.6 Contact Forces

Muscular Force

Can you push or lift a book lying on a table without touching it? Can you lift a bucket of water without holding it? Generally, to apply a force on an object, your body has to be in contact with the object. The contact may also be with the

help of a stick or a piece of rope. When we push an object like a school bag or lift a bucket of water, where does the force come from? This force is caused by the action of muscles in our body. The force resulting due to the action of muscles is known as the **muscular force**.

It is the muscular force that enables us to perform all activities involving movement or bending of our body. In Class VII you have learnt that in the process of digestion the food gets pushed through the alimentary canal. Could it be a muscular force that does it? You also know that lungs expand and contract while we inhale and exhale air during breathing. Where are these muscles located which make breathing possible? Can you list a few more examples of the force exerted by the muscles in our body?

Animals also make use of muscular force to carry out their physical activities and other tasks. Animals like bullocks, horses, donkeys and camels are used to perform various tasks for us. In performing these tasks they use muscular force (Fig. 11.9).



Fig.11.9 : Muscular force of animals is used to carry out many difficult tasks

Since muscular force can be applied only when it is in contact with an object, it is also called a **contact force**. Are there other types of contact forces? Let us find out.

Friction

Recall some of your experiences. A ball rolling along the ground gradually slows down and finally comes to rest. When we stop pedalling a bicycle, it gradually slows down and finally comes to a stop. A car or a scooter also comes to rest once its engine is switched off. Similarly, a boat comes to rest if we stop rowing it. Can you add some more such experiences?

In all these situations no force appears to be acting on the objects, yet their speed gradually decreases and they come to rest after some time. What causes a change in their state of motion? Could some force be acting on them! Can you guess the direction in which the force must be acting in each case?

The force responsible for changing the state of motion of objects in all these examples is the force of **friction**. It is the force of friction between the surface of the ball and the ground that brings the moving ball to rest. Similarly, friction between water and the boat brings it to a stop once you stop rowing.

The force of friction always acts on all the moving objects and its direction is always opposite to the direction of motion. Since the force of friction arises due to contact between surfaces, it is also an example of a contact force. You will learn more about this force in Chapter 12.

You may be wondering whether it is essential for the agent applying a force

on an object to be always in contact with it. Let us find out.

11.7 Non-contact Forces

Magnetic Force

Activity 11.6

Take a pair of bar magnets. Place the longer side of one of the magnets over three round shaped pencils or wooden rollers as shown in Fig.11.10. Now bring one end of the other magnet near the end of the magnet placed on the rollers. Make sure that the two magnets do not touch each other. Observe what happens. Next, bring the other end of the magnet near the same end of the magnet placed on the rollers (Fig.11.10). Note what happens to the magnet placed on the rollers every time another magnet is brought near it.

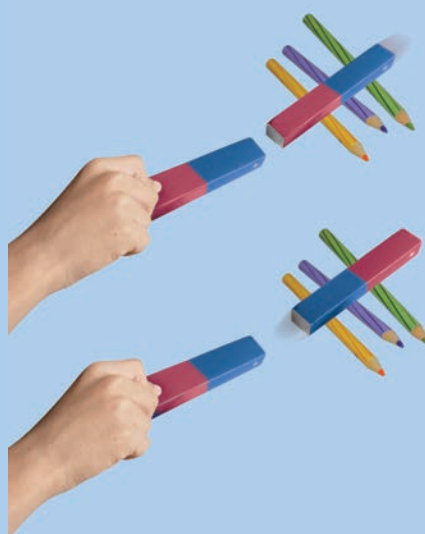

Fig.11.10 : Observing attraction and repulsion between two magnets

Does the magnet on the rollers begin to move when the other magnet is brought near it? Does it always move in the direction of the approaching magnet? What do these observations suggest? Does it mean that some force must be acting between the two magnets?

You have learnt in Class VI that like poles of two magnets repel each other and unlike poles attract each other. Attraction or repulsion between objects can also be seen as another form of pull or push. Do you have to bring the magnets in contact for observing the force between them? A magnet can exert a force on another magnet without being in contact with it. The force exerted by a magnet is an example of a **non-contact force**.

Similarly, the force exerted by a magnet on a piece of iron is also a non-contact force.

Electrostatic Force

Activity 11.7

Take a plastic straw and cut it into nearly two equal pieces. Suspend one of the pieces from the edge of a table with the help of a piece of thread (Fig. 11.11). Now hold the other piece of straw in your hand and rub its free end with a sheet of paper. Bring the rubbed end of the straw near the suspended straw. Make sure that the two pieces do not touch each other. What do you observe?

Next, rub the free end of the suspended piece of straw with a sheet of paper. Again, bring the piece of straw that was rubbed earlier with paper near the free end of the suspended straw. What do you observe now?

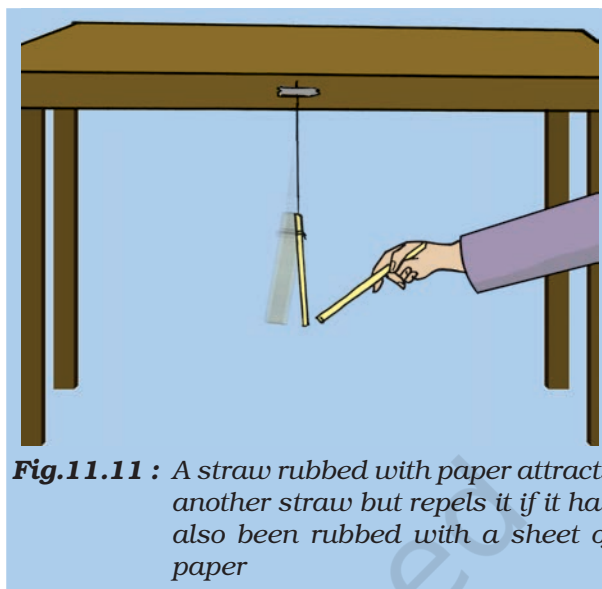

Fig.11.11 : A straw rubbed with paper attracts another straw but repels it if it has also been rubbed with a sheet of paper

A straw is said to have acquired electrostatic charge after it has been rubbed with a sheet of paper. Such a straw is an example of a charged body.

The force exerted by a charged body on another charged or uncharged body is known as **electrostatic force**. This force comes into play even when the bodies are not in contact. The electrostatic force, therefore, is another example of a non-contact force. You will learn more about electric charges in Chapter 15.

Gravitational Force

You know that a coin or a pen falls to the ground when it slips off your hand. Leaves and fruits also fall to the ground when they get detached from the plant. Have you ever wondered why it is so?

When the coin is held in your hand it is at rest. As soon as it is released, it begins to move downwards. It is clear that the state of motion of the coin undergoes a change. Can this happen without a force acting on it? Which is this force?

Objects or things fall towards the earth because it pulls them. This force is called the **force of gravity**, or just **gravity**. This is an attractive force. The force of gravity acts on all objects. The force of gravity acts on all of us all the time without our being aware of it. Water begins to flow towards the ground as soon as we open a tap. Water in rivers flows downward due to the force of gravity.

Gravity is not a property of the earth alone. In fact, every object in the universe, whether small or large, exerts a force on every other object. This force is known as the **gravitational force**.

11.8 Pressure

You have learnt in Class VII that strong winds during a storm or a cyclone can blow away even the roof-tops. You also learnt that winds and cyclones are caused by the differences in air pressure. Is there any relation between pressure and force? Let us find out.

Try to push a nail into a wooden plank by its head. Did you succeed? Try now to push the nail by the pointed end (Fig. 11.12). Could you do it this time?



Fig. 11.12 : Pushing a nail into a wooden plank

Try cutting vegetables with a blunt knife and then with a sharp knife. Which is easier?

Do you get the feeling that the area over which the force is applied (for example, the pointed end of the nail) plays a role in making these tasks easier?

The force acting on a unit area of a surface is called **pressure**.

$$\text{pressure} = \text{force} / \text{area on which it acts}$$

At this stage we consider only those forces which act perpendicular to the surface on which the pressure is to be computed.



I now understand why porters place a round piece of cloth on their heads, when they have to carry heavy loads (Fig. 11.13). By doing this they increase the area of contact of the load with their head. So, the pressure on their head is reduced and they find it easier to carry the load.



Fig. 11.13 : A porter carrying a heavy load

Note that the area is in the denominator in the above expression. So, the smaller the area, larger the pressure on a surface for the same force. The area of the pointed end of the nail is much smaller than that of its head. The same force, therefore, produces a pressure sufficient to push the pointed end of the nail into the wooden plank.

Can you explain now why shoulder bags are provided with broad straps and not thin strap? And, why the tools meant for cutting and piercing always have sharp edges?

Do liquids and gases also exert pressure? Does it also depend on the area on which the force acts? Let us find out.

11.9 Pressure Exerted by Liquids and Gases

Activity 11.8

Take a transparent glass tube or a plastic pipe. The length of the pipe/tube should be about 25 cm and its diameter should be 5-7.5 cm. Also take a piece of thin sheet of a good quality rubber, say, a rubber balloon. Stretch the rubber sheet tightly over one end of the pipe. Hold the pipe at the middle, keeping it in a vertical position (Fig. 11.14). Ask one of your friends to pour some water in the pipe. Does the rubber sheet bulge out? Note also the height of the water column in the pipe. Pour some more water. Observe again the bulge in the rubber sheet and the height of the water column in the pipe. Repeat

this process a few more times. Can you see any relation between the amount of the bulge in the rubber sheet and the height of the water column in the pipe?

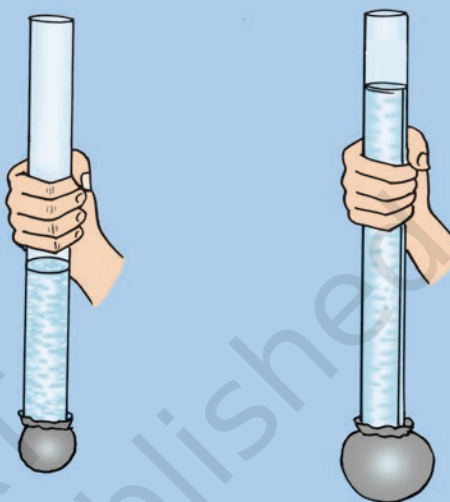

Fig.11.14 : Pressure exerted by water at the bottom of the container depends on the height of its column

Activity 11.9

Take a plastic bottle. You can take a discarded water or soft drink bottle. Fix a cylindrical glass tube, a few cm long near its bottom as shown in Fig. 11.15. You can do so by slightly heating one end of the glass tube and then quickly inserting it near the bottom of the bottle. Make sure that the water does not leak from the joint. If there is any leakage, seal it with molten wax. Cover the mouth of the glass tube with a thin rubber sheet as you did in Activity 11.8. Now fill the bottle upto half with water. What do you observe? Why does the rubber

sheet fixed to the glass tube bulge this time? Pour some more water in the bottle. Is there any change in the bulge of the rubber sheet?



Fig.11.15: A liquid exerts pressure on the walls of the container

Note that the rubber sheet has been fixed on the side of the container and not at the bottom. Does the bulging of the rubber sheet in this case indicate that water exerts pressure on the sides of the container as well? Let us investigate further.

Activity 11.10

Take an empty plastic bottle or a cylindrical container. You can take a used tin can or a used plastic bottle. Drill four holes all around near the bottom of the bottle. Make sure that the holes are at the same height from the bottom (Fig. 11.16). Now fill the bottle with water. What do you observe?

Do the different streams of water coming out of the holes fall at the same distance from the bottle? What does this indicate?



Fig. 11.16: Liquids exert equal pressure at the same depth

Can you now say that **liquids exert pressure on the walls of the container**?

Do gases also exert pressure? Do they also exert pressure on the walls of their containers? Let us find out.



I have seen fountains of water coming out of the leaking joints or holes in pipes supplying water. Is it not due to the pressure exerted by water on the walls of the pipes?

When you inflate a balloon, why do you have to close its mouth? What happens when you open the mouth of an inflated balloon? Suppose you have a balloon which has holes. Would you

be able to inflate it? If not, why? Can we say that air exerts pressure in all directions?

Do you recall what happens to the air in the bicycle tube when it has a puncture? Do these observations suggest that air exerts pressure on the inner walls of an inflated balloon or a tube? So, we find that **gases, too, exert pressure on the walls of their container.**

11.10 Atmospheric Pressure

You know that there is air all around us. This envelop of air is known as the **atmosphere**. The atmospheric air extends up to many kilometres above the surface of the earth. The pressure exerted by this air is known as **atmospheric pressure**. We know that pressure is force per unit area. If we imagine a unit area and a very long cylinder standing on it filled with air, then the force of gravity on the air in this cylinder is the atmospheric pressure (Fig. 11.17).



Fig. 11.17 : Atmospheric pressure is the force of gravity on air in a column of unit area

But, how large or small is the atmospheric pressure? Let us get an idea about its magnitude.

Activity 11.11

Take a good quality rubber sucker. It looks like a small rubber cup (Fig. 11.18). Press it hard on a smooth plane surface. Does it stick to the surface? Now try to pull it off the surface. Can you do it?



Fig.11.18 : A rubber sucker pressed on a surface

When you press the sucker, most of the air between its cup and the surface escapes out. The sucker sticks to the surface because the pressure of atmosphere acts on it. To pull the sucker off the surface, the applied force should be large enough to overcome the atmospheric pressure. This activity might give you an idea about the magnitude of atmospheric pressure. In fact, it would not be possible for any human being to pull the sucker off the

surface if there were no air at all between the sucker and the surface. Does it give you an idea how large the atmospheric pressure is?

If the area of my head were $15\text{ cm} \times 15\text{ cm}$, how much force air will exert on my head?



Fig. 11.19 : Pressure of atmosphere on your head

The force due to air in a column of the height of the atmosphere and area $15\text{ cm} \times 15\text{ cm}$ (Fig. 11.19) is nearly equal to the force of gravity on an object of mass 225 kg (2250N). The reason we are not crushed under this force of gravity is that the pressure inside our bodies is also equal to the atmospheric pressure and balances the pressure from outside.

Did you know?

Otto von Guericke, a German scientist of the 17th century, invented a pump to extract air out of a vessel. With the help of this pump, he demonstrated dramatically the force of the air pressure. He joined two hollow metallic hemispheres of 51 cm diameter each and pumped air out of them. Then he employed eight horses on each hemisphere to pull them apart (Fig. 11.20). So great is the force of air pressure that the hemispheres could not be pulled apart.

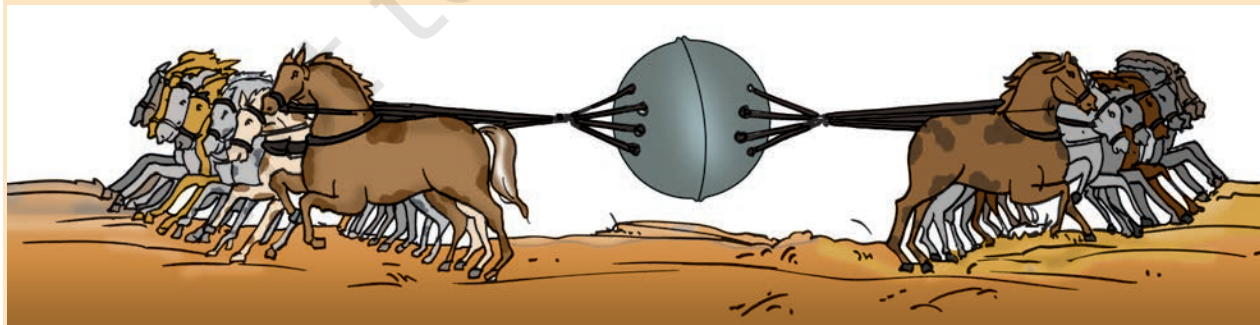

Fig. 11.20 : Horses pulling the hemispheres

KEYWORDS

ATMOSPHERIC
PRESSURE

CONTACT FORCE

ELECTROSTATIC
FORCE

FORCE

FRICTION

GRAVITATIONAL
FORCE

GRAVITY

MAGNETIC FORCE

MUSCULAR FORCE

NON-CONTACT
FORCE

PRESSURE

PULL

PUSH

WHAT YOU HAVE LEARNT

- Force could be a push or a pull.
- A force arises due to the interaction between two objects.
- Force has magnitude as well as direction.
- A change in the speed of an object or the direction of its motion or both implies a change in its state of motion.
- Force acting on an object may cause a change in its state of motion or a change in its shape.
- A force can act on an object with or without being in contact with it.
- Force per unit area is called pressure.
- Liquids and gases exert pressure on the walls of their containers.
- The pressure exerted by air around us is known as atmospheric pressure.

Exercises

1. Give two examples each of situations in which you push or pull to change the state of motion of objects.
2. Give two examples of situations in which applied force causes a change in the shape of an object.
3. Fill in the blanks in the following statements.
 - (a) To draw water from a well we have to _____ at the rope.
 - (b) A charged body _____ an uncharged body towards it.
 - (c) To move a loaded trolley we have to _____ it.
 - (d) The north pole of a magnet _____ the north pole of another magnet.

4. An archer stretches her bow while taking aim at the target. She then releases the arrow, which begins to move towards the target. Based on this information fill up the gaps in the following statements using the following terms.

muscular, contact, non-contact, gravity, friction, shape, attraction

- (a) To stretch the bow, the archer applies a force that causes a change in its _____.
- (b) The force applied by the archer to stretch the bow is an example of _____ force.
- (c) The type of force responsible for a change in the state of motion of the arrow is an example of a _____ force.
- (d) While the arrow moves towards its target, the forces acting on it are due to _____ and that due to _____ of air.
5. In the following situations identify the agent exerting the force and the object on which it acts. State the effect of the force in each case.
- (a) Squeezing a piece of lemon between the fingers to extract its juice.
- (b) Taking out paste from a toothpaste tube.
- (c) A load suspended from a spring while its other end is on a hook fixed to a wall.
- (d) An athlete making a high jump to clear the bar at a certain height.
6. A blacksmith hammers a hot piece of iron while making a tool. How does the force due to hammering affect the piece of iron?
7. An inflated balloon was pressed against a wall after it has been rubbed with a piece of synthetic cloth. It was found that the balloon sticks to the wall. What force might be responsible for the attraction between the balloon and the wall?
8. Name the forces acting on a plastic bucket containing water held above ground level in your hand. Discuss why the forces acting on the bucket do not bring a change in its state of motion.
9. A rocket has been fired upwards to launch a satellite in its orbit. Name the two forces acting on the rocket immediately after leaving the launching pad.
10. When we press the bulb of a dropper with its nozzle kept in water, air in the dropper is seen to escape in the form of bubbles. Once we release the pressure on the bulb, water gets filled in the dropper. The rise of water in the dropper is due to
- (a) pressure of water.
- (b) gravity of the earth.
- (c) shape of rubber bulb.
- (d) atmospheric pressure.

Extended Learning — Activities and Projects

1. Make a 50 cm × 50 cm bed of dry sand about 10 cm in thickness. Make sure that its top surface is levelled. Take a wooden or a plastic stool. Cut two strips of graph paper each with a width of 1 cm. Paste them vertically on any leg of the stool - one at the bottom and the other from the top. Now gently put the stool on the sand bed with its legs resting on the sand. Increase the size of sand bed if required. Now put a load, say a school bag full of books, on the seat of the stool. Mark the level of sand on the graph strip. This would give you the depth, if any, to which the legs of stool sink in sand. Next, turn the stool upside down so that now it rests on its seat on the sand bed. Note the depth to which the stool sinks now. Next, put the same load on the stool and note the depth to which it sinks in the sand. Compare the pressure exerted by the stool in the two situations.
2. Take a tumbler and fill it with water. Cover the mouth of the tumbler with a thick card similar to that of a postcard. Hold the tumbler with one hand while keeping the card pressed to its mouth with your other hand. Turn the tumbler upside down while keeping the card pressed to its mouth. Make sure that the tumbler is held vertical. Gently remove the hand pressing the card. What do you observe? Does the card get detached allowing the water to spill? With a little practice you will find that the card continues to hold water in the tumbler even after it is not supported by your hand. Also try this activity by using a piece of cloth to hold the tumbler in an upside down position (Fig. 11.21).



Fig. 11.21

3. Take 4-5 plastic bottles of different shapes and sizes. Join them together with small pieces of glass or rubber tube as shown in Fig. 11.22. Keep this arrangement on a level surface. Now pour water in any one of the bottles. Note whether the bottle in which water is poured gets filled first or all the bottles get filled up simultaneously. Note the level of water in all the bottles from time to time. Try to explain your observations.

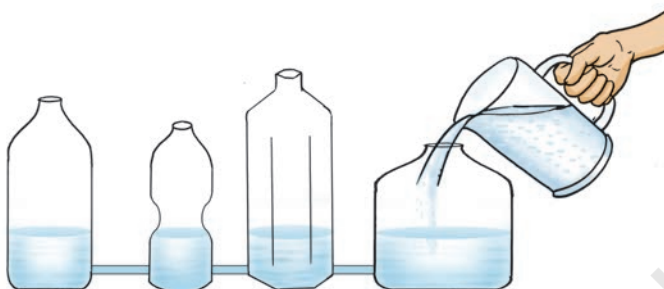

Fig. 11.22

CHAPTER 12 FRICTION



0854CH12

You might have seen a driver of a car or a truck slowing down the vehicle at a traffic signal. You, too, slow down your bicycle whenever needed by applying brakes. Have you ever thought why a vehicle slows down when brakes are applied? Not only vehicles, any object, moving over the surface of another object slows down when no external force is applied on it. Finally it stops. Have you not seen a moving ball on the ground stopping after some time? Why do we slip when we step on a banana peel (Fig. 12.1)? Why is it difficult to walk on a smooth and wet floor?



Fig. 12.1 : A boy falls down when he steps on a banana peel

You will find the answers to such questions in this chapter.

12.1 Force of Friction

Activity 12.1

Gently push a book on a table [Fig. 12.2(a)]. You observe that it stops after moving for some distance. Repeat this activity pushing the book from the opposite direction [Fig. 12.2, (b)]. Does the book stop this time, too? Can you think of an explanation? Can we say that a force must be acting on the book opposing its motion? This force is called the force of friction.

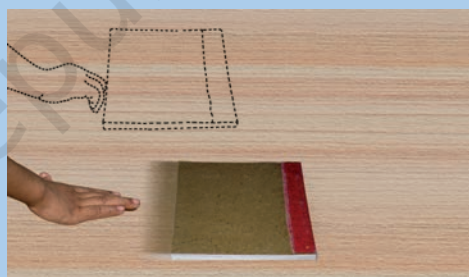

(a)

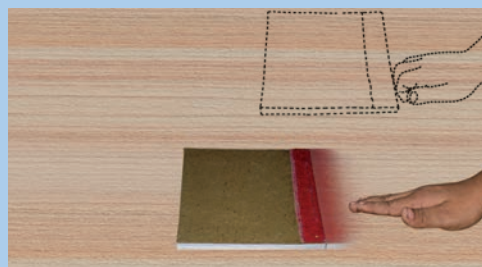

(b)

Fig. 12.2 (a), (b) : Friction opposes relative motion between the surfaces of the book and the table

You saw that if you apply the force along the left, friction acts along the right. If you apply the force along the right, the friction acts along the left direction. In both cases the force opposes the motion of the book. The force of friction always opposes the applied force.

In the above activity, the force of friction acts between the surface of the book and the surface of the table.

Is the friction the same for all the surfaces? Does it depend on the smoothness of the surfaces? Let us find out.

12.2 Factors affecting Friction

Activity 12.2

Tie a string around a brick. Pull the brick by a spring balance (Fig. 12.3). You need to apply some force. Note down the reading on the spring balance when the brick just begins to move. It gives you a measure of the force of friction between the surface of the brick and the floor.

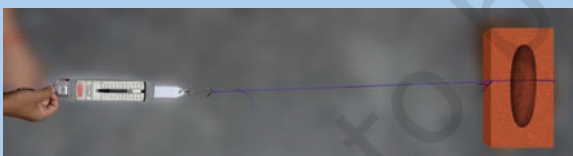

Fig. 12.3 : A brick is being pulled by spring balance

Now wrap a piece of polythene around the brick and repeat the activity. Do you observe any difference in the readings of the spring balance in the above two cases? What might be the reason

for this difference? Repeat this activity by wrapping a piece of jute bag around the brick. What do you observe?

Spring Balance

Spring balance is a device used for measuring the force acting on an object. It consists of a coiled spring which gets stretched when a force is applied to it. Stretching of the spring is measured by a pointer moving on a graduated scale. The reading on the scale gives the magnitude of the force.



Activity 12.3

Make an inclined plane on a smooth floor, or on a table. You may use a wooden board supported by bricks, or books. [Fig. 12.4 (a)]. Put a mark with a pen at any point A on the inclined plane. Now let a pencil cell move down from this point. How far does it move on the table before coming to rest? Note down the distance. Now spread a piece of cloth

over the table. Make sure that there are no wrinkles in the cloth. Try the activity again [Fig. 12.4 (b)].



(a)



(b)

Fig. 12.4 : The pencil cell covers different distances on different surfaces

Repeat this activity by spreading a thin layer of sand over the table. Maintain the same slope throughout the activity.

In which case is the distance covered the minimum? Why is the distance covered by the pencil cell different every time. Try to reason why? Discuss the result.

Does the distance covered depend on the nature of the surface on which the cell moves?

Could the smoothness of the surface of the cell also affect the distance travelled by it?



I shall try the activity by wrapping a piece of sandpaper around the cell.

Friction is caused by the irregularities on the two surfaces in contact. Even those surfaces which appear very smooth have a large number of minute irregularities on them (Fig. 12.5). Irregularities on the two surfaces lock into one another. When we attempt to move any surface, we have to apply a force to overcome interlocking. On rough surfaces, there are a larger number of irregularities. So the force of friction is greater if a rough surface is involved.

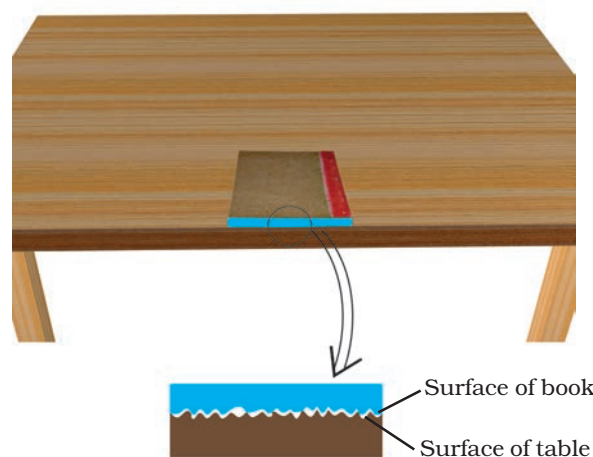

Fig. 12.5 : Surface irregularities

We see that the friction is caused by the interlocking of irregularities in the two surfaces. It is obvious that the force of friction will increase if the two surfaces are pressed harder. You can experience it by dragging a mat when nobody is sitting on it, and when a person is sitting on it.



Fig. 12.6 : You have to push on the box to keep it moving

Recall your experience when last time you moved a heavy box from one place to another (Fig. 12.6). If you have no such experience, get that experience now. What is easier — to move the box from rest, or to move it when it is already in motion?

The force required to overcome friction at the instant an object starts moving from rest is a measure of static friction. On the other hand, the force required to keep the object moving with the same speed is a measure of sliding friction.

When the box starts sliding, the contact points on its surface, do not get enough time to lock into the contact points on the floor. So, the sliding friction is slightly smaller than the static

friction and you find it somewhat easier to move the box already in motion than to get it started.

12.3 Friction : A Necessary Evil

Recall now some of your experiences. Is it easier to hold a *kulhar* (earthen pot) or a glass tumbler? Suppose the outer surface of the tumbler is greasy, or has a thin layer of cooking oil on it; would it become easier or more difficult to hold it? Just think : would it be possible to hold the glass at all if there is no friction?

Recall also how difficult it is to move on a wet muddy track, or wet marble floor. Can you imagine being able to walk at all if there were no friction?

You could not write with pen or pencil if there were no friction. When your teacher is writing with chalk on the blackboard, its rough surface rubs off some chalk particles which stick to



Fig. 12.7 : A nail is fixed in the wall due to friction

the black board. Could it happen if there were no friction between the chalk and the board?

If an object started moving, it would never stop if there were no friction. Had there been no friction between the tyres of the automobiles and the road, they could not be started or stopped or turned to change the direction of motion. You could not fix a nail on the wall (Fig. 12.7) or tie a knot. Without friction no building could be constructed.



Fig. 12.8 : Soles of shoes wear out due to friction

On the other hand, friction is an evil, too. It wears out the materials whether they are screws, ball bearings or soles of shoes (Fig. 12.8). You must have seen worn-out steps of foot over-bridges at railway stations.

Friction can also produce heat. Vigorously rub your palms together for a few minutes (Fig. 12.9). How do you feel? When you strike a matchstick against the rough surface, it catches fire (Fig. 12.10).

You might have observed that the jar of a mixer becomes hot when it is run



Fig. 12.9 : Rubbing of your palms makes you feel warm

for a few minutes. You can cite various other examples in which friction

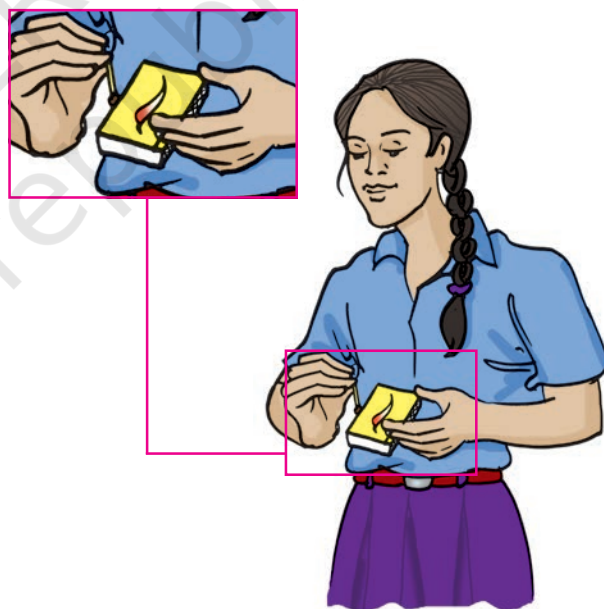

Fig. 12.10 : Stricking a matchstick produces fire by friction

produces heat. In fact, when a machine is operated, heat generated causes much wastage of energy. We shall discuss the ways of minimising friction in the following section.

12.4 Increasing and Reducing Friction

As you have seen in the previous section, friction is desirable in some situations.

Have you ever thought why the sole of your shoe is grooved [Fig. 12.11 (a)]? It is done to provide the shoes better grip on the floor, so that you can move safely. Similarly, the treaded tyres of cars, trucks and bulldozers provide better grip with the ground.



Fig. 12.11 : (a) Soles of shoes and (b) tyres are treaded to increase friction

We deliberately increase friction by using brake pads in the brake system of bicycles and automobiles. When you are riding a bicycle, the brake pads do not touch the wheels. But when you press the brake lever, these pads arrest the motion of the rim due to friction. The wheel stops moving. You might have seen that *kabaddi* players rub their hands with soil for a better grip of their opponents. Gymnasts apply some coarse substance on their hands to increase friction for better grip.

In some situations, however, friction is undesirable and we would want to minimise it.

Why do you sprinkle fine powder on the carrom board (Fig. 12.12)? You might have noticed that when a few drops of oil are poured on the hinges of a door, the door moves smoothly. A bicycle and a motor mechanic uses grease between the moving parts of these machines. In all the above cases, we want to reduce



Fig. 12.12 : Powder is sprinkled on the carrom board to reduce friction

friction in order to increase efficiency. When oil, grease or graphite is applied between the moving part of a machine, a thin layer is formed there and moving surfaces do not directly rub against each other (Fig. 12.13). Interlocking of irregularities is avoided to a great extent. Movement becomes smooth. The substances which reduce friction are called **lubricants**. In some machines, it may not be advisable to use oil as lubricant. An air cushion between the moving parts is used to reduce friction.

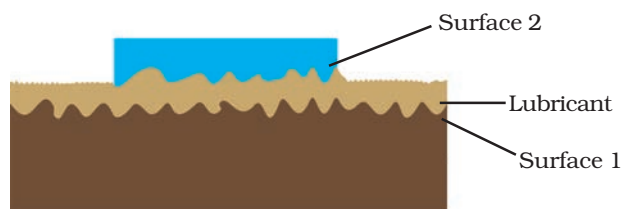

Fig. 12.13 : Action of lubricant



Can we reduce friction to zero by polishing surfaces or using large amount of lubricants?



Friction can never be entirely eliminated. No surface is perfectly smooth. Some irregularities are always there.

12.5 Wheels Reduce Friction

You must have seen attaches and other pieces of luggage fitted with rollers. Even a child can pull such pieces of luggage (Fig. 12.14). Why is it so? Let us find out.



Fig. 12.14 : Rolling reduces friction

Activity 12.4

Take a few pencils which are cylindrical in shape. Place them parallel to each other on a table. Place a thick book over it (Fig. 12.15). Now push the book. You observe the pencils rolling as the book moves. Do you feel it easier to move the book in this way than to slide it? Do you think that resistance to the motion of the book has been reduced? Have you seen heavy machinery being moved by placing logs under it?



Fig. 12.15 : Motion of the book on rollers

When one body rolls over the surface of another body, the resistance to its motion is called **rolling friction**. Rolling reduces friction. It is always easier to roll than to slide a body over another. That is the reason it is convenient to pull luggage fitted with rollers. Can you now understand why the wheel is said to be one of the greatest inventions of mankind?

Since the rolling friction is smaller than the **sliding friction**, sliding is replaced in most machines by rolling by the use of ball bearings. Common examples are the use of ball bearings between hubs and the axles of ceiling fans and bicycles (Fig. 12.16).

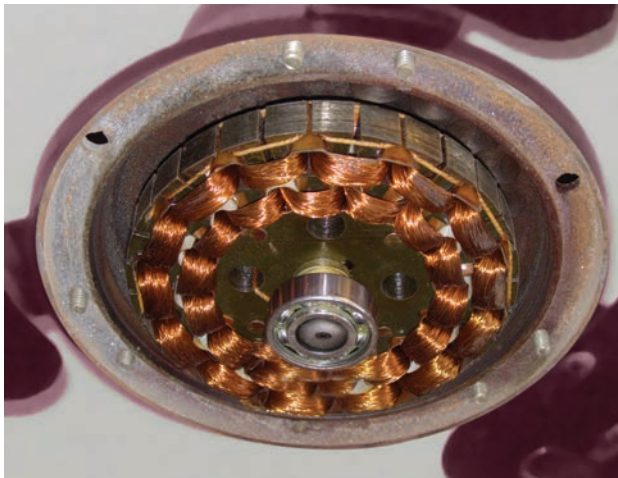

is **fluids**. So we can say that fluids exert force of friction on objects in motion through them.

The frictional force exerted by fluids is also called **drag**.

The frictional force on an object in a fluid depends on its speed with respect to the fluid. The frictional force also depends on the shape of the object and the nature of the fluid.

It is obvious that when objects move through fluids, they have to overcome friction acting on them. In this process they lose energy. Efforts are, therefore, made to minimise friction. So, objects are given special shapes. Where do you think scientists get hints for these special shapes? From nature, of course. Birds and fishes have to move about in fluids all the time. Their bodies must have evolved to shapes which would make them lose less energy in overcoming friction. You read about these shapes in Class VI. Look carefully at the shape of an aeroplane (Fig. 12.17). Do you find any similarity in its shape and that of a bird? In fact, all vehicles are designed to have shapes which reduce fluid friction.



Fig. 12.16 : Ball bearings reduce friction

12.6 Fluid Friction

You know that air is very light and thin. Yet it exerts frictional force on objects moving through it. Similarly, water and other liquids exert force of friction when objects move through them. In science, the common name of gases and liquids

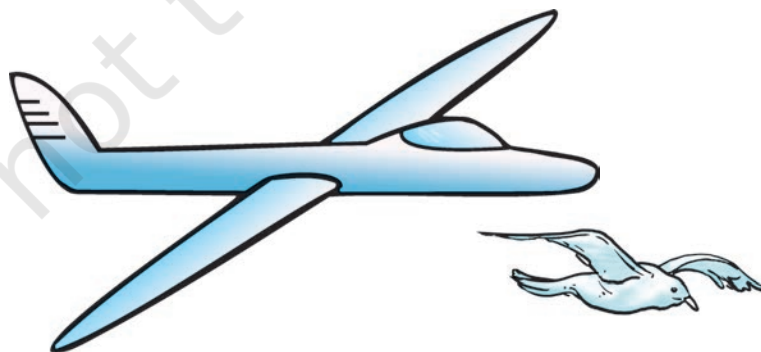

Fig. 12.17 : Similarity in shapes of an aeroplane and a bird

KEYWORDS

BALL BEARING

DRAG

FLUID FRICTION

FRICTION

INTERLOCKING

LUBRICANTS

ROLLING FRICTION

SLIDING FRICTION

STATIC FRICTION

WHAT YOU HAVE LEARNT

- Friction opposes the relative motion between two surfaces in contact. It acts on both the surfaces.
- Friction depends on the nature of surfaces in contact.
- For a given pair of surfaces friction depends upon the state of smoothness of those surfaces.
- Friction depends on how hard the two surfaces press together.
- Static friction comes into play when we try to move an object at rest.
- Sliding friction comes into play when an object is sliding over another.
- Sliding friction is smaller than static friction.
- Friction is important for many of our activities.
- Friction can be increased by making a surface rough.
- The sole of the shoes and the tyres of the vehicle are treaded to increase friction.
- Friction is sometimes undesirable.
- Friction can be reduced by using lubricants.
- When one body rolls over another body, rolling friction comes into play. Rolling friction is smaller than sliding friction.
- In many machines, friction is reduced by using ball bearings.
- Fluid friction can be minimised by giving suitable shapes to bodies moving in fluids.

A riddle for you

*In some situations, I oppose the motion
in other situations, I facilitate the motion
but, I always oppose
the relative motion
between two moving surfaces.
Put some lubricant, and
I become small there.
Make the moving surfaces rough
I make the movement tough.
I may be—
static, sliding or rolling
but whenever two surfaces are in motion
I am always there,
Tell me who I am!*

Exercises

- Fill in the blanks.
 - Friction opposes the _____ between the surfaces in contact with each other.
 - Friction depends on the _____ of surfaces.
 - Friction produces _____.
 - Sprinkling of powder on the carrom board _____ friction.
 - Sliding friction is _____ than the static friction.
- Four children were asked to arrange forces due to rolling, static and sliding frictions in a **decreasing order**. Their arrangements are given below. Choose the correct arrangement.
 - rolling, static, sliding
 - rolling, sliding, static
 - static, sliding, rolling
 - sliding, static, rolling
- Alida runs her toy car on dry marble floor, wet marble floor, newspaper and towel spread on the floor. The force of friction acting on the car on different surfaces in **increasing order** will be
 - wet marble floor, dry marble floor, newspaper and towel.
 - newspaper, towel, dry marble floor, wet marble floor.
 - towel, newspaper, dry marble floor, wet marble floor.
 - wet marble floor, dry marble floor, towel, newspaper
- Suppose your writing desk is tilted a little. A book kept on it starts sliding down. Show the direction of frictional force acting on it.
- You spill a bucket of soapy water on a marble floor accidentally. Would it make it easier or more difficult for you to walk on the floor? Why?
- Explain why sportsmen use shoes with spikes.
- Iqbal has to push a lighter box and Seema has to push a similar heavier box on the same floor. Who will have to apply a larger force and why?
- Explain why sliding friction is less than static friction.
- Give examples to show that friction is both a friend and a foe.
- Explain why objects moving in fluids must have special shapes.

Extended Learning — Activities and Projects

1. What role does friction play in the sport of your choice? Collect some pictures of that sport in action where friction is either supporting it or opposing it. Display these pictures with proper captions on the bulletin board of your classroom.
2. Imagine that friction suddenly vanishes. How would life be affected. List ten such situations.
3. Visit a shop which sells sports shoes. Observe the soles of shoes meant for various sports. Describe your observations.
4. A toy to play with:

Take an empty match box. Take out its tray. Cut a used refill of a ball pen of the same width as the tray as shown in the figure below. Fix the refill with two pins on the top of the tray as shown in Fig. 12.18. Make two holes on the opposite sides of the tray. Make sure that the holes are large enough to allow a thread to pass through them easily. Take a thread about a metre long and pass it through the holes as shown. Fix beads at the two ends of the thread so that it does not come out. Insert the tray in the outer cover of the matchbox.

Suspend the match box by the thread. Leave the thread loose. The match box will start falling down due to gravity. Tighten the thread now and observe what happens.

Explain your observation. Can you relate it to friction?

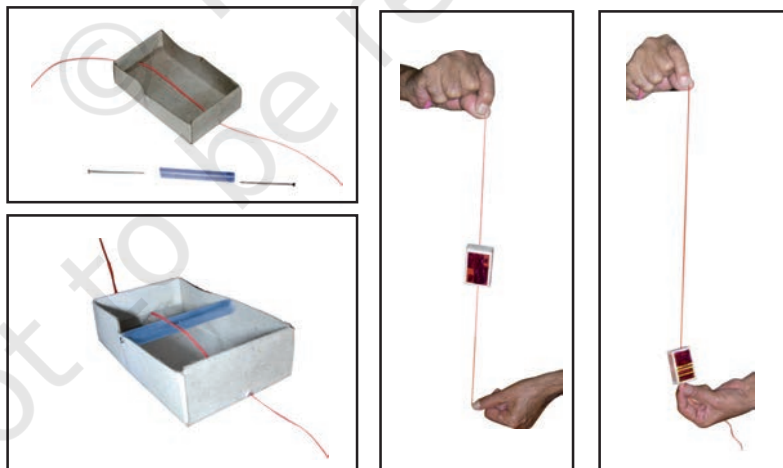

Fig. 12.18

You can read more on the related topic on the following websites :

- <http://www.school-for-champions.com/science/friction.htm>
- <http://hyperphysics.phy-astr.gsu.edu/hbase/frict2.html>

CHAPTER 13 SOUND



0854CH13

How do you come to know that a 'period' is over in your school? You come to know easily that someone is at your door when he knocks or you hear the sound of the doorbell. Most of the time you can make out that someone is approaching you by just hearing the foot steps.

You might have played a game called hide and seek. In this game a person is blind-folded and has to catch the remaining players. How is the blind-folded person able to guess which player is closest to her?

Sound plays an important role in our lives. It helps us to communicate with one another. We hear a variety of sounds in our surroundings.

Make a list of sounds you hear in your surroundings.

In the music room of your school you hear the sounds produced by musical instruments like flute, *tabla*, harmonium, etc. (Fig 13.1).

How is sound produced? How does it travel from one place to another? How do we hear sound? Why are some sounds louder than others? We shall discuss such questions in this chapter.



Fig. 13.1 : Some musical instruments

13.1 Sound is Produced by a Vibrating Body

Touch the school bell when not in use. What do you feel? Again touch it when producing sound. Can you feel it vibrating?

Activity 13.1

Take a metal plate (or a pan). Hang it at a convenient place in such a way that it does not touch any wall. Now strike it with a stick (Fig. 13.2). Do you hear a sound? Touch the plate or pan gently with your finger. Do you feel the vibrations?



Fig. 13.2 : Striking a pan

Again strike the plate with the stick and hold it tightly with your hands immediately after striking. Do you still hear the sound? Touch the plate after it stops producing sound. Can you feel the vibrations now?

Activity 13.2

Take a rubber band. Put it around the longer side of a pencil box (Fig. 13.3). Insert two pencils between the box and the stretched rubber. Now, pluck the rubber band somewhere in the middle. Do you hear any sound? Does the band vibrate?



Fig. 13.3 : Plucking the rubber band

As you learnt in Class VII the to and fro or back and forth motion of an object is called **vibration**. When a tightly stretched band is plucked, it vibrates and produces sound. When it stops vibrating, it does not produce any sound.

Activity 13.3

Take a metal dish. Pour water in it. Strike it at its edge with a spoon (Fig. 13.4). Do you hear a sound? Again strike the dish and then touch it. Can you feel the dish vibrating? Strike the dish again. Look at the surface of water. Do you see any waves there? Now hold the dish. What change do you observe on the surface of water? Can you explain the change? Is there a hint to connect sound with the vibrations of a body?



Fig. 13.4 : Vibrating dish produces waves in water

We see that a vibrating object produces sound. In some cases, the vibrations are easily visible to us. But in most cases, their amplitude is so small that we cannot see them. However, we can feel them.

Activity 13.4

Take a hollow coconut shell and make a musical instrument *ektara*. You can also make it with the help of an earthen pot (Fig. 13.5). Play this instrument and identify its vibrating part.

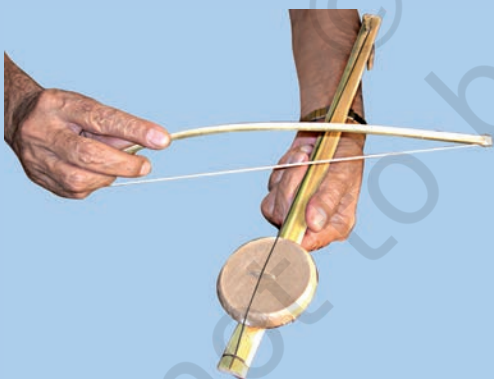

Fig. 13.5 : Ektara

Make a list of familiar musical instruments and identify their vibrating parts. A few examples are given in Table 13.1. Complete rest of the Table.

Table 13.1 : Musical Instruments and their Vibrating Parts

S.No.	Musical Instrument	Vibrating Part Producing Sound
1.	<i>Veena</i>	Stretched string
2.	<i>Tabla</i>	Stretched membrane
3.		
4.		
5.		
6.		
7.		

Many of you might have seen the *manjira* (cymbals), the *ghatam*, and the *noot* (mudpots) and the *kartal*. These musical instruments are commonly used in many parts of our country. These instruments are simply beaten or struck (Fig. 13.6). Can you name a few other musical instruments of this type?

You too can make a musical instrument.

Ghatam



Manjira

Fig. 13.6 : A few more musical instruments

Activity 13.5

Take 6-8 bowls or tumblers. Fill them with water up to different levels, increasing gradually from one end to the other. Now take a pencil and strike the bowls gently. Strike all of them in succession. You will hear pleasant sounds. This is your *jaltrang* (Fig. 13.7).



Fig. 13.7 : Jaltrang

When we pluck the string of an instrument, like the sitar, the sound that we hear is not only that of the string. The whole instrument is forced to vibrate, and it is the sound of the vibration of the instrument that we hear. Similarly, when we strike the membrane of a *mridangam*, the sound that we hear is not only that of the membrane but of the whole body of the instrument.



When we speak, does any part of our body vibrate?

13.2 Sound Produced by Humans

Speak loudly for a while or sing a song, or buzz like a bee. Put your hand on your throat as shown in Fig. 13.8. Do you feel any vibrations?

In humans, the sound is produced by the **voice box** or the **larynx**. Put your fingers on the throat and find a hard bump that seems to move when you swallow. This part of the body is known as the voice box. It is at the upper end of the **windpipe**. Two **vocal cords**, are stretched across the voice box or larynx in such a way that it leaves a narrow slit between them for the passage of air (Fig. 13.8).

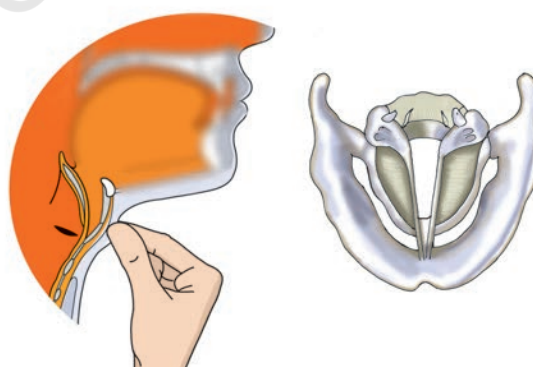

Fig.13.8 : Voice box in humans

When the lungs force air through the slit, the vocal cords vibrate, producing sound. Muscles attached to the vocal cords can make the cords tight or loose. When the vocal cords are tight and thin, the type or quality of voice is different

from that when they are loose and thick. Let us see how the vocal cords function.

Activity 13.6

Take two rubber strips of the same size. Place these two pieces one above the other and stretch them tight. Now blow air through the gap between them [Fig. 13.9(a)]. As the air blows through the stretched rubber strips, a sound is produced. You can also take a piece of paper with a narrow slit and hold it between your fingers as shown in Fig. 13.9 (b). Now blow through the slit and listen to the sound. Our vocal cords produce sound in a similar manner.

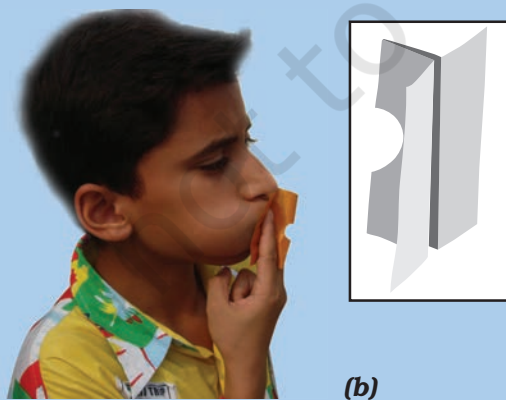
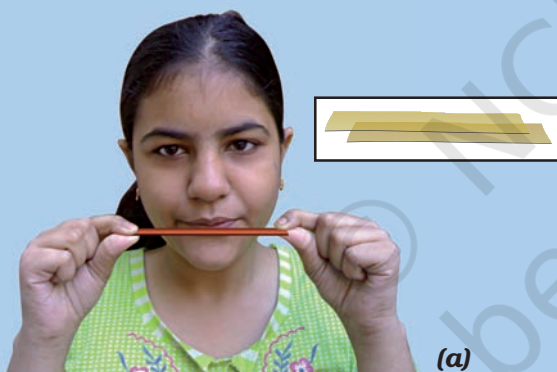

Fig. 13.9 (a), (b) : Working of vocal cords

The vocal cords in men are about 20 mm long. In women these are about 15mm long. Children have very short vocal cords. This is the reason why the voices of men, women and children are different.

13.3 Sound Needs a Medium for Propagation

When you call up your friend who is standing at a distance, your friend is able to hear your voice. How does the sound propagate or travel to her?

Activity 13.7

Take a metal or glass tumbler. Make sure that it is dry. Place a cell phone in it. (*Remember that the cell phone must not be kept in water.*) Ask your friend to give a ring on this cell phone from another cell phone. Listen to the ring carefully.

Now, surround the rim of the tumbler with your hands (Fig. 13.10). Put your mouth on the



Fig. 13.10 : Sound needs a medium to travel

opening between your hands. Indicate to your friend to give a ring again. Listen to the ring while sucking air from the tumbler.

Does the sound become fainter as you suck air?

Remove the tumbler from your mouth. Does the sound become loud again?

Can you think of an explanation? Is it possible that the decreasing amount of air in the tumbler had something to do with decreasing **loudness** of the ring?

Indeed, if you had been able to suck all the air in the tumbler, you will not listen any sound. Actually, sound needs a medium to travel. When air has been removed completely from a vessel, it is said that there is a **vacuum** in the vessel. The sound cannot travel through a vacuum.

Does sound travel in liquids? Let us find out.

Activity 13.8

Take a bucket or a bathtub. Fill it with clean water. Take a small bell in one hand. Shake this bell inside the water to produce sound. Make sure that the bell does not touch the body of the bucket or the tub.



Fig. 13.11 : Sound travelling through water

Place your ear gently on the water surface (Fig. 13.11). (*Be careful: the water should not enter in your ear.*) Can you hear the sound of the bell? Does it indicate that sound can travel through liquids?



Oh ! That is how whales and dolphins might be communicating under water.

Let us find out if sound can travel through solids also.

Activity 13.9

Take a metre scale or a long metal rod and hold its one end to your ear. Ask your friend to gently scratch or tap at the other end of the scale (Fig. 13.12).



Fig. 13.12 : Sound travelling through a metre scale

Can you hear the sound of the scratching? Ask your friends around you if they were able to hear the same sound?

You can also perform the above activity by placing your ear at one end of a long wooden or metallic table and asking your friend to gently scratch the other end of the table (Fig. 13.13).



Fig. 13.13 : Sound can travel through solids

We find that sound can travel through wood or metal. In fact, sound can travel through any solid. You can perform interesting activities to show that sound can also travel through strings. Have you ever made a toy telephone (Fig. 13.14). Can you say that sound can travel through strings?

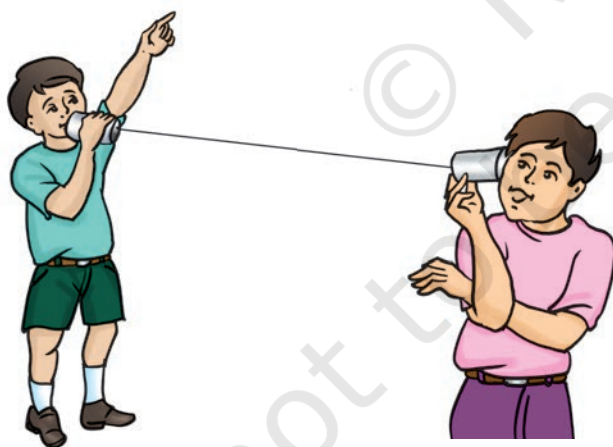

Fig. 13.14 : A toy telephone

We have learnt so far that vibrating objects produce sound and it is carried in all directions in a medium. The medium could be a gas, a liquid or a solid. How do we hear it?

13.4 We Hear Sound through Our Ears

The shape of the outer part of the ear is like a funnel. When sound enters it, it travels down a canal at the end of which there is a thin stretched membrane. It is called the **eardrum**. It performs an important function. To understand what the eardrum does, let us build a tin-can model of the eardrum.

Activity 13.10

Take a plastic or tin-can. Cut its ends. Stretch a piece of rubber balloon across one end of the can and fasten it with a rubber band. Put four or five grains of dry cereal on the stretched rubber. Now ask your friend to speak “Hurrey, Hurrey” from the open end (Fig.13.15). Observe what happens to the grain. Why do the grains jump up and down?



Fig. 13.15 : Understanding action of an eardrum

The eardrum is like a stretched rubber sheet. Sound vibrations make the eardrum vibrate (Fig. 13.16). The eardrum sends vibrations to the inner ear. From there, the signal goes to the brain. That is how we hear.

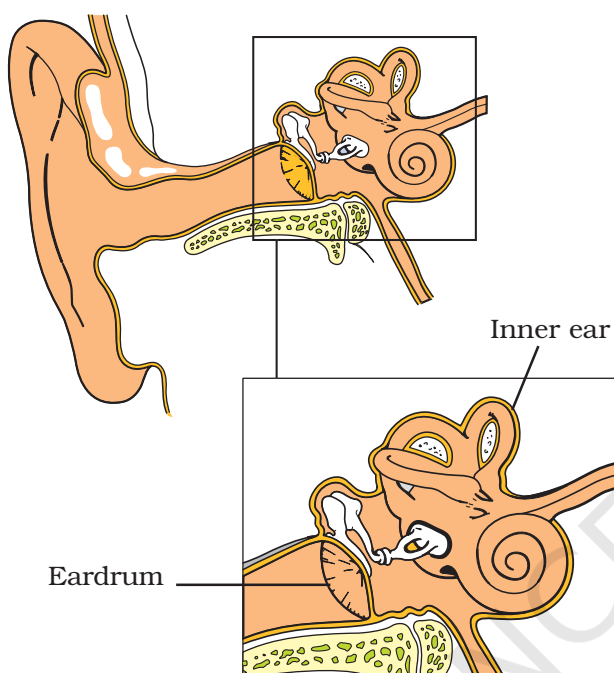

Fig. 13.16 : Human ear



We must NEVER put a sharp, pointed or hard thing into our ear. It can damage the eardrum. The damaged eardrum can impair hearing.

13.5 Amplitude, Time Period and Frequency of a Vibration

We have learnt that the to and fro motion of an object is known as vibration. This motion is also called **oscillatory motion**.

You have already learnt in earlier classes about the oscillatory motion and its time period.

The number of **oscillations** per second is called the **frequency** of oscillation. Frequency is expressed in **hertz**. Its symbol is Hz. A frequency of 1 Hz is one oscillation per second. If an object oscillates 20 times in one second, what would be its frequency?

You can recognise many familiar sounds without seeing the objects producing them. How is it possible? These sounds must be different to enable you to recognise them. Have you ever thought what factors make them different? **Amplitude** and frequency are two important properties of any sound. Can we differentiate sounds on the basis of their amplitudes and frequencies?

Loudness and Pitch

Activity 13.11

Take a metallic tumbler and a tablespoon. Strike the tablespoon gently at the brim of the tumbler.

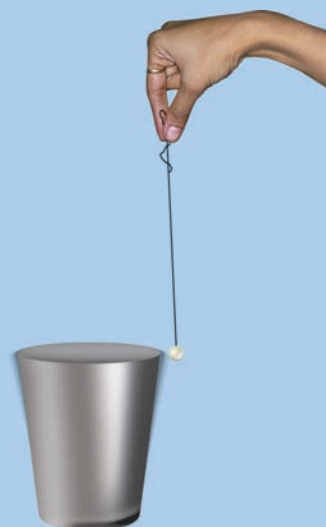

Fig. 13.17 : Thermocol ball touching the vibrating glass tumbler

Hear the sound produced. Now bang the spoon on the tumbler and hear the sound produced again. Is the sound louder when the tumbler is struck hard?

Now suspend a small thermocol ball touching the rim of the tumbler (Fig. 13.17). Vibrate the tumbler by striking it. See how far the ball is displaced. The displacement of the ball is a measure of the amplitude of vibration of the tumbler.

Now, strike the tumbler gently and then a little harder. Compare the amplitudes of vibrations of the tumbler in the two cases. In which case is the amplitude larger?

Loudness of sound is proportional to the square of the amplitude of the vibration producing the sound. For example, if the amplitude becomes twice, the loudness increases by a factor of 4. The loudness is expressed in a unit called decibel (dB). The following table gives some idea of the loudness of sound coming from various sources.

Normal breathing	10 dB
Soft whisper (at 5m)	30 dB
Normal conversation	60 dB
Busy traffic	70 dB
Average factory	80 dB

Above 80 dB the noise becomes physically painful.

The loudness of sound depends on its amplitude. When the amplitude of vibration is large, the sound produced is loud. When the amplitude is small, the sound produced is feeble.

Compare the sound of a baby with that of an adult. Is there any difference? Even if two sounds are equally loud, they differ in some way. Let us see how.

I wonder why my voice is different from that of my teacher.



The frequency determines the **shrillness** or **pitch** of a sound. If the frequency of vibration is higher we say that the sound is shrill and has a higher pitch. If the frequency of vibration is lower, we say that the sound has a lower pitch. For example, a drum vibrates with a low frequency. Therefore, it produces

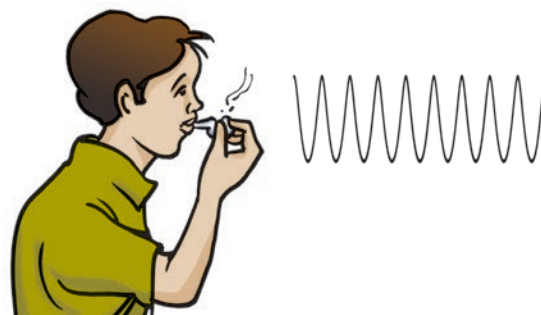
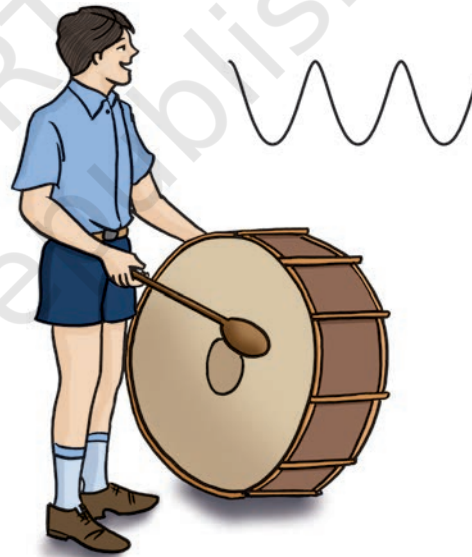

Fig. 13.18 : Frequency determines the pitch of a sound

a low-pitched sound. On the other hand, a whistle has a high frequency and therefore, produces a sound of higher pitch (Fig. 13.18). A bird makes a high-pitched sound whereas a lion makes a low-pitched roar. However, the roar of a lion is very loud while the sound of the bird is quite feeble.

Every day you hear the voices of children and adults. Do you find any difference in their voices? Can you say that the frequency of the voice of a child is higher than that of an adult? Usually the voice of a woman has a higher frequency than that of a man.

13.6 Audible and Inaudible Sounds

We know that we need a vibrating body for the production of sound. Can we hear the sound of all vibrating bodies?

The fact is that sounds of frequencies less than about 20 vibrations per second (20 Hz) cannot be detected by the human ear. Such sounds are called inaudible. On the higher side, sounds of frequencies higher than about 20,000 vibrations per second (20 kHz) are also not audible to the human ear. Thus, for human ear, the range of audible frequencies is roughly from 20 to 20,000 Hz.

Some animals can hear sounds of frequencies higher than 20,000 Hz. Dogs have this ability. The police use high frequency whistles which dogs can hear but humans cannot.

The ultrasound equipment, familiar to us for investigating and tracking many medical problems, works at frequencies higher than 20,000 Hz.

13.7 Noise and Music

We hear different types of sounds around us. Is the sound always pleasing? Does a sound sometimes cause discomfort to you? Some sounds are pleasant to the ear, whereas some are not.

Suppose construction work is going on in your neighbourhood. Are the sounds coming from the construction site pleasing? Do you enjoy the sounds produced by horns of buses and trucks? Such unpleasant sounds are called **noise**. In a classroom, if all the students speak together, what would the sound produced be called?

On the other hand you enjoy sounds from musical instruments. **Musical sound** is one which is pleasing to the ear. Sound produced by a harmonium is a musical sound. The string of a sitar also gives out a musical sound. But, if a musical sound becomes too loud, would it remain melodious?

13.8 Noise Pollution

You already know about air pollution. Presence of unwanted gases and particles in air is called air pollution. Similarly, presence of excessive or unwanted sounds in the environment is called noise pollution. Can you list some sources of noise pollution? Major causes of noise pollution are sounds of vehicles, explosions including bursting of crackers, machines, loudspeakers etc. What sources in the home may lead to noise? Television and transistor radio at high volumes, some kitchen appliances, desert coolers, air conditioners, all contribute to noise pollution.

What are the Harms of Noise Pollution?

Do you know that presence of excessive noise in the surroundings may cause many health related problems. Lack of sleep, hypertension (high blood-pressure), anxiety and many more health disorders may be caused by noise pollution. A person who is exposed to a loud sound continuously may get temporary or even permanent impairment of hearing.

Measures to Limit Noise Pollution

To control noise, we must control the sources of noise. How can this be achieved? For this, silencing devices

must be installed in air craft engines, transport vehicles, industrial machines and home appliances.

How can the noise pollution be controlled in a residential area?

All noisy operations must be conducted away from any residential area. Noise producing industries should be set up away from such areas. Use of automobile horns should be minimised. TV and music systems should be run at low volumes. Trees must be planted along the roads and around buildings to cut down on the sounds reaching the residents, thus reducing the harmful effects of noise pollution.

Hearing Impairment

Total hearing impairment, which is rare, is usually from birth itself. Partial disability is generally the result of a disease, injury or age. Children with impaired hearing need special care. By learning sign language, such children can communicate effectively. Because speech develops as the direct result of hearing, a child with a hearing loss may have defective speech also. Technological devices for the hearing-impaired have made it possible for such persons to improve their quality of life. Society can do much to improve the living environment for the hearing-impaired and help them live normal lives.

KEYWORDS

AMPLITUDE

EARDRUM

FREQUENCY

hertz (Hz)

LARYNX

LOUDNESS

NOISE

OSCILLATION

PITCH

TIME PERIOD

VIBRATION

VOICE BOX

WIND PIPE

WHAT YOU HAVE LEARNT

- Sound is produced by vibrating objects.
- In human beings, the vibration of the vocal cords produces sound.
- Sound travels through a medium (gas, liquid or solid). It cannot travel in vacuum.
- The eardrum senses the vibrations of sound. It sends the signals to the brain. This process is called hearing.
- The number of oscillations or vibrations per second is called the frequency of oscillation.
- The frequency is expressed in hertz (Hz)
- Larger the amplitude of vibration, the louder is the sound.
- Higher the frequency of vibration, the higher is the pitch, and shriller is the sound.
- Unpleasant sounds are called noise.
- Excessive or unwanted sounds lead to noise pollution. Noise pollution may pose health problems for human beings.
- Attempts should be made to minimise noise pollution.
- Plantation on the roadside and elsewhere can reduce noise pollution.

Exercises

1. Choose the correct answer.
Sound can travel through
 - (a) gases only
 - (b) solids only
 - (c) liquids only
 - (d) solids, liquids and gases.
2. Voice of which of the following is likely to have minimum frequency?
 - (a) Baby girl
 - (b) Baby boy
 - (c) A man
 - (d) A woman

3. In the following statements, tick 'T' against those which are true, and 'F' against those which are false.
 - (a) Sound cannot travel in vacuum. (T/F)
 - (b) The number of oscillations per second of a vibrating object is called its time period. (T/F)
 - (c) If the amplitude of vibration is large, sound is feeble. (T/F)
 - (d) For human ears, the audible range is 20 Hz to 20,000 Hz. (T/F)
 - (e) The lower the frequency of vibration, the higher is the pitch. (T/F)
 - (f) Unwanted or unpleasant sound is termed as music. (T/F)
 - (g) Noise pollution may cause partial hearing impairment. (T/F)
4. Fill in the blanks with suitable words.
 - (a) Time taken by an object to complete one oscillation is called _____.
 - (b) Loudness is determined by the _____ of vibration.
 - (c) The unit of frequency is _____.
 - (d) Unwanted sound is called _____.
 - (e) Shrillness of a sound is determined by the _____ of vibration.
5. A pendulum oscillates 40 times in 4 seconds. Find its time period and frequency.
6. The sound from a mosquito is produced when it vibrates its wings at an average rate of 500 vibrations per second. What is the time period of the vibration?
7. Identify the part which vibrates to produce sound in the following instruments.
 - (a) *Dholak* (b) *Sitar* (c) Flute
8. What is the difference between noise and music? Can music become noise sometimes?
9. List sources of noise pollution in your surroundings.
10. Explain in what way noise pollution is harmful to human.
11. Your parents are going to buy a house. They have been offered one on the roadside and another three lanes away from the roadside. Which house would you suggest your parents should buy? Explain your answer.
12. Sketch larynx and explain its function in your own words.
13. Lightning and thunder take place in the sky at the same time and at the same distance from us. Lightning is seen earlier and thunder is heard later. Can you explain why?

Extended Learning — Activities and Projects

1. Visit the music room of your school. You may also visit musicians in your locality. Make a list of musical instruments. Note down the parts of these instruments that vibrate to produce sound.
2. If you play a musical instrument, bring it to the class and demonstrate how you play it.
3. Prepare a list of famous Indian musicians and the instruments they play.
4. Take a long thread. Place your hands over your ears and get someone to place this thread round your head and hands. Ask her to make the thread taut and hold its ends in one hand. Now ask her to draw her finger and thumb tightly along the thread (Fig. 13.19). Can you hear a rolling sound like that of a thunder? Now repeat the activity while another friend stands near both of you. Can he hear any sound?

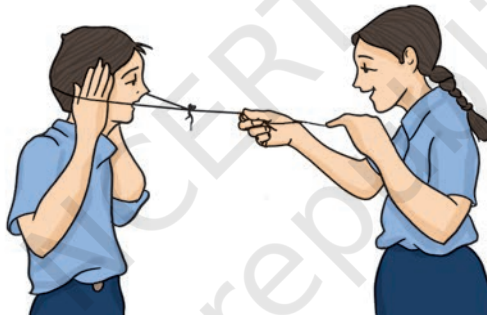

Fig. 13.19

5. Make two toy telephones. Use them as shown in Fig. 13.20. Make sure that the two strings are taut and touch each other. Let one of you speak. Can the remaining three persons hear? See how many more friends you can engage in this way. Explain your observations.

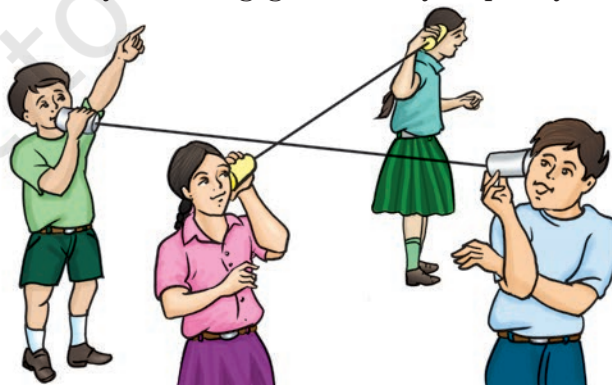

Fig. 13.20

6. Identify the sources of noise pollution in your locality. Discuss with your parents, friends and neighbours. Suggest how to control noise pollution. Prepare a brief report and present it in the class.

You can read more on the related topics on the following websites:

- www.physicsclassroom.com/Class/sound/soundtoc.html
- health.howstuffworks.com/hearing.htm

Did You Know?

Golconda fort, near Hyderabad, is one of the most magnificent forts in India. It is famous for many engineering and architectural marvels. One of the marvels is the water supply system. But, perhaps, more astonishing is a dome near the entrance to the fort. A hand-clap at a particular point under the dome reverberates and can be heard at the highest point of the fort, about a kilometre away. This was devised as a warning system. If a guard saw a suspicious movement outside the fort, he clapped at the particular point under the dome, and the army inside the fort was alerted to the danger of the approaching enemy.

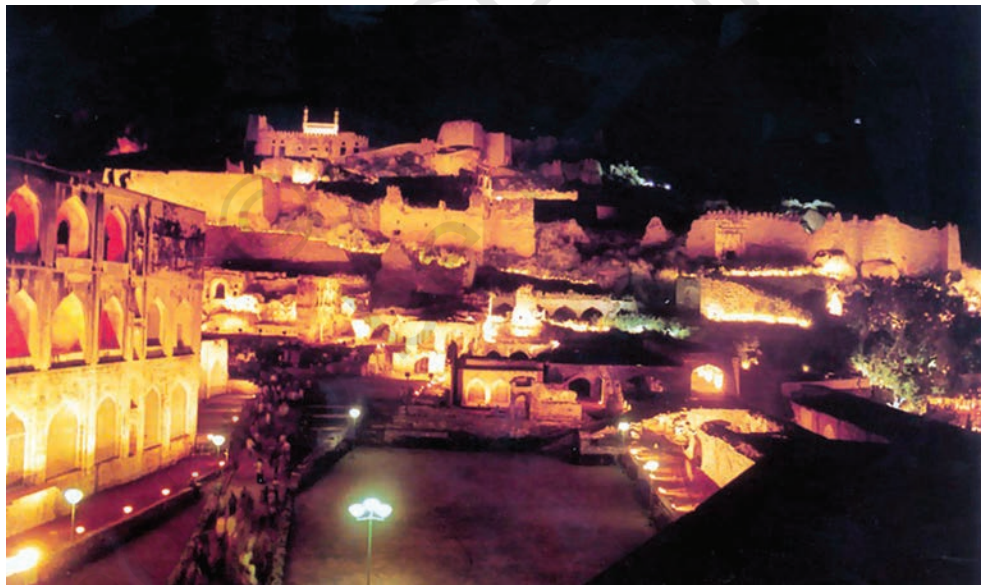

Golconda fort



Your elders might have cautioned you against touching an electrical appliance with wet hands. But do you know why it is dangerous to touch an electrical appliance with wet hands?

We have learnt earlier that the materials, which allow electric current to pass through them, are good conductors of electricity. On the other hand, materials, which do not allow electric current to pass through them easily, are poor conductors of electricity.

In Class VI, we made a tester to test whether a particular material allows the electric current to pass through it or not. Do you recall how the tester helped us in deciding that?

We found that metals such as copper and aluminium conduct electricity whereas materials such as rubber,

plastic and wood do not conduct electricity. However, so far we have used our tester to test materials which were in solid state. But what about liquids? Do liquids also conduct electricity? Let us find out.



Paheli and Boojho want to remind you that one should not experiment with the electric supply from the mains or a generator or an inverter. Use only electric cells for all the activities suggested here.



14.1 Do Liquids Conduct Electricity?

To test whether a liquid allows electric current to pass through it or not, we can use the same tester (Fig.14.1).

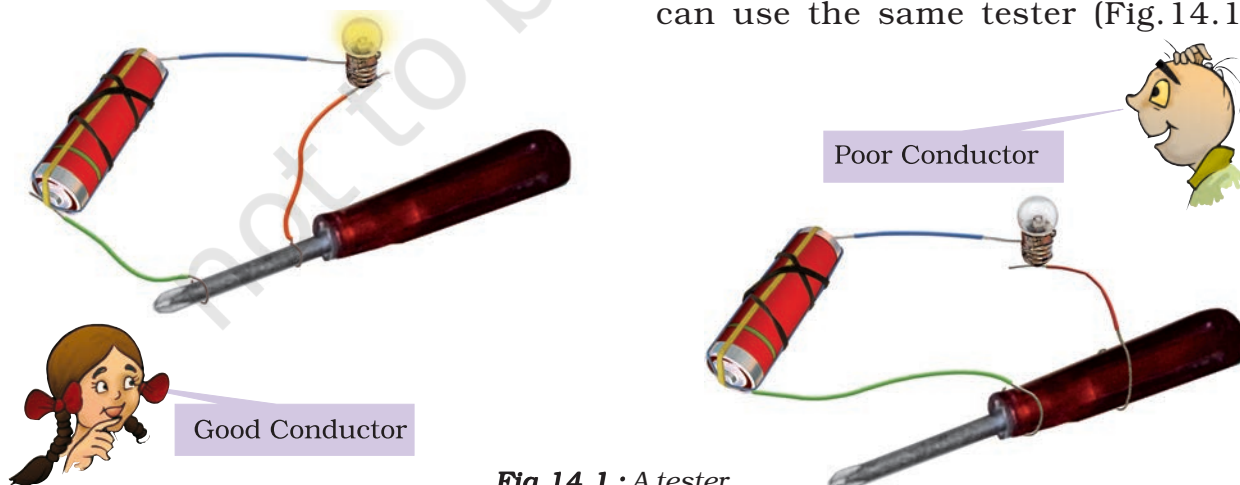

Fig.14.1 : A tester

However, replace the cell by a battery. Also, before using the tester we should check whether it is working or not.

Activity 14.1

Join the free ends of the tester together for a moment. This completes the circuit of the tester and the bulb should glow. However, if the bulb does not glow, it means that the tester is not working. Can you think of the possible reasons? Is it possible that the connections are loose? Or, the bulb is fused? Or, your cells are used up? Check that all the connections are tight. If they are, then replace the bulb with another bulb. Now test if the tester is working or not. If it is still not working then replace the cells with fresh cells.

Now that our tester is working, let us use it to test the various liquids.

(Caution: While checking your tester, do not join its free ends for more than a few seconds. Otherwise the cells of the battery will drain very quickly.)

Activity 14.2

Collect a few small plastic or rubber caps of discarded bottles and clean them. Pour one teaspoon of lemon juice or vinegar in one cap. Bring your tester over this cap and let the ends of the tester dip into lemon juice or vinegar as shown in Fig. 14.2. Take care that the ends are not more than 1 cm apart but at the same time do not touch each other. Does the bulb

of the tester glow? Does lemon juice or vinegar conduct electricity? How would you classify lemon juice or vinegar— a good conductor or a poor conductor?

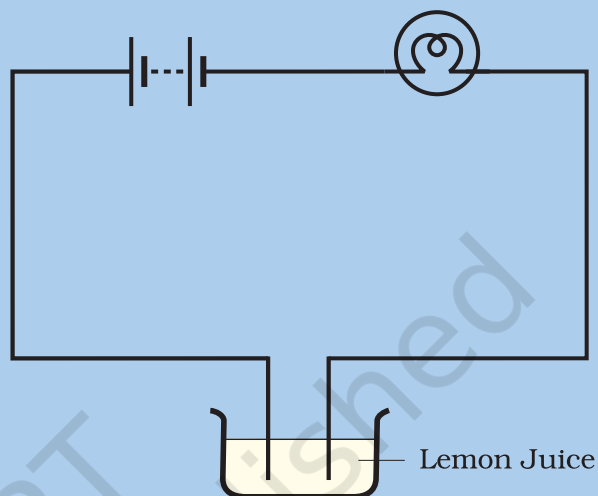

Fig. 14.2 : Testing conduction of electricity in lemon juice or vinegar

When the liquid between the two ends of the tester allows the electric current to pass, the circuit of the tester becomes complete. The current flows in the circuit and the bulb glows. When the liquid does not allow the electric current to pass, the circuit of the tester is not complete and the bulb does not glow.

In some situations even though the liquid is conducting, the bulb may not glow. It may have happened in Activity 14.2. What can be the reason?

Do you remember why the bulb glows when the electric current passes through it? Due to the heating effect of current, the filament of the bulb gets heated to a high temperature and it starts glowing. However, if the current through a circuit is too weak, the filament does not get heated

sufficiently and it does not glow. And why is the current in the circuit weak? Well, though a material may conduct electricity, it may not conduct it as easily as a metal. As a result, the circuit of the tester may be complete and yet the current through it may be too weak to make the bulb glow. Can we make another tester which can detect a weak current?

We can use another effect of an electric current to make another kind of tester. Do you recall that electric current produces a magnetic effect? What happens to a compass needle kept nearby when current flows in a wire? Even if the current is small, the deflection of the magnetic needle can be seen. Can we make a tester using the magnetic effect of currents? Let us find out in Activity 14.3.

You may use an LED (Fig. 14.3) in place of the electric bulb in the tester of Fig. 14.2. LED glows even when a weak electric current flows through it.

There are two wires (called leads) attached to an LED. One lead is slightly longer than the other. Remember that while connecting to a circuit, the longer lead is always connected to the positive terminal of the battery and the shorter lead is connected to the negative terminal of the battery.



Fig. 14.3 : LEDs

Activity 14.3

Take the tray from inside a discarded matchbox. Wrap an electric wire a few times around the tray. Place a small compass needle inside it. Now connect one free end of the wire to the terminal of a battery. Leave the other end free. Take another piece of wire and connect it to the other terminal of the battery (Fig. 14.4).

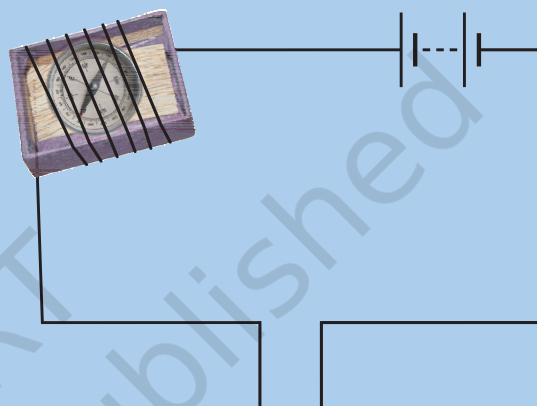

Fig 14.4 : Another tester

Join the free ends of two wires momentarily. The compass needle should show deflection. Your tester with two free ends of the wire is ready.

Now repeat Activity 14.2 using this tester. Do you find a deflection in the compass needle the moment you dip the free ends of the tester in lemon juice?

Take out the ends of the tester from the lemon juice, dip them in water and then wipe them dry. Repeat the activity with other liquids such as tap water, vegetable oil, milk, honey. *(Remember to wash and wipe dry the ends of tester after testing each liquid).* In each case observe whether the magnetic needle shows deflection or not. Record your observations in Table 14.1.

Table 14.1 : Good/Poor Conducting Liquids

S.No	Material	Compass Needle Shows Deflection Yes/No	Good Conductor/Poor Conductor
1.	Lemon juice	Yes	Good Conductor
2.	Vinegar		
3.	Tap Water		
4.	Vegetable oil		
5.	Milk		
6.	Honey		
7.			
8.			
9.			
10.			

From Table 14.1, we find that some liquids are good conductors of electricity and some are poor conductors.



When the free ends of the tester do not touch each other, there is an air gap between them. Paheli knows that air is a poor conductor of electricity. But she has also read that during lightning, an electric current passes through air. She wonders if air is indeed a poor conductor under all conditions. This makes Boojho ask whether other materials classified as poor conductors also allow electricity to pass under certain conditions.



Actually, under certain conditions most materials can conduct. That is why it is preferable to classify materials as good conductors and poor conductors instead of classifying as conductors and insulators.

We have tested the conduction of electricity through tap water. Let us now test the conduction of electricity through distilled water.

Activity 14.4

Take about two teaspoonfuls of distilled water in a clean and dry plastic or rubber cap of a bottle. *(You may obtain distilled water from your school science lab. You may also get distilled water from a medical store or a doctor or a nurse).* Use the tester to test whether distilled water conducts electricity or not. What do you find? Does distilled water conduct electricity? Now dissolve a pinch of common salt in distilled water. Again test. What do you conclude this time?

When salt is dissolved in distilled water, we obtain salt solution. This is a conductor of electricity.

The water that we get from sources such as taps, hand pumps, wells and ponds is not pure. It may contain several

salts dissolved in it. Small amounts of mineral salts are naturally present in it. This water is thus a good conductor of electricity. On the other hand, distilled water is free of salts and is a poor conductor.



Small amounts of mineral salts present naturally in water are beneficial for human health. However, these salts make water a good conductor. So, we should never handle electrical appliances with wet hands or while standing on a wet floor.

We have found that common salt, when dissolved in distilled water, makes it a good conductor. What are the other substances which, when dissolved in distilled water, make it conducting? Let us find out.

Caution: Do the next activity under the supervision of your teacher/parent or some elderly person, because the use of acid is involved in it.

Activity 14.5

Take three clean plastic or rubber caps of bottles. Pour about two teaspoonfuls of distilled water in each of them. Add a few drops of lemon juice or dilute hydrochloric acid to distilled water in one cap. Now in the second cap containing distilled water, add a few drops of a base such as caustic soda or potassium iodide. Add a little sugar to the distilled water in the third cap and dissolve it. Test which solutions conduct electricity and which do not. What results do you obtain?

Most liquids that conduct electricity are solutions of acids, bases and salts.

When an electric current flows through a conducting solution, does it produce an effect on the solution?

14.2 Chemical Effects of Electric Current

In Class VII, we have learnt some effects of electric current. Can you list these effects? What effect does the current produce when it flows through a conducting solution? Let us find out.

Activity 14.6

Take out carbon rods carefully from two discarded cells. Clean their metal caps with sand paper. Wrap copper wires around the metal caps of the carbon rods and join them to a battery (Fig. 14.5). We call these two rods **electrodes**. (*Instead of*

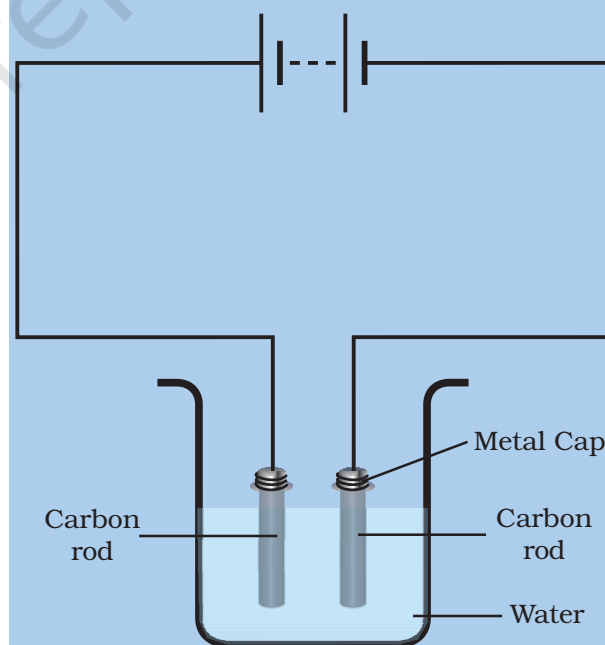
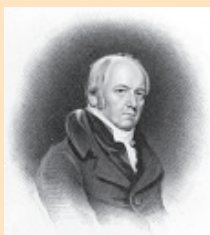

Fig.14.5 : Passing current through water

carbon rods, you may take two iron nails about 6 cm long.) Pour a cupful of water in a glass/plastic bowl. Add a teaspoonful of salt or a few drops of lemon juice to water to make it more conducting. Now immerse the electrodes in this solution. Make sure that the metal caps of the carbon rods are outside the water. Wait for 3-4 minutes. Observe the electrodes carefully. Do you notice any gas bubbles near the electrodes? Can we call the change taking place in the solution a chemical change? Recall the definition of a chemical change that you learnt in Class VII.

In 1800, a British chemist, William Nicholson (1753–1815), had shown that if electrodes were immersed in water, and a current was passed, bubbles of oxygen and hydrogen were produced. Oxygen bubbles formed on the electrode connected to the positive terminal of the battery and hydrogen bubbles formed on the other electrode.



The passage of an electric current through a conducting solution causes chemical reactions. As a result, bubbles of a gas may be formed on the electrodes. Deposits of metal may be seen on electrodes. Changes of colour of solutions may occur. The reaction would depend on what solution and electrodes are used. These are some of the chemical effects of the electric current.



Boojho decided to test whether some fruits and vegetables also conduct electricity or not. He cut a potato into two halves and inserted the copper wires of a tester into it. Just then his mother called him and he forgot to take out the wires of the tester inserted into the potato. When he came back after half an hour, he noticed that there was a greenish blue spot on the potato around one wire whereas there was no such spot around the other wire (Fig. 14.6).

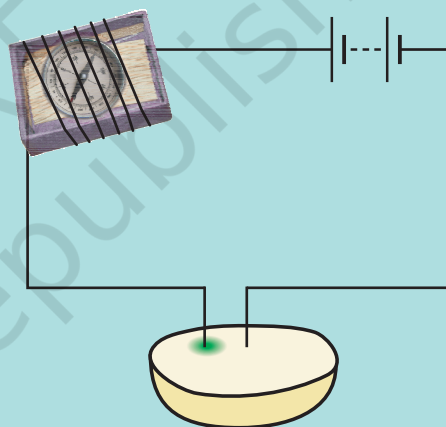

Fig. 14.6 : Testing potato

He was surprised with this observation and along with Paheli repeated this activity many times. They found that it was always the wire connected to the positive terminal, which had a greenish blue spot around it. They felt that this discovery was very useful because it could be used for identifying the positive terminal of a cell or a battery concealed in a box. They decided to report their finding to a children's magazine.

Remember that Boojho set out to test whether potato conducted

electricity or not. What he found was that current produced a chemical effect in the potato. To him this was very exciting. In fact, this is how science sometimes works. You are looking for something and you discover something else. Many important discoveries have been made in this manner.

14.3 Electroplating

You know that a brand new bicycle has shiny handlebar and wheel rims. However, if these are accidentally scratched, the shiny coating comes off revealing a not so shiny surface beneath. You might have also seen women using ornaments, which appear to be made of gold. However, with repeated use, the gold coating wears off, revealing silver or some other metal beneath.

In both these cases, a metal has a coating of another metal. Do you wonder how a layer of one metal can be deposited on top of another? Well, let us try doing it ourselves.

Activity 14.7

We will need copper sulphate and two copper plates of size around $10\text{ cm} \times 4\text{ cm}$. Take 250 mL of distilled water in a clean and dry beaker. Dissolve two teaspoonfuls of copper sulphate in it. Add a few drops of dilute sulphuric acid to copper sulphate solution to make it more conducting. Clean copper plates with sand paper. Now rinse them with water and dry them. Connect the copper plates to the terminals of a battery and immerse them in copper sulphate solution (Fig. 14.7).

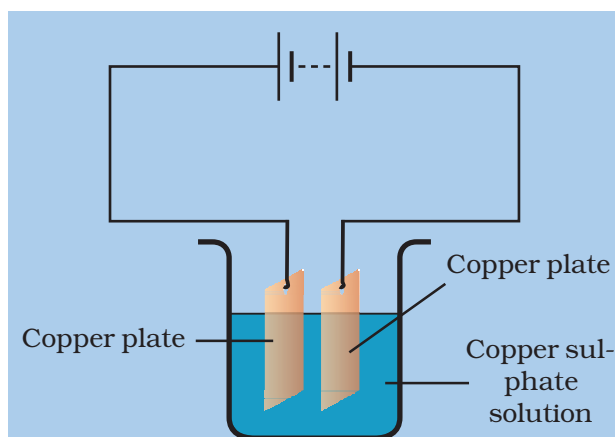

Fig.14.7 : A simple circuit showing electroplating

Allow the current to pass for about 15 minutes. Now remove the electrodes from the solution and look at them carefully. Do you find any difference in any one of them? Do you find a coating over it? What colour is the coating? Note down the terminal of the battery with which this electrode is connected.



After doing the electroplating activity, Paheli interchanged the electrodes and repeated the activity. What do you think she would observe this time?

When electric current is passed through the copper sulphate solution, copper sulphate dissociates into copper and sulphate. The free copper gets drawn to the electrode connected to the negative terminal of the battery and gets deposited on it. But what about the loss of copper from the solution?

From the other electrode, a copper plate, an equal amount of copper gets dissolved in the solution. Thus, the

loss of copper from the solution is restored and the process continues. This means that copper gets transferred from one electrode to the other.



Boojho could get only one copper plate. So he performed Activity 14.7 by connecting a carbon rod in place of the copper plate which was connected to the negative terminal of the battery. He succeeded in obtaining a coating of copper on carbon rod.

The process of depositing a layer of any desired metal on another material by means of electricity is called **electroplating**. It is one of the most common applications of chemical effects of electric current.

Electroplating is a very useful process. It is widely used in industry for coating metal objects with a thin layer of a different metal (Fig. 14.8). The layer of metal deposited has some desired property, which the metal of the object lacks. For example, chromium plating is done on many objects such as car parts, bath taps, kitchen gas burners, bicycle handlebars, wheel rims and many others.

Chromium has a shiny appearance. It does not corrode. It resists scratches. However, chromium is expensive and it may not be economical to make the whole object out of chromium. So the object is made from a cheaper metal and only a coating of chromium over it is deposited. Jewellery makers electroplate



Fig. 14.8 : Some electroplated objects

silver and gold on less expensive metals. These ornaments have the appearance of silver or gold but are much less expensive.

Tin cans, used for storing food, are made by electroplating tin onto iron. Tin is less reactive than iron. Thus, food does not come into contact with iron and is protected from getting spoilt.

Iron is used in bridges and automobiles to provide strength. However, iron tends to corrode and rust. So, a coating of zinc is deposited on iron to protect it from corrosion and formation of rust.

In the electroplating factories the disposal of the used conducting solution is a major concern. It is a polluting waste and there are specific disposal guidelines to protect the environment.

KEYWORDS

ELECTRODE

ELECTROPLATING

GOOD CONDUCTOR

LED

POOR CONDUCTOR

WHAT YOU HAVE LEARNT

- Some liquids are good conductors of electricity and some are poor conductors.
- Most liquids that conduct electricity are solutions of acids, bases and salts.
- The passage of an electric current through a conducting liquid causes chemical reactions. The resulting effects are called chemical effects of currents.
- The process of depositing a layer of any desired metal on another material, by means of electricity, is called electroplating.

Exercises

- Fill in the blanks.
 - Most liquids that conduct electricity are solutions of _____, _____ and _____.
 - The passage of an electric current through a solution causes _____ effects.
 - If you pass current through copper sulphate solution, copper gets deposited on the plate connected to the _____ terminal of the battery.
 - The process of depositing a layer of any desired metal on another material by means of electricity is called _____.
- When the free ends of a tester are dipped into a solution, the magnetic needle shows deflection. Can you explain the reason?
- Name three liquids, which when tested in the manner shown in Fig.14.9, may cause the magnetic needle to deflect.

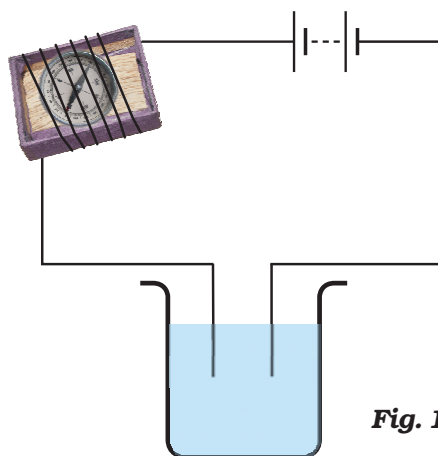

Fig. 14.9

4. The bulb does not glow in the setup shown in Fig. 14.10. List the possible reasons. Explain your answer.

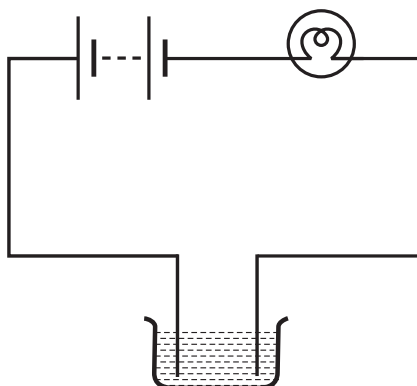

Fig. 14.10

5. A tester is used to check the conduction of electricity through two liquids, labelled A and B. It is found that the bulb of the tester glows brightly for liquid A while it glows very dimly for liquid B. You would conclude that
- liquid A is a better conductor than liquid B.
 - liquid B is a better conductor than liquid A.
 - both liquids are equally conducting.
 - conducting properties of liquid cannot be compared in this manner.
6. Does pure water conduct electricity? If not, what can we do to make it conducting?
7. In case of a fire, before the firemen use the water hoses, they shut off the main electrical supply for the area. Explain why they do this.
8. A child staying in a coastal region tests the drinking water and also the seawater with his tester. He finds that the compass needle deflects more in the case of seawater. Can you explain the reason?
9. Is it safe for the electrician to carry out electrical repairs outdoors during heavy downpour? Explain.
10. Paheli had heard that rainwater is as good as distilled water. So she collected some rainwater in a clean glass tumbler and tested it using a tester. To her surprise she found that the compass needle showed deflection. What could be the reasons?
11. Prepare a list of objects around you that are electroplated.
12. The process that you saw in Activity 14.7 is used for purification of copper. A thin plate of pure copper and a thick rod of impure copper are used as electrodes. Copper from impure rod is sought to be transferred to the thin copper plate. Which electrode should be attached to the positive terminal of the battery and why?

Extended Learning — Activities and Projects

1. Test the conduction of electricity through various fruits and vegetables. Display your result in a tabular form.
2. Repeat Activity 14.7 with a zinc plate in place of the copper plate connected to the negative terminal of the battery. Now replace zinc plate with some other metallic object and again repeat the activity. Which metal gets deposited over which other metal? Discuss your findings with your friends.
3. Find out if there is a commercial electroplating unit in your town. What objects are electroplated there and for what purpose? (The process of electroplating in a commercial unit is much more complex than what we did in Activity 14.7). Find out how they dispose off the chemicals they discard.
4. Imagine that you are an 'entrepreneur' and have been provided a loan by a bank to set up a small electroplating unit. What object would you like to electroplate and for what purpose? (Look up the meaning of 'entrepreneur' in a dictionary).
5. Find out the health concerns associated with chromium electroplating. How are people trying to resolve them?
6. You can make a fun pen for yourself. Take a conducting metal plate and spread a moist paste of potassium iodide and starch. Connect the plate to a battery as shown in Fig. 14.11. Now using the free end of the wire, write a few letters on the paste. What do you see?

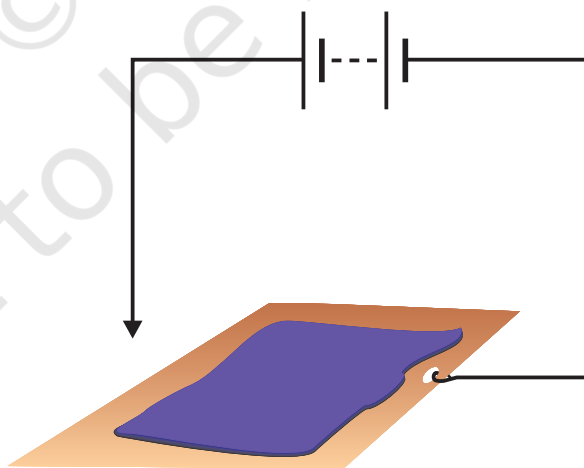

Fig. 14.11

For more information on this topic visit:

- electronics.howstuffworks.com/led.htm

Did You Know?

LEDs (Light Emitting Diodes) are available in many colours such as red, green, yellow, blue, white and are increasingly being used for many applications, for example in traffic signal lights. LEDs are increasingly being used for lighting. A cluster of white LEDs grouped together forms a LED light source. LED light sources consume less electricity and have longer lifetime than light bulbs and fluorescent tubes. Hence these are gradually becoming the preferred lighting source.





In Class VII, you read about winds, storms and cyclones. You learnt that cyclones can cause a lot of damage to human life and property. You also learnt that we can protect ourselves from these destructive phenomena to some extent. In this chapter we shall discuss two other destructive natural phenomena. These are lightning and earthquakes. We shall also discuss what steps we can take to minimise destruction caused by these phenomena.

15.1 Lightning

You might have seen sparks on a electric pole when wires become loose. This phenomenon is quite common when wind is blowing and shaking the wires. You might also have seen sparks when a plug is loose in its socket. Lightning is also an electric spark, but on a huge scale.

In ancient times, people did not understand the cause of these sparks. They were, therefore, afraid of lightning and thought that the wrath of gods was visiting them. Now, of course, we understand that lightning is caused by the accumulation of charges in the clouds. We need not be afraid of lightning, but we have to take

precautions to protect ourselves from the deadly sparks.

The Sparks that the Greeks Knew About

The ancient Greeks knew as early as 600 B.C. that when amber (amber is a kind of resin) was rubbed with fur, it attracted light objects such as hair. You might have seen that when you take off woollen or polyester clothes, your hair stands on end. If you take off these clothes in the dark, you even see a spark and hear a crackling sound. In 1752 Benjamin Franklin, an American scientist, showed that lightning and the spark from your clothes are essentially the same phenomena. However, it took 2000 years for this realisation to occur.

I wonder why they took so many years to realise the similarity.



Scientific discoveries are a result of hardwork by many people. It can sometimes take a long time.



We shall now study some properties of electric charges. We shall also see how

they are related to the lightning in the sky.

Let us perform some activities to understand the nature of electric charges. But recall first what you might have played as a game. When you rub a plastic scale on your dry hair, the scale can attract very small pieces of paper.

pieces of paper. Take care not to touch the rubbed end of the refill with your hand or with a metallic object. Repeat the activity with small pieces of dry leaf, husk and mustard seeds. Record your observations.

When a plastic refill is rubbed with polythene, it acquires a small electric charge. Similarly, when a plastic comb is rubbed with dry hair, it acquires a small charge. These objects are called **charged objects**. In the process of charging the refill and the plastic comb, polythene and hair also get charged.

Let's try to charge some other objects that are familiar to you.

15.2 Charging by Rubbing

Activity 15.1

Take a used ballpen refill and rub it vigorously with a piece of polythene. Bring it close to small

Activity 15.2

Collect the objects and the materials listed in Table 15.1. Try to charge each by rubbing with the materials mentioned in the Table. Record your findings. You can add more items to the Table.

Table 15.1

Objects Rubbed	Materials Used for Rubbing	Attracts/does not Attract Pieces of Paper	Charged/ Not Charged
Refill	Polythene, woollen cloth		
Balloon	Polythene, woollen cloth, dry hair		
Eraser	Wool		
Steel spoon	Polythene, woollen cloth		

15.3 Types of Charges and Their Interaction

We will select some objects from Table 15.1 for the next activity.

Activity 15.3

(a) Inflate two balloons. Hang them in such a way that they do not touch each other (Fig. 15.1). Rub both the balloons with a woollen cloth and release them. What do you observe?

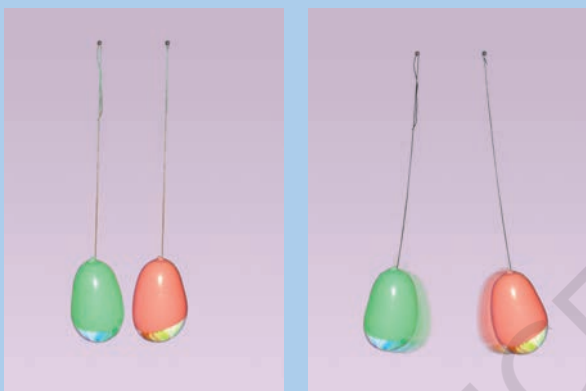

Fig. 15.1 : Like charges repel each other

Now let us repeat this activity with the used pen refills. Rub one refill with polythene. Place it carefully in a glass tumbler using the tumbler as a stand (Fig. 15.2).



Fig. 15.2 : Interaction between like charges

Rub the other refill also with polythene. Bring it close to the charged refill. Be careful not to touch the charged end with your hand. Is there any effect on the refill in the tumbler? Do the two attract each other, or repel each other?

In this activity we have brought close together the charged objects that were made of the same material. What happens if two charged objects made of different materials are brought close to each other? Let's find out.

(b) Rub a refill and place it gently in a glass tumbler as before (Fig. 15.3). Bring an inflated charged balloon near the refill and observe.



Fig. 15.3 : Unlike charges attract each other

Let's summarise the observations:

- A charged balloon repelled a charged balloon.
- A charged refill repelled a charged refill.
- But a charged balloon attracted a charged refill.

Does it indicate that the charge on the balloon is of a different kind from the charge on the refill? Can we say then, that there are two kinds of

charges? Can we also say that the charges of the same kind repel each other, while charges of different kind attract each other?

It is a convention to call the charge acquired by a glass rod when it is rubbed with silk as positive. The other kind of charge is said to be negative.

It is observed that when a charged glass rod is brought near a charged plastic straw rubbed with polythene there is attraction between the two.

What do you think would be the kind of charge on the plastic straw? Your guess, that the plastic straw would carry a negative charge is correct.

The electrical charges generated by rubbing are static. They do not move by themselves. When charges move, they constitute an electric current. You have been reading about electric current since Class VI. The current in a circuit which makes a bulb glow, or the current that makes a wire hot, is nothing but a motion of charges.

15.4 Transfer of Charge

Activity 15.4

Take an empty jam bottle. Take a piece of cardboard slightly bigger in size than the mouth of the bottle. Pierce a hole in it so that a metal paper clip can be inserted. Open out the paper clip as shown in Fig. 15.4. Cut two strips of aluminium foil about $4\text{ cm} \times 1\text{ cm}$ each. Hang them on the paper clip as shown. Insert the paper clip in the cardboard lid so that it is perpendicular to it (Fig. 15.4). Charge a refill and touch it

with the end of the paper clip. Observe what happens. Is there any effect on the foil strips? Do they repel each other or attract each other? Now, touch other charged bodies with the end of the paper clip. Do foil strips behave in the same way in all cases? Can this apparatus be used to detect whether a body is charged or not? Can you explain why the foil strips repel each other?



Fig 15.4 : A simple electroscope

The aluminium foil strips receive the same charge from the charged refill through the paper clip (remember that metals are good conductors of electricity). The strips carrying similar charges repel each other and they become wide open. Such a device can be used to test whether an object is carrying charge or not. This device is known as **electroscope**.

Thus, we find that electrical charge can be transferred from a charged object to another through a metal conductor.

Touch the end of the paper clip gently with hand and you will find a change in

the foil strips. They come back to their original state. Repeat charging of foil strips and touching the paper clip. Every time you will find that the foil strips collapse as soon as you touch the paperclip with hand. Why does it happen? The reason is that the foil strips lose charge to the earth through your body. We say that the foil strips are **discharged**. The process of transferring of charge from a charged object to the earth is called **earthing**.

Earthing is provided in buildings to protect us from electrical shocks due to any leakage of electrical current.

15.5 The Story of Lightning

It is now possible to explain lightning in terms of the charges produced by rubbing.

You learnt in Class VII that during the development of a thunderstorm, the air currents move upward while the water droplets move downward. These vigorous movements cause separation of charges. By a process, not yet completely understood, the positive charges collect near the upper edges of the clouds and the negative charges accumulate near the lower edges. There is accumulation of positive charges near the ground also. When the magnitude of the accumulated charges becomes very large, the air which is normally a poor conductor of electricity, is no longer able to resist their flow. Negative and positive charges meet, producing streaks of bright light and sound. We see streaks as lightning (Fig. 15.5). The process is called an electric discharge.

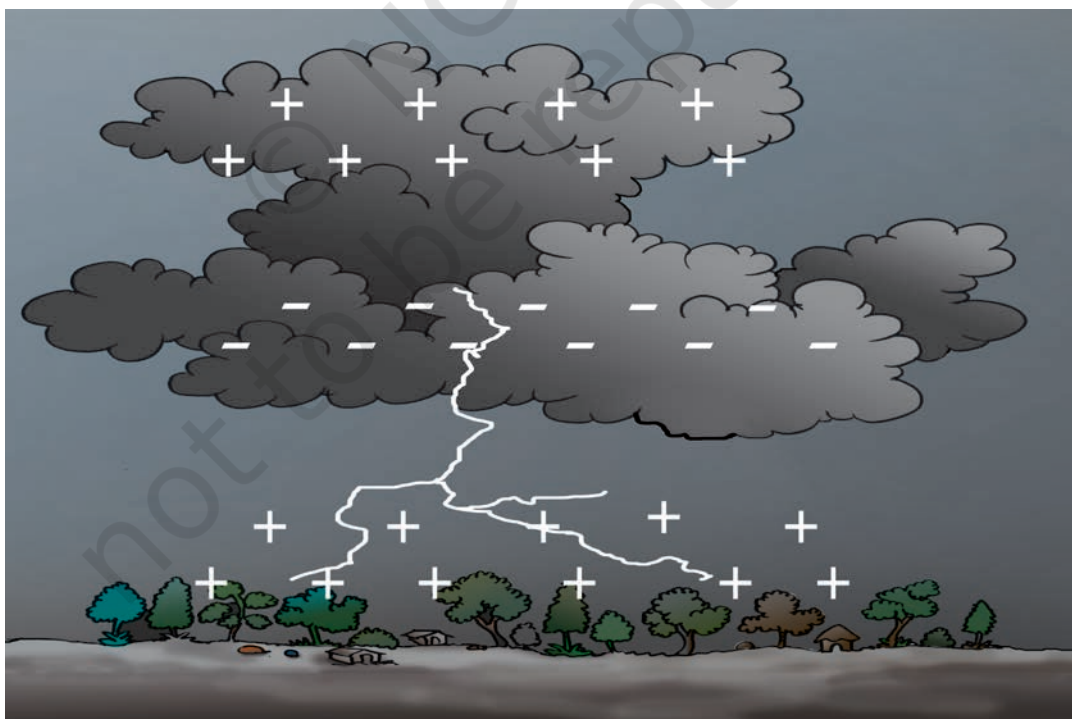

Fig 15.5 : Accumulation of charges leading to lightning.

The process of electric discharge can occur between two or more clouds, or between clouds and the earth. Today we need not get frightened by lightning like our ancestors did. Now we understand the basic phenomenon. Scientists are trying hard to improve this understanding. However, lightning strike could destroy life and property. It is, therefore, necessary to take measures to protect ourselves.

15.6 Lightning Safety

During lightning and thunderstorm no open place is safe.

- Hearing thunder is an alert to rush to a safer place.
- After hearing the last thunder, wait for some time before coming out of the safe place.

Finding a Safe Place

A house or a building is a safe place.

If you are travelling by car or by bus, you are safe inside with windows and doors of the vehicle shut.

Do's and Don'ts during a Thunderstorm

Outside

Open vehicles, like motorbikes, tractors, construction machinery, open cars are not safe. Open fields, tall trees, shelters in parks, elevated places do not protect us from lightning strokes.

Carrying an umbrella is not at all a good idea during thunderstorms.

If in a forest, take shelter under shorter trees.

If no shelter is available and you are in an open field, stay far away from all trees. Stay away from poles or other

metal objects. Do not lie on the ground. Instead, squat low on the ground. Place your hands on your knees with your head between the hands (Fig. 15.6). This position will make you the smallest target to be struck.



Fig. 15.6 : Safe position during lightning

Inside the house

Lightning can strike telephone cords, electrical wires and metal pipes (Do you remember, lightning is an electrical discharge?). During a thunderstorm contact with these should be avoided. It is safer to use mobile phones and cordless phones. However, it is not wise to call up a person who is receiving your phone through a wired phone.

Bathing should be avoided during thunderstorms to avoid contact with running water.

Electrical appliances like computers, TVs, etc., should be unplugged. Electrical lights can remain on. They do not cause any harm.

Lightning Conductors

Lightning Conductor is a device used to protect buildings from the effect of lightning. A metallic rod, taller than the building, is installed in the walls of the building during its construction. One end of the rod is kept out in the air and the other is buried deep in the ground (Fig. 15.7). The rod provides easy route for the transfer of electric charge to the ground.

The metal columns used during construction, electrical wires and water pipes in the buildings also protect us to an extent. But do not touch them during a thunderstorm.

15.7 Earthquakes

You just learnt about thunderstorm and lightning. In Class VII you learnt about cyclones. These natural phenomena can cause large scale destruction of human life and property. Fortunately, these phenomena can be predicted to some extent. The weather department can warn about a thunderstorm developing in some area.

If a thunderstorm occurs there is always a possibility of lightning and cyclones accompanying it. So, we get time to take measures to protect ourselves from the damage caused by these phenomena.

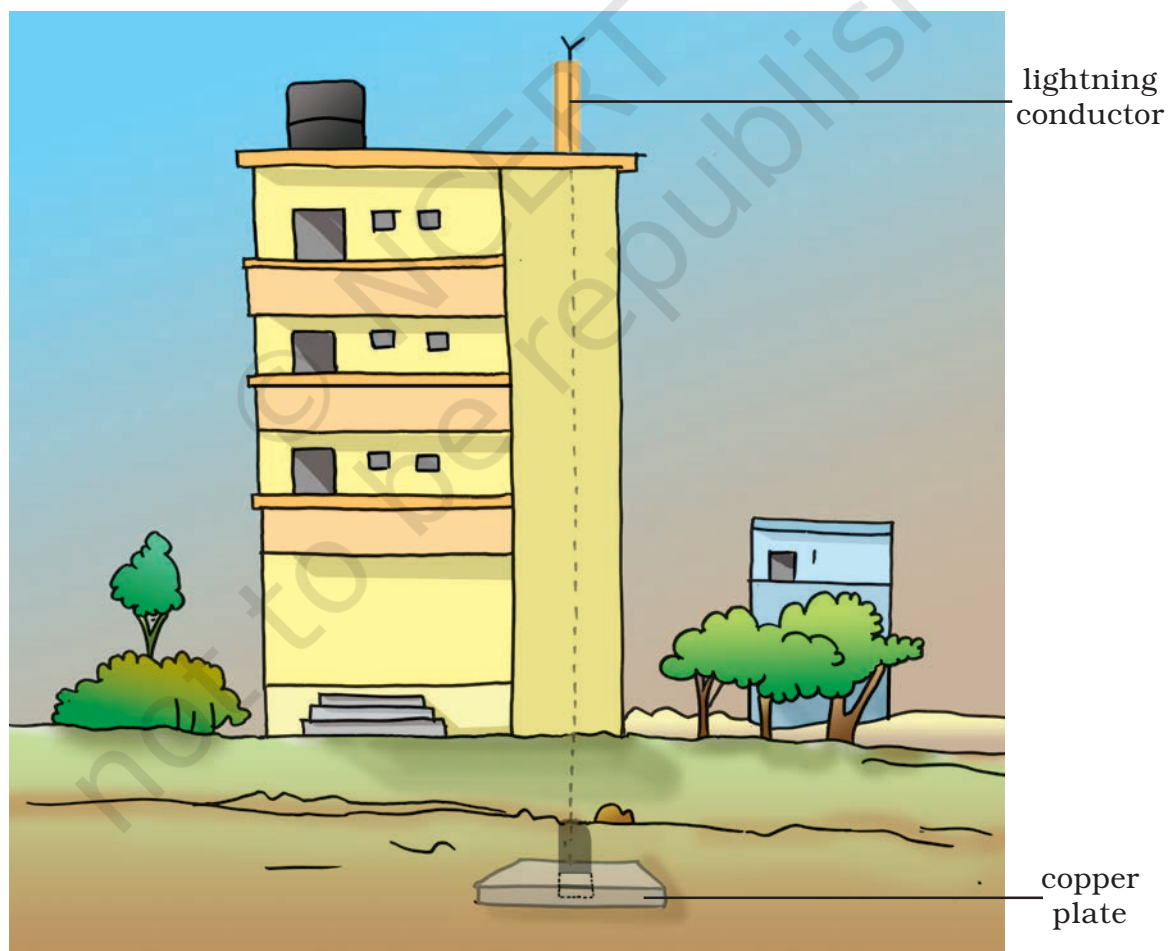

Fig. 15.7 : Lightning conductor

There is, however, one natural phenomenon which we are not yet able to predict accurately. It is an earthquake. It can cause damage to human life and property on a huge scale.

A major earthquake occurred in India on 8 October 2005 in Uri and Tangdhar towns of North Kashmir (Fig. 15.8). Before that a major earthquake occurred on 26 January 2001 in Bhuj district of Gujarat.

Activity 15.5

Ask your parents about the huge damage to life and property caused by these earthquakes. Collect a few pictures showing the damage

caused by these earthquakes from newspapers and magazines of those days. Prepare a short report on the suffering of the people during and after the earthquakes.

What is an earthquake? What happens when it occurs? What can we do to minimise its effects? These are some of the questions which we shall discuss below.

What is an Earthquake?

An earthquake is a sudden shaking or trembling of the earth which lasts for a very short time. It is caused by a disturbance deep inside the earth's



Fig. 15.8 : Kashmir earthquake

crust. Earthquakes occur all the time, all over the earth. They are not even noticed. Major earthquakes are much less frequent. They can cause immense damage to buildings, bridges, dams and people. There can be a great loss to life and property. Earthquakes can cause floods, landslides and tsunamis. A major tsunami occurred in the Indian Ocean on 26 December 2004. All the coastal areas around the ocean suffered huge losses.

Activity 15.6

Take an outline map of the world. Locate the eastern coast and Andaman and Nicobar Islands in India. Mark other countries around the Indian Ocean which could have suffered damage. Collect accounts of the devastation caused by the tsunami in India from your parents, or other elders in the family or in the neighbourhood.

What Causes an Earthquake?



My grandmother told me that the earth is balanced on the horn of a bull and when the bull shifts it to the other horn, an earthquake takes place. How could it be true?

In ancient times, people did not know the true cause of earthquakes. Their ideas were, therefore, expressed in mythical stories such as the one told by Boojho's grandmother. Similar myths were prevalent in other parts of the world.

What could cause a disturbance inside the earth?



Now we know that the tremors are caused by the disturbance deep down inside the uppermost layer of the earth called the crust (Fig. 15.9).

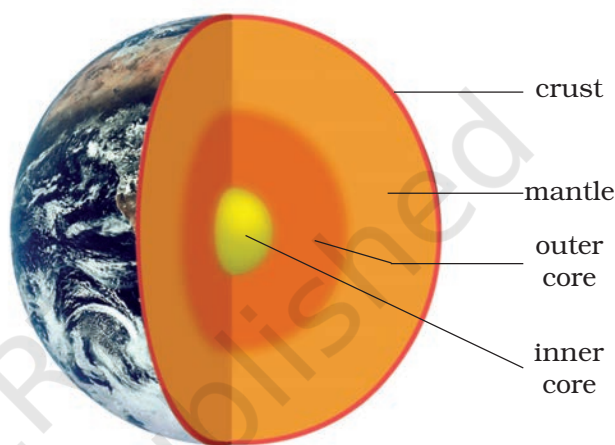

Fig. 15.9 : Structure of the earth

The outermost layer of the earth is not in one piece. It is fragmented. Each fragment is called a plate (Fig. 15.10). These plates are in continual motion. When they brush past one another, or

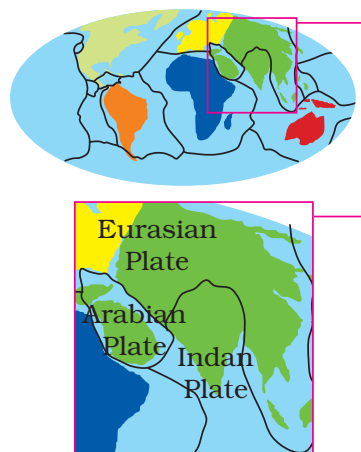

Fig. 15.10 : Earth plates

a plate goes under another due to collision (Fig. 15.11), they cause disturbance in the earth's crust. It is this disturbance that shows up as an earthquake on the surface of the earth.

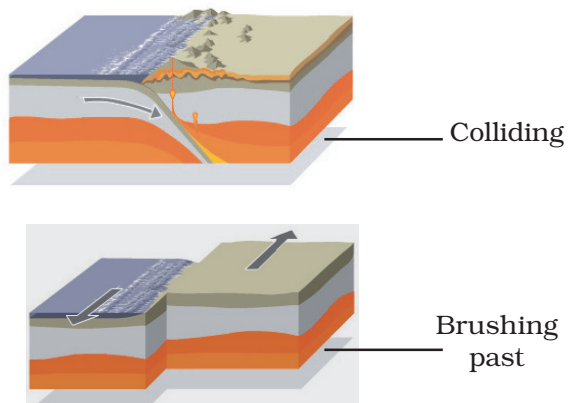

Fig. 15.11 : Movements of earth's plates



If scientists know so much about earthquakes, can they also predict when and where the next one will strike?

Although, we know for sure what causes an earthquake, it is not yet possible to predict when and where the next earthquake might occur.



I read somewhere that underground explosions could also cause tremors.

Tremors on the earth can also be caused when a volcano erupts, or a meteor hits the earth, or an underground nuclear explosion is

carried out. However, most earthquakes are caused by the movement of earth's plates.

Since earthquakes are caused by the movement of plates, the boundaries of the plates are the weak zones where earthquakes are more likely to occur. The weak zones are also known as **seismic** or **fault zones**. In India, the areas most threatened are Kashmir, Western and Central Himalayas, the whole of North-East, Rann of Kutch, Rajasthan and the Indo-Gangetic Plane. Some areas of South India also fall in the danger zone (Fig. 15.12).



Fig. 15.12 : Movements of Indian earth's plate

The power of an earthquake is expressed in terms of a magnitude on a scale called the **Richter scale**. Really destructive earthquakes have magnitudes higher than 7 on the Richter scale. Both Bhuj and Kashmir earthquakes had magnitudes greater than 7.5.

The tremors produce waves on the surface of the earth. These are called seismic waves. The waves are recorded by an instrument called the **seismograph** (Fig. 15.13). The instrument is simply a vibrating rod, or a pendulum, which starts vibrating when tremors occur. A pen is attached to the vibrating system. The pen records the seismic waves on a paper which moves under it. By studying these waves, scientists can construct a complete map of the earthquake, as shown in Fig. 15.14. They can also estimate its power to cause destruction.

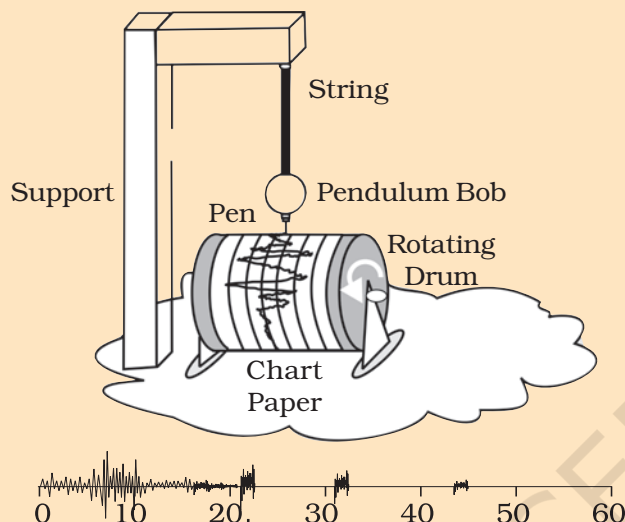

A typical seismograph record

Fig. 15.13 : A seismograph

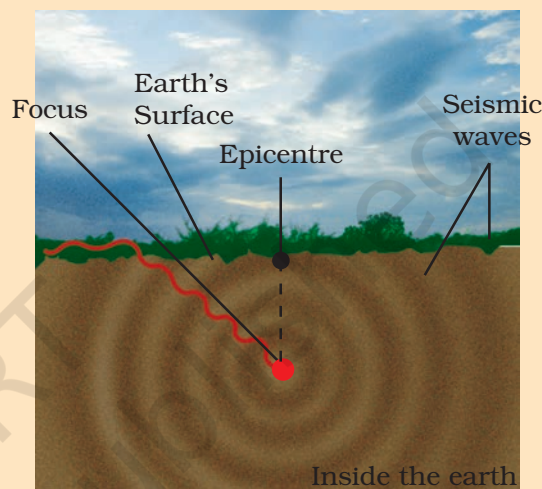

Fig. 15.14 : Map of the earthquake

Like many other scales in science (decibel is another example), Richter scale is not linear. This means that an earthquake of magnitude 6 does not have one and half times the destructive energy of an earthquake of magnitude 4. In fact, an increase of 2 in magnitude means 1000 times more destructive energy. Therefore, an earthquake of magnitude 6 has thousand times more destructive energy than an earthquake of magnitude 4.

Protection against Earthquakes

We know from the earlier pages that earthquakes cannot be predicted. We have also seen that they can be highly destructive. It is, therefore, important that we take necessary precautions to protect ourselves all the time. People

living in seismic zones, where the earthquakes are more likely to occur, have to be specially prepared. First of all, the buildings in these zones should be so designed that they can withstand major tremors. Modern building technology can make it possible.

It is advisable to make the structure simple so that it is 'Quake Safe'.

- Consult qualified architects and structural engineers.
- In highly seismic areas, the use of mud or timber is better than using heavy construction material. Keep roofs as light as possible. In case the structure falls, the damage will not be heavy.
- It is better if the cupboards and shelves are fixed to the walls, so that they do not fall easily.
- Be careful where you hang wall clocks, photo-frames, water heaters etc., so that in the event of an earthquake, they do not fall on people.
- Since some buildings may catch fire due to an earthquake, it is necessary that all buildings, especially tall buildings, have fire fighting equipment in working order.

The Central Building Research Institute, Roorkee, has developed knowhow to make quake-resistant houses.

In the event that an earthquake does strike, take the following steps to protect yourself.

1. If you are at home

- Take shelter under a table and stay there till the shaking stops.
- Stay away from tall and heavy objects that may fall on you.
- If you are in bed, do not get up. Protect your head with a pillow.

2. If you are outdoors

- Find a clear spot, away from buildings, trees and overhead power lines. Drop to the ground.
- If you are in a car or a bus, do not come out. Ask the driver to drive slowly to a clear spot. Do not come out till the tremors stop.

KEYWORDS

CRUST

DISCHARGE

EARTH'S PLATES

EARTHQUAKE

ELECTROSCOPE

LIGHTNING

LIGHTNING
CONDUCTOR

NEGATIVE CHARGE

POSITIVE CHARGE

RICHTER SCALE

SEISMOGRAPH

THUNDER

THUNDERSTORM

TRANSFER OF
CHARGE

TSUNAMI

TREMOR

WHAT YOU HAVE LEARNT

- Some objects can be charged by rubbing with other objects.
- There are two kinds of charges — positive charge and negative charge
- Like charges repel and unlike charges attract each other.
- The electrical charges produced by rubbing are called static charges.
- When charges move, they constitute an electric current.
- An electroscope may be used to detect whether a body is charged or not.
- The process of transfer of charge from a charged object to the earth is called earthing.
- The process of electric discharge between clouds and the earth or between different clouds causes lightning.
- Lightning strike could destroy life and property.
- Lightning conductors can protect buildings from the effects of lightning.
- An earthquake is a sudden shaking or trembling of the earth.
- Earthquake is caused by a disturbance deep inside the earth's crust.
- It is not possible to predict the occurrence of an earthquake.
- Earthquakes tend to occur at the boundaries of earth's plates. These boundaries are known as fault zones.
- Destructive energy of an earthquake is measured on the Richter scale. The earthquake measuring 7 or more on Richter scale can cause severe damage to life and property.
- We should take necessary precautions to protect ourselves from earthquakes.

Exercises

Select the correct option in Questions 1 and 2.

- Which of the following cannot be charged easily by friction?
 - A plastic scale
 - A copper rod
 - An inflated balloon
 - A woollen cloth.
- When a glass rod is rubbed with a piece of silk cloth the rod
 - and the cloth both acquire positive charge.
 - becomes positively charged while the cloth has a negative charge.
 - and the cloth both acquire negative charge.
 - becomes negatively charged while the cloth has a positive charge.
- Write T against true and F against false in the following statements.
 - Like charges attract each other (T/F)
 - A charged glass rod attract a charged plastic straw (T/F)
 - Lightning conductor cannot protect a building from lightning (T/F)
 - Earthquakes can be predicted in advance (T/F)
- Sometimes, a crackling sound is heard while taking off a sweater during winters. Explain.
- Explain why a charged body loses its charge if we touch it with our hand.
- Name the scale on which the destructive energy of an earthquake is measured. An earthquake measures 3 on this scale. Would it be recorded by a seismograph? Is it likely to cause much damage?
- Suggest three measures to protect ourselves from lightning.
- Explain why a charged balloon is repelled by another charged balloon whereas an uncharged balloon is attracted by another charged balloon?
- Describe with the help of a diagram an instrument which can be used to detect a charged body.
- List three states in India where earthquakes are more likely to strike.
- Suppose you are outside your home and an earthquake strikes. What precaution would you take to protect yourself?
- The weather department has predicted that a thunderstorm is likely to occur on a certain day. Suppose you have to go out on that day. Would you carry an umbrella? Explain.

Extended Learning — Activities and Projects

1. Open a water tap. Adjust the flow so that it forms a thin stream. Charge a refill. Bring it near the water stream. Observe what happens. Write a short report on the activity.
2. Make your own charge detector. Take a paper strip roughly $10\text{ cm} \times 3\text{ cm}$. Give it a shape as shown in Fig. 15.15. Balance it on a needle. Bring a charged body near it. Observe what happens. Write a brief report, explaining its working.

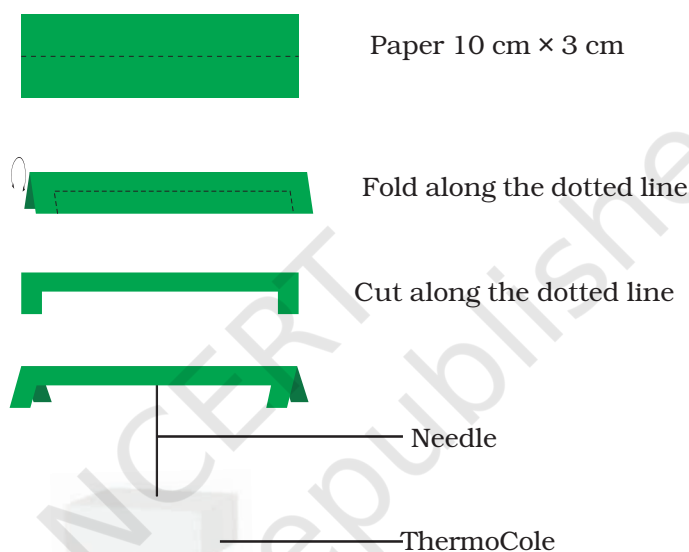

Fig. 15.15

3. This activity should be performed at night. Go to a room where there is a fluorescent tube light. Charge a balloon. Switch off the tube light so that the room is completely dark. Bring the charged balloon near the tubelight. You should see a faint glow. Move the balloon along the length of the tube and observe how the glow changes.

Caution : Do not touch the metal parts of the tube or the wires connecting the tube with the mains.

4. Find out if there is an organisation in your area which provides relief to those suffering from natural disaster. Enquire about the type of help they render to the victims of earthquakes. Prepare a brief report on the problems of the earthquake victims.

For more information on these topics, visit:

- science.howstuffworks.com/lightning.htm
- science.howstuffworks.com/earthquake.htm

CHAPTER 16 LIGHT



0854CH16

The world is largely known through the senses. The sense of sight is one of the most important senses. Through it we see mountains, rivers, trees, plants, chairs, people and so many other things around us. We also see clouds, rainbows and birds flying in the sky. At night we see the moon and the stars. You are able to see the words and sentences printed on this page. How is seeing made possible?

16.1 What makes Things Visible

Have you ever thought how we see various objects? You may say that eyes see the objects. But, can you see an object in the dark? It means that eyes alone cannot see any object. It is only when light from an object enters our eyes that we see the object. The light may have been emitted by the object, or may have been reflected by it.

You learnt in Class VII that a polished or a shiny surface can act as a mirror. A mirror changes the direction of light that falls on it. Can you tell in which direction the light falling on a surface will be reflected? Let us find out.

16.2 Laws of Reflection

Activity 16.1

Fix a white sheet of paper on a drawing board or a table. Take a

comb and close all its openings except one in the middle. You can use a strip of black paper for this purpose. Hold the comb perpendicular to the sheet of paper. Throw light from a torch through the opening of the comb from one side (Fig. 16.1). With slight adjustment of the torch and the comb you will see a ray of light along the paper on the other side of the comb. Keep the comb and the torch steady. Place a strip of plane mirror in the path of the light ray (Fig. 16.1). What do you observe?



Fig. 16.1 : Arrangement for showing reflection

After striking the mirror, the ray of light is reflected in another direction. The light ray, which strikes any surface, is called the **incident ray**. The ray that comes back from the surface after reflection is known as the **reflected ray**.

A ray of light is an idealisation. In reality, we have a narrow beam of light which is made up of several rays. For simplicity, we use the term ray for a narrow beam of light.

Draw lines showing the position of the plane mirror, the incident ray and the reflected ray on the paper with the help of your friends. Remove the mirror and the comb. Draw a line making an angle of 90° to the line representing the mirror at the point where the incident ray strikes the mirror. This line is known as the **normal** to the reflecting surface at that point (Fig. 16.2). The angle



Fig. 16.2 : Drawing the normal

between the normal and incident ray is called the **angle of incidence ($\angle i$)**. The angle between the normal and the reflected ray is known as the **angle of reflection ($\angle r$)** (Fig. 16.3). Measure the angle of incidence and the angle of reflection. Repeat the activity several times by changing the angle of incidence. Enter the data in Table 16.1.

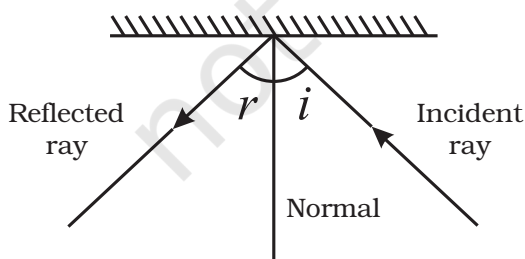

Fig. 16.3 : Angle of incidence and angle of reflection

Table 16.1 : Angles of Incidence and Reflection

S. No.	Angle of Incidence ($\angle i$)	Angle of Reflection ($\angle r$)
1.		
2.		
3.		
4.		
5.		

Do you see any relation between the angle of incidence and the angle of reflection. Are they approximately equal? If the experiment is carried out carefully, it is seen that the **angle of incidence is always equal to the angle of reflection**. This is one of the **laws of reflection**. Let us perform another activity on reflection.



What would happen if I threw the light on the mirror along the normal.

Activity 16.2

Perform Activity 16.1 again. This time use a sheet of stiff paper or a chart paper. Let the sheet project a little beyond the edge of the Table (Fig. 16.4). Cut the projecting portion of the sheet in the middle. Look at the reflected ray. Make sure that the reflected ray extends to the projected portion of the paper. Bend that part of the projected portion on which the reflected ray falls. Can you still see the reflected ray? Bring the paper back to the original

position. Can you see the reflected ray again? What do you infer?

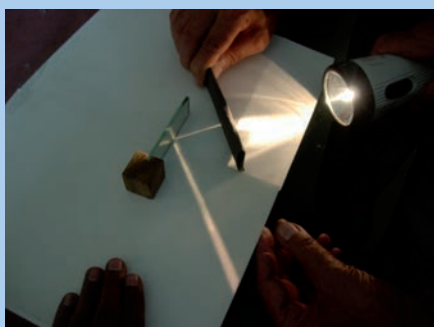

(a)

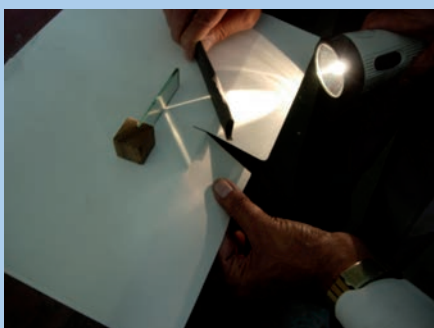

(b)

Fig. 16.4 (a), (b) : Incident ray, reflected ray and the normal at the point of incidence lie in the same plane

When the whole sheet of paper is spread on the table, it represents one plane. The incident ray, the normal at the point of incidence and the reflected ray are all in this plane. When you bend the paper you create a plane different from the plane in which the incident ray and the normal lie. Then you do not see the reflected ray. What does it indicate? It indicates that **the incident ray, the normal at the point of incidence and the reflected ray all lie in the same plane**. This is another law of reflection.

Paheli and Boojho performed the above activities outside the classroom

with the Sun as the source of light instead of a torch. You, too, can use the Sun as the source of light.

These activities can also be performed by making use of the Ray Streak Apparatus (available in the kit prepared by NCERT).

Boojho remembered that in Class VII, he had studied some features of the image of an object formed by a plane mirror. Paheli asked him to recall those features:

- (i) Was the image erect or upside down?
- (ii) Was it of the same size as the object?
- (iii) Did the image appear at the same distance behind the mirror as the object was in front of it?
- (iv) Could it be obtained on a screen?

Let us understand a little more about the formation of an image by a plane mirror in the following way:

Activity 16.3

A source of light O is placed in front of a plane mirror PQ . Two rays OA and OC are incident on it (Fig. 16.5). Can you find out the direction of the reflected rays?

Draw normals to the surface of the mirror PQ , at the points A and C . Then draw the reflected rays at the points A and C . How would you draw these rays? Call the reflected rays AB and CD , respectively. Extend them further. Do they meet? Extend them backwards. Do they meet now? If they meet, mark this point as I . For a viewer's eye at E (Fig. 16.5), do the reflected rays

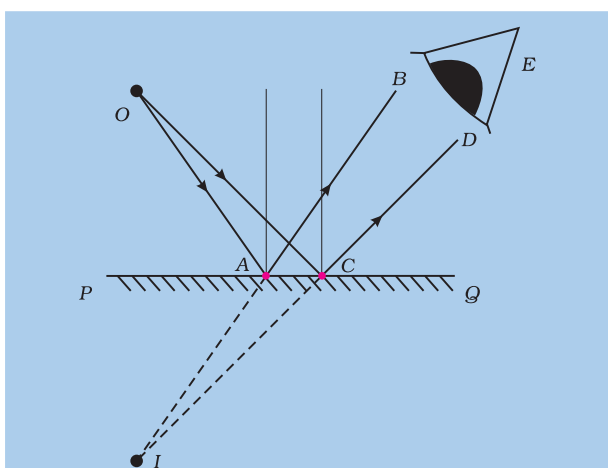

Fig. 16.5 : Image formation in a plane mirror

appear to come from the point I. Since the reflected rays do not actually meet at I, but only appear to do so, we say that a virtual image of the point O is formed at I. As you have learnt already in Class VII, such an image cannot be obtained on a screen.

You may recall that in an image formed by a mirror the left of the object appears on the right and the right appears on the left. This is known as **lateral inversion**.

16.3 Regular and Diffused Reflection

Activity 16.4

Imagine that parallel rays are incident on an irregular surface as shown in Fig. 16.6. Remember that the laws of reflection are valid at each point of the surface. Use these laws to construct reflected rays at various points. Are they parallel to one another? You will find that these rays are reflected in different directions. (Fig. 16.7)

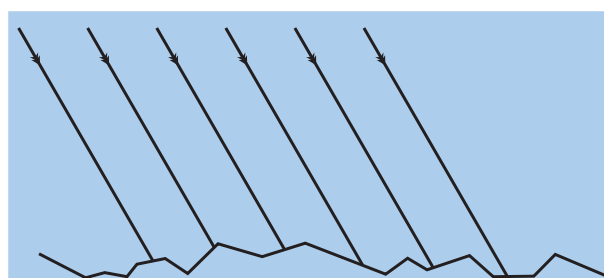

Fig. 16.6 : Parallel rays incident on an irregular surface

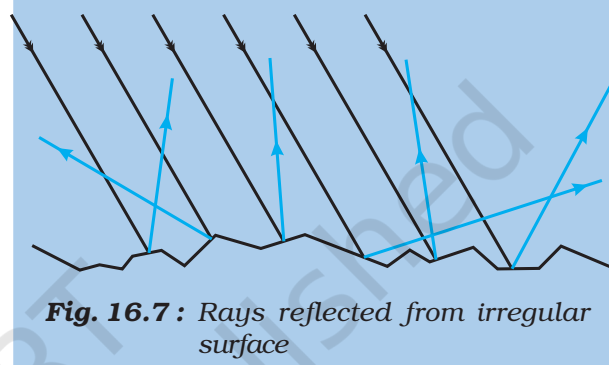

Fig. 16.7 : Rays reflected from irregular surface

When all the parallel rays reflected from a rough or irregular surface are not parallel, the reflection is known as **diffused** or **irregular** reflection. Remember that the diffused reflection is not due to the failure of the laws of reflection. It is caused by the irregularities in the reflecting surface, like that of a cardboard.

On the other hand, reflection from a smooth surface like that of a mirror is called **regular reflection** (Fig. 16.8). Images are formed by regular reflection.

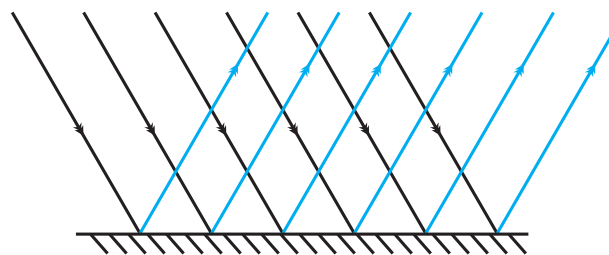

Fig. 16.8 : Regular reflection

Do We See all Objects due to Reflected Light?

Nearly everything you see around is seen due to reflected light. Moon, for example, receives light from the Sun and reflects it. That's how we see the moon. The objects which shine in the light of other objects are called illuminated objects. Can you name some other such objects?

There are other objects, which give their own light, such as the Sun, fire, flame of a candle and an electric lamp. Their light falls on our eyes. That is how we see them. The objects which emit their own light are known as luminous objects.



I have a question. Can the reflected rays be further reflected if incident on another mirror?

Let us find out.

16.4 Reflected Light Can be Reflected Again

Recall the last time you visited a hair dresser. She/he makes you sit in front of a mirror. After your hair cut is complete, she/he holds a mirror behind you to show you how the hair has been cut (Fig. 16.9). Do you know how you could see the hair at the back of your head?

Paheli recalls having constructed a periscope as an Extended Activity in Class VI. The periscope makes use of two plane mirrors. Can you explain how reflection from the two mirrors enables you to see objects which are not visible directly? Periscopes are used in submarines, tanks and also by soldiers in bunkers to see things outside.

16.5 Multiple Images

You are aware that a plane mirror forms only a single image of an object. What happens if two plane mirrors are used in combination? Let us see.



Fig. 16.9 : Mirror at the hair dresser shop

Activity 16.5

Take two plane mirrors. Set them at right angles to each other with their edges touching (Fig. 16.10). To hinge them you can use adhesive tape. Place a coin in between the mirrors. How many images of the coin do you see (Fig. 16.10)?



Fig. 16.10 : Images in plane mirror at right angle to each other

Now hinge the mirrors using the adhesive tape at different angles, say 45° , 60° , 120° , 180° etc. Place some object (say a candle) in between them. Note down the number of images of the object in each case.

Finally, set the two mirrors parallel to each other. Find out how many images of a candle placed between them are formed (Fig. 16.11).

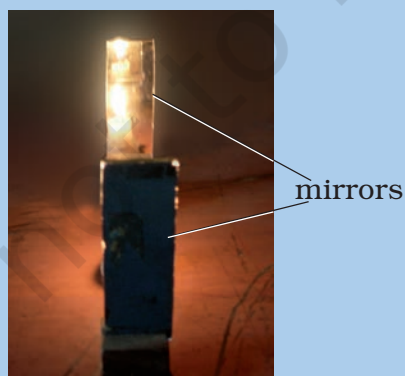

Fig. 16.11 : Image in plane mirror parallel to each other

Can you now explain how you can see the back of your head at the hair dresser's shop?

This idea of number of images formed by mirrors placed at an angle to one another is used in a kaleidoscope to make numerous beautiful patterns. You can also make a kaleidoscope yourself.

Kaleidoscope

Activity 16.6

To make a kaleidoscope, get three rectangular mirror strips each about 15 cm long and 4 cm wide. Join them together to form a prism as shown in Fig. 16.12(a). Fix this arrangement of mirrors in a circular cardboard tube or tube of a thick chart paper. Make sure that the tube is slightly longer than the mirror strips. Close one end of the tube by a cardboard disc having a hole in the centre, through which you can see [Fig. 16.12(b)]. To make the disc durable, paste a piece of transparent plastic sheet under the cardboard

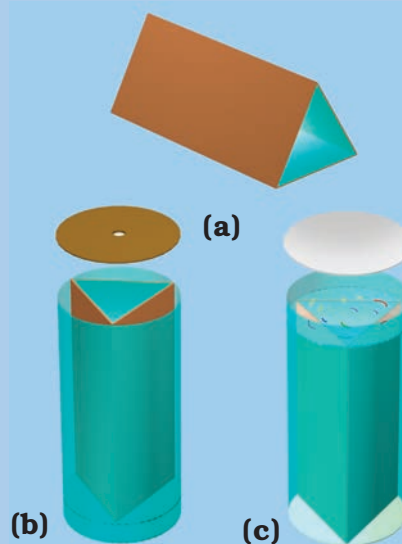

Fig. 16.12 : Making a kaleidoscope

disc. At the other end, touching the mirrors, fix a circular plane glass plate [Fig. 16.12(c)]. Place on this glass plate several small pieces of coloured glass (broken pieces of coloured bangles). Close this end of the tube by a ground glass plate. Allow enough space for the colour pieces to move around.

Your kaleidoscope is ready. When you peep through the hole, you will be able to see a variety of patterns in the tube. An interesting feature of a kaleidoscope is that you will never see the same pattern again. Designers of wallpapers and fabrics and artists often use kaleidoscopes to get ideas for new patterns. To make your toy attractive, you can wrap the kaleidoscope in a coloured paper.

Activity 16.7

Get a plane mirror of a suitable size. Place it in a bowl (katori) as shown in Fig. 16.13. Fill the bowl with water. Put this arrangement near a window in such a way that direct sunlight falls on the mirror. Adjust the position of the bowl so that the reflected light from the mirror falls on a wall. If the wall is not white, fix a sheet of white paper on it. Reflected light will be seen to have many colours. How can you explain this? The mirror and water form a

16.6 Sunlight — White or Coloured

In Class VII, you learnt that the sunlight is referred to as white light. You also learnt that it consists of seven colours. Here is another activity (Activity 16.7) showing that sunlight consists of several colours.

16.7 What is inside Our Eyes?

We see things only when light coming from them enters our eyes. Eye is one of our most important sense organs. It is, therefore, important to understand its structure and working.

The eye has a roughly spherical shape. The outer coat of the eye is white. It is tough so that it can protect the interior of the eye from accidents. Its transparent front part is called

prism. As you learnt in Class VII, this breaks up the light into its colours. Splitting of light into its colours is known as **dispersion** of light. Rainbow is a natural phenomenon showing dispersion.



Fig. 16.13 : Dispersion of light

cornea (Fig. 16.14). Behind the cornea, we find a dark muscular structure called **iris**. In the iris, there is a small opening called the pupil. The size of the **pupil** is controlled by the iris. The iris is that part of eye which gives it its distinctive colour. When we say that a person has green eyes, we refer actually to the colour of the iris. The iris controls the amount of light entering into the eye. Let us see how.

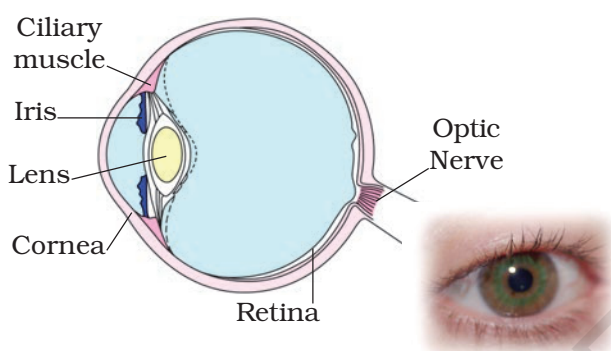

Fig. 16.14 : Human eye

Caution : For this activity, never use a laser torch.

Activity 16.8

Look into your friend's eye. Observe the size of the pupil. Throw light on her eye with a torch. Observe the pupil now. Switch off the torch, and observe her pupil once again. Do you notice any change in the size of the pupil? In which case was the pupil larger? Why do you think it was so?

In which case do you need to allow more light in the eye, when the light is dim or bright?

Behind the pupil of the eye is a lens which is thicker in the centre. What kind of lens is thicker at the centre? Recall what you learnt about lenses in

Class VII. The lens focuses light on the back of the eye, on a layer called **retina** (Fig. 16.14). The retina contains several nerve cells. Sensations felt by the nerve cells are then transmitted to the brain through the optic nerve. There are two kinds of cells—

- (i) cones, which are sensitive to bright light and
- (ii) rods, which are sensitive to dim light.

Cones sense colour. At the junction of the optic nerve and the retina, there are no sensory cells, so no vision is possible at that spot. This is called the **blind spot**. Its existence can be demonstrated as follows:

Activity 16.9

Make a round mark and a cross on a sheet of paper with the spot to the right of the cross (Fig. 16.15). The distance between two marks may be 6-8 cm. Hold the sheet of paper at an arm's length from the eye. Close your left eye. Look continuously at the cross. Move the sheet slowly towards you, keeping your eye on the cross. What do you find? Does the round mark disappear at some point? Now close your right eye. Look at the round mark now and repeat the activity. Does the cross disappear? The disappearance of the cross or the round mark shows that there is a point on the retina which cannot send messages to the brain when light falls on it.

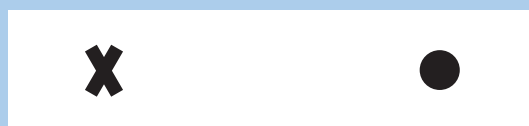
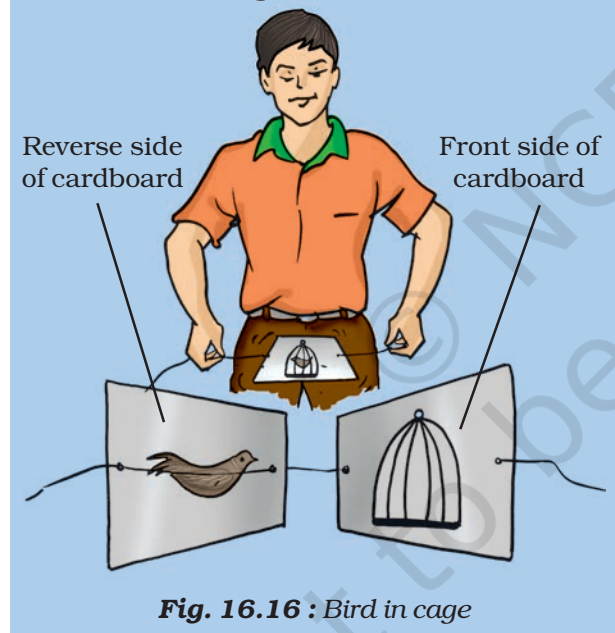

Fig. 16.15 : Demonstration of blind spot

The impression of an image does not vanish immediately from the retina. It persists there for about $1/16$ th of a second. So, if still images of a moving object are flashed on the eye at a rate faster than 16 per second, then the eye perceives this object as moving.

Activity 16.10

Get a square piece of cardboard of size 6-8 cm. Make two holes as shown in Fig. 16.16. Thread a string through the two holes. Draw/paste a cage on one side of the cardboard and a bird on the other side. Twist the string and make the card twirl rapidly. Do you see the bird in the cage?



The movies that we see are actually a number of separate pictures in proper sequence. They are made to move across the eye usually at the rate of 24 pictures per second (faster than 16 per second). So, we see a moving picture.

Nature has provided eyes with eyelids to prevent any object from entering the eye. Eyelids also shut out light when not required.

Eye is such a wonderful instrument that it (normal) can clearly see distant objects as well as objects nearby. The minimum distance at which the eye can see objects distinctly varies with age. The most comfortable distance at which one can read with a normal eye is about 25 cm.

Some persons can see objects close to them clearly but cannot see distant objects so clearly. On the other hand, some persons cannot see objects nearby clearly but they can see distant objects quite well. With suitable corrective lenses, these defects of the eye can be corrected.

Sometimes, particularly in old age, eyesight becomes foggy. It is due to the eye lens becoming cloudy. When it happens, persons are said to have cataract. There is a loss of vision, sometimes extremely severe. It is possible to treat this defect. The opaque lens is removed and a new artificial lens is inserted. Modern technology has made this procedure simpler and safer.

16.8 Care of the Eyes

It is necessary that you take proper care of your eyes. If there is any problem you should go to an eye specialist. Have a regular checkup—

- If advised, use suitable spectacles.
- Too little or too much light is bad for eyes. Insufficient light causes eyestrain and headaches. Too much light, like that of the Sun, a powerful

Did you know?

Animals have eyes shaped in different ways. Eyes of a crab are quite small but they enable the crab to look all around. So, the crab can sense even if the enemy approaches from behind. Butterflies have large eyes that seem to be made up of thousands of little eyes (Fig. 16.17). They can see not only in the front and the sides but the back as well.

A night bird (owl) can see very well in the night but not during the day. On the other hand, day light birds (kite, eagle) can see well during the day but not in the night. The owl has a large cornea and a large pupil to allow more light in its eye. Also, it has on its retina a large number of rods and only a few cones. The day birds on the other hand, have more cones and fewer rods.

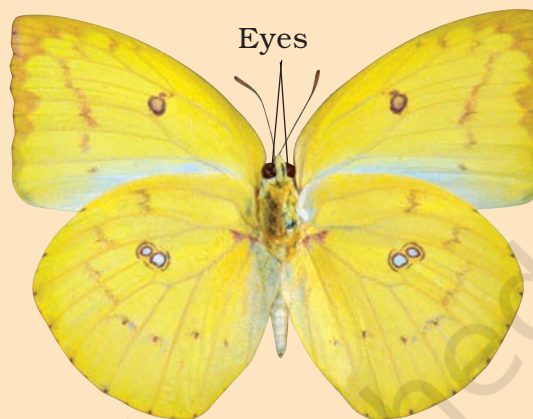

Fig. 16.17 : Eyes of a butterfly

lamp or a laser torch can injure the retina.

- Do not look at the Sun or a powerful light directly.
- Never rub your eyes. If particles of dust go into your eyes, wash your eyes with clean water. If there is no improvement go to a doctor.
- Always read at the normal distance for vision. Do not read by bringing the book too close to your eyes or keeping it too far.

You learnt about balanced diet in Class VI. If food is deficient in some components, eyes may also suffer. Lack of vitamin A in foodstuff is responsible for many eye troubles. Most common amongst them is night blindness.

One should, therefore, include in the diet components which have vitamin A. Raw carrots, broccoli and green

vegetables (such as spinach) and cod liver oil are rich in vitamin A. Eggs, milk, curd, cheese, butter and fruits such as papaya and mango are also rich in vitamin A.

16.9 Visually Impaired Persons Can Read and Write

Some persons, including children, can be visually impaired. They have very limited vision to see things. Some persons cannot see at all since birth. Some persons may lose their eyesight because of a disease or an injury. Such persons try to identify things by touching and listening to voices more carefully. They develop their other senses more sharply. However, additional resources can enable them to develop their capabilities further.

Non-optical and optical aids for visually impaired

Non-optical aids include visual aids, tactual aids (using the sense of touch), auditory aids (using the sense of hearing) and electronic aids. Visual aids, can magnify words, can provide suitable intensity of light and material at proper distances. Tactual aids, including Braille writer slate and stylus, help the visually challenged persons in taking notes, reading and writing. Auditory aids include cassettes, tape recorders, talking books and other such devices. Electronic aids, such as talking calculators and computers, are also available for performing many computational tasks. Closed circuit television, also an electronic aid, enlarges printed material with suitable contrast and illumination. Nowadays, use of audio CDs and voice boxes with computers are also very helpful for listening to and writing the desired text.

Optical aids include bifocal lenses, contact lenses, tinted lenses, magnifiers and telescopic aids. While the lens combinations are used to rectify visual limitations, telescopic aids are available to view chalkboard and class demonstrations.

16.10 What is the Braille System?

The most popular resource for visually challenged persons is **Braille**.

Louis Braille, himself a visually challenged person, developed a system for visually challenged persons and published it in 1821.



Louis Braille

The present system was adopted in 1932. There is Braille code for common languages, mathematics and scientific notation. Many Indian languages can be read using the Braille system.

Braille system has 63 dot patterns or characters. Each character represents a letter, a combination of letters, a common word or a grammatical sign. Dots are arranged in cells of two vertical rows of three dots each.

Patterns of dots to represent some English letters and some common words are shown below.

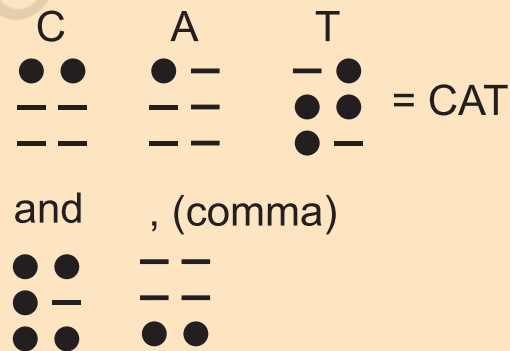

Fig. 16.18 : Example of dot patterns used in Braille System

These patterns when embossed on Braille sheets help visually challenged persons to recognise words by touching. To make them easier to touch, the dots are raised slightly.

Visually impaired people learn the Braille system by beginning with letters, then special characters and letter combinations. Methods depend upon recognition by touching. Each

character has to be memorised. Braille texts can be produced by hand or by machine. Typewriter-like devices and printing machines have now been developed.



Helen A. Keller

Some visually impaired Indians have great achievements to their credit. Diwakar, a child prodigy has given amazing performances as a singer.

Ravindra Jain, born completely visually impaired, obtained his Sangeet Prabhakar degree from Allahabad. He had shown his excellence as a lyricist, singer and music composer.

Lal Advani, himself visually impaired, established an Association for special education and rehabilitation of disabled in India. Besides this, he represented India on Braille problems in UNESCO.

Helen A. Keller, an American author and lecturer, is perhaps the most well-known and inspiring visually challenged person. She lost her sight when she was only 18 months old. But because of her resolve and courage she could complete her graduation from a university. She wrote a number of books including *The Story of my Life* (1903).

KEYWORDS

ANGLE OF
INCIDENCE

ANGLE OF
REFLECTION

BLIND SPOT

BRAILLE

CONES

CORNEA

DIFFUSED OR
IRREGULAR
REFLECTION

INCIDENT RAYS

IRIS

KALEIDOSCOPE

LATERAL INVERSION

LAWS OF
REFLECTION

PUPIL

REFLECTED RAYS

REFLECTION

REGULAR
REFLECTION

RETINA

RODS

WHAT YOU HAVE LEARNT

- Light is reflected from all surfaces.
- Regular reflection takes place when light is incident on smooth, polished and regular surfaces.
- Diffused or irregular reflection takes place from rough surfaces.
- Two laws of reflection are
 - (i) The angle of incidence is equal to the angle of reflection.
 - (ii) Incident ray, reflected ray and the normal drawn at the point of incidence to the reflecting surface, lie in the same plane.
- Image formed in a plane mirror undergoes lateral inversion.
- Two mirrors inclined to each other give multiple images.
- Beautiful patterns are formed in a kaleidoscope because of multiple reflections.
- Sunlight, called white light, consists of seven colours.
- Splitting of light into its constituent colours is known as dispersion.
- Parts of the eye are cornea, iris, pupil, lens, retina and optic nerve.
- A normal eye can see nearby and distant objects clearly.
- Visually impaired persons can read and write using the Braille system.
- Visually impaired persons develop their other senses more sharply to improve their interaction with their environment.

Exercises

1. Suppose you are in a dark room. Can you see objects in the room? Can you see objects outside the room. Explain.
2. Differentiate between regular and diffused reflection. Does diffused reflection mean the failure of the laws of reflection?
3. Mention against each of the following whether regular or diffused reflection will take place when a beam of light strikes. Justify your answer in each case.
 - (a) Polished wooden table
 - (b) Chalk powder
 - (c) Cardboard surface
 - (d) Marble floor with water spread over it
 - (e) Mirror
 - (f) Piece of paper
4. State the laws of reflection.
5. Describe an activity to show that the incident ray, the reflected ray and the normal at the point of incidence lie in the same plane.
6. Fill in the blanks in the following.
 - (a) A person 1 m in front of a plane mirror seems to be _____ m away from his image.
 - (b) If you touch your _____ ear with right hand in front of a plane mirror it will be seen in the mirror that your right ear is touched with _____.
 - (c) The size of the pupil becomes _____ when you see in dim light.
 - (d) Night birds have _____ cones than rods in their eyes.

Choose the correct option in Questions 7 – 8

7. Angle of incidence is equal to the angle of reflection.
 - (a) Always
 - (b) Sometimes
 - (c) Under special conditions
 - (d) Never
8. Image formed by a plane mirror is
 - (a) virtual, behind the mirror and enlarged.
 - (b) virtual, behind the mirror and of the same size as the object.
 - (c) real at the surface of the mirror and enlarged.
 - (d) real, behind the mirror and of the same size as the object.
9. Describe the construction of a kaleidoscope.
10. Draw a labelled sketch of the human eye.

11. Gurmit wanted to perform Activity 16.8 using a laser torch. Her teacher advised her not to do so. Can you explain the basis of the teacher's advise?
12. Explain how you can take care of your eyes.
13. What is the angle of incidence of a ray if the reflected ray is at an angle of 90° to the incident ray?
14. How many images of a candle will be formed if it is placed between two parallel plane mirrors separated by 40 cm?
15. Two mirrors meet at right angles. A ray of light is incident on one at an angle of 30° as shown in Fig. 16.19. Draw the reflected ray from the second mirror.

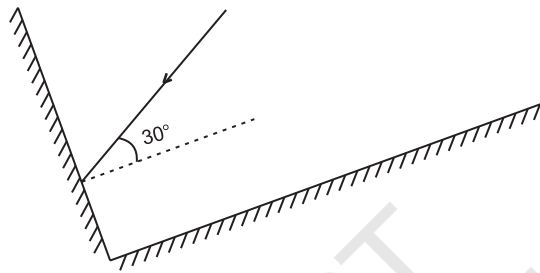

Fig. 16.19

16. Boojho stands at A just on the side of a plane mirror as shown in Fig. 16.20. Can he see himself in the mirror? Also can he see the image of objects situated at P, Q and R?



Fig. 16.20

17. (a) Find out the position of the image of an object situated at A in the plane mirror (Fig. 16.21).
- (b) Can Paheli at B see this image?
- (c) Can Boojho at C see this image?
- (d) When Paheli moves from B to C, where does the image of A move?

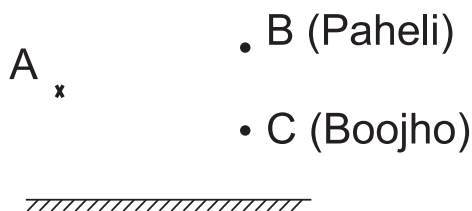

Fig. 16.21

Extended Learning — Activities and Project

1. Make your own mirror. Take a glass strip or glass slab. Clean it and put it on a white sheet of paper. See yourself in the glass. Next put the glass slab on a black sheet of paper. Again look into the glass. In which case do you see yourself better and why?
2. Make friends with some visually impaired students. Enquire from them how they read and write. Also find out how they are able to recognise objects, hurdles and currency notes.
3. Meet an eye specialist. Get your eye sight checked and discuss how to take care of your eyes.
4. Survey your neighbourhood. Find out how many children below the age of 12 years use spectacles. Find out from their parents what, in their view, could be the reason for the weak eyesight of their children.

Did You Know?

Eyes can be donated by any person as an invaluable gift to visually impaired persons suffering from corneal blindness. The person may be

- (a) a male or female.
- (b) of any age.
- (c) of any social status.
- (d) using spectacles.
- (e) suffering from any normal disease but not AIDS, Hepatitis B or C, rabies, leukemia, lymphoma, tetanus, cholera, encephalitis.

The eyes have to be donated within 4-6 hours after death at any place, home or hospital.

A person who wants to donate the eyes may pledge eyes during his/her lifetime to any registered eye bank. He/she should also inform his/her relatives about this pledge so that they can take necessary action after his/her death.

You can also donate a Braille kit.



Paheli and Boojho visited their grandparents' village during the summer break. After dinner, they went on to the roof of the house. It was a clear cloudless night. They were surprised to see a large number of bright stars in the sky. They had never seen such a beautiful scene in their city (Fig. 17.1).

associated with them. Night sky watching can be a fascinating experience at a place where there are no bright lights and the atmosphere is clear.

Look at the sky on a dark, clear night. You see the entire sky dotted with countless stars, some bright and some not so bright. Observe them carefully.



Fig. 17.1: Night sky

Paheli wondered, why the village sky was so different from the night sky in big cities? Her grandfather explained that due to bright light, smoke and dust, the sky in big cities is rarely clear.

He also identified some objects seen in the night sky and told stories

Do all of them appear to twinkle? Do you find any star-like object which does not twinkle? The objects which do not twinkle are planets.

The moon is the brightest object in the night sky. The stars, the planets, the moon and many other objects in the sky are called **celestial objects**.

The study of celestial objects and associated phenomena is called **astronomy**. In ancient India our ancestors performed methodical observations of sky. Their knowledge of astronomy was highly advanced for their time. Passage of the Sun, stars, moon and planets in the sky helped them to devise calendars and almanacs. These were often used by people in their day to day conduct and a better understanding of climate and rainfall patterns for timely sowing and choice of crops, fixing the dates of seasons and festivals.

Let us also make some observations of celestial objects and learn about them.

17.1 The Moon

Activity 17.1

Observe the moon continuously for several nights, preferably from one full moon to the next. Make a sketch of the moon every night in your notebook and note the day from the day of the full moon. Also note everyday the part of the sky (east or west) in which the moon is seen.



Fig.17.2 : Phases of the moon

Is there a change in the shape of the moon everyday? Are there days when the shape of the moon appears to be perfectly round? Are there days when the moon cannot be seen at all even if the sky is clear?

The day on which the whole disc of the moon is visible is known as the full moon day. Thereafter, every night the size of the bright part of the moon appears to become thinner and thinner. On the fifteenth day the moon is not visible. This day is known as the 'new moon day'. The next day, only a small portion of the moon appears in the sky. This is known as the crescent moon. Then again the moon grows larger every day. On the fifteenth day once again we get a full view of the moon.

The various shapes of the bright part of the moon as seen during a month are called **phases of the moon** (Fig. 17.2). Phases of the moon play an important role in our social life. Almost all festivals in India are celebrated according to the phases of the moon. For example, Diwali is celebrated on the new moon day; Budh Purnima and Guru Nanak's birthday are celebrated on full moon day; Maha Shivratri is celebrated on thirteenth night of waning moon; Eid-ul-Fitr is observed on the day following the sighting of crescent moon.

The time period between one full moon to the next full moon is slightly longer than 29 days. In many calendars this period is called a month.



Why does the moon change its shape every day?

Let us try to understand why phases of the moon occur. You have studied in Chapter 16 that the moon does not produce its own light, whereas the Sun and other stars do. We see the moon because the sunlight falling on it gets reflected towards us (Fig. 17.3). We, therefore, see only that part of the moon, from which the light of the Sun is reflected towards us.

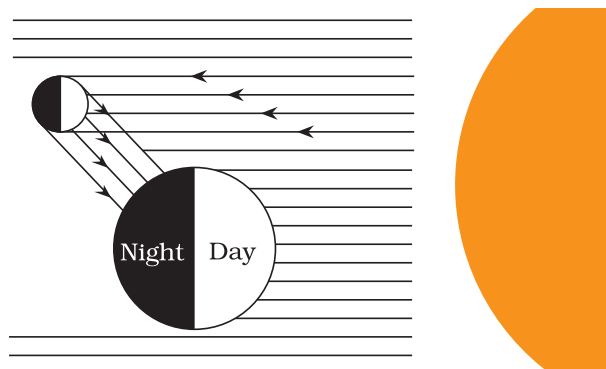

Fig. 17.3 : Moon is visible due to reflected sunlight

Activity 17.2

Take a big ball or a pitcher. Paint half of it white and half black.

Go out into the playground with two of your friends. Draw a circle of radius of about 2 m on the ground. Divide the circle into eight equal parts as shown in Fig. 17.4.

Stand at the centre of the circle. Ask a friend to hold the ball at different points of the circle. Ask her to keep the white portion of the ball always towards the Sun. If you are performing this activity in the morning then the white portion of the ball should be kept towards the east. If the activity is being

performed in the afternoon then the white portion of the ball should be kept towards the west. In each case the line dividing the white and black portions is kept vertical.

Standing at the centre of the circle observe the visible white portion of the ball while your friend stands at the points on the circle marked earlier. Draw the shape of the white portion as you see it. Compare your drawings with the different phases of the moon as shown in Fig. 17.5.



Fig. 17.4: The moon appears different at different positions in its orbit

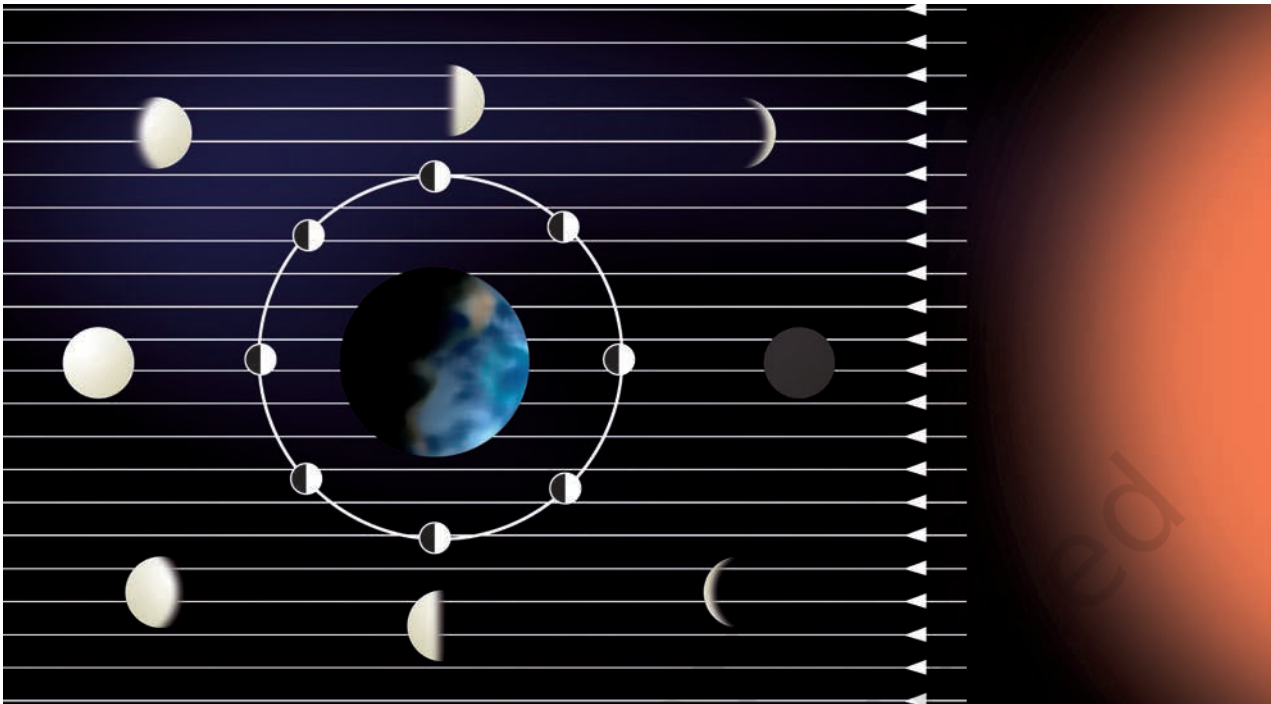

Fig. 17.5: Positions of the moon in its orbit and its corresponding phases

Remember that the moon revolves around the Earth. The Earth along with the moon, revolves around the Sun (Fig. 17.6).

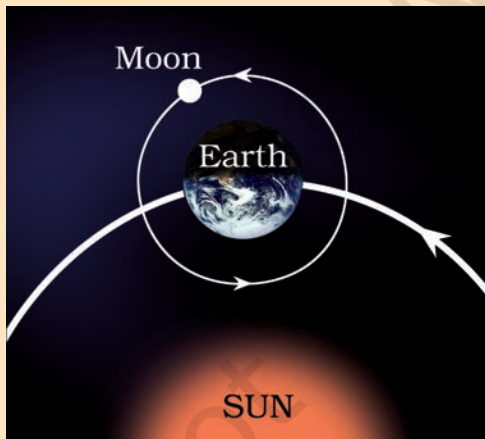

Fig. 17.6 : Earth accompanied by moon revolving around the Sun

Can you now guess the relative positions of the Sun, moon and the Earth on the day of the full moon and on the day of the new moon? Sketch

these positions in your notebook. In which part of the sky would you look for the full moon?

The size of the illuminated part of the moon visible from the Earth increases each day after the new moon day. After the full moon day, the sunlit part of the moon visible from the Earth decreases in size every day.



I have heard that we never see the back side of the moon from the Earth. Is it true?

Activity 17.3

Draw a circle of about 1m diameter on the ground. Ask one of your friends to stand at the centre of this circle. You revolve around your

friend in such a manner that your face always remains towards him. Can your friend see your back? How many rotations did you complete in one revolution? The moon revolves around the Earth in a similar manner.

The moon completes one rotation on its axis as it completes one revolution around the Earth.

The Moon's Surface

The moon is a fascinating object for poets and story-tellers. But when astronauts landed on the moon, they found that the moon's surface is dusty and barren. There are many craters of different sizes. It also has a large number of steep and high mountains (Fig. 17.7). Some of these are as high as the highest mountains on the Earth.



Fig. 17.7 : Surface of the moon

The moon has no atmosphere. It has no water. Can any life exist on the moon?



Can we hear any sound on the moon?



We learnt in Chapter 13 that sound cannot travel when there is no medium. Then, how can we hear any sound on the moon?

Did you know?

On July 21, 1969 (Indian time) the American astronaut, Neil Armstrong, landed on the moon for the first time. He was followed by Edwin Aldrin.

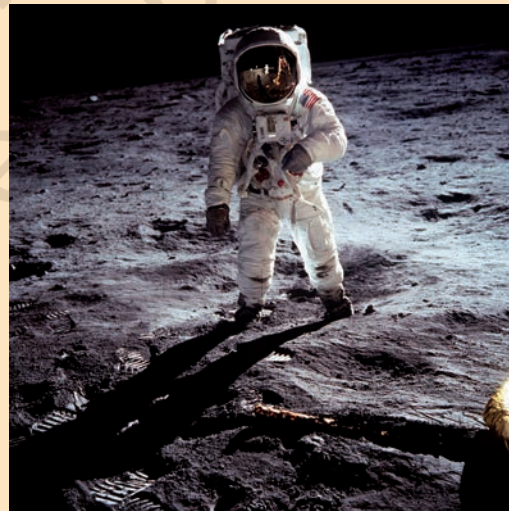

NASA

Fig. 17.8 : An astronaut on the moon

17.2 The Stars

What other objects do you see in the night sky? There is a large number of stars in the sky. Observe carefully on a dark night and from a place away from a big city. Are all the stars equally

bright? Are they of the same colour? In fact, stars emit light of their own. The Sun is also a star. Why does it appear so large compared to the other stars?

Which appears bigger, a football placed near you, or a football placed at a distance of 100 m? The stars are millions of times farther away than the Sun. Therefore, the stars appear to us like points.

The Sun is nearly 150,000,000 kilometres (150 million km) away from the Earth.

The next nearest star is Proxima Centauri. It is at a distance of about 40,000,000,000,000 km from the Earth. Can you read this distance in kilometres conveniently? Some stars are even further away.

Such large distances are expressed in another unit known as **light year**. It is the distance travelled by light in one year. Remember that the speed of light is about 300,000 km per second. Thus, the distance of the Sun from the Earth may be said to be about 8 light minutes. The distance of Alpha Centauri is about 4.3 light years.



If light from stars takes years to reach us, I wonder if we are looking into the past when we look at stars.

I want to know why we do not see the stars during the day. Why are they visible only at night?



In fact, the stars are present in the sky during the day-time also. However, they are not visible then because of the bright sunlight.

Observe some prominent star or a group of stars in the sky for about two hours or more. What do you find? Do you find any change in the positions of stars in the sky?

You will find that the stars appear to move from east to west. A star which rises in the east in the evening, sets in the west in the early morning.

Why do stars appear to move from east to west? Let us find out.

Activity 17.4

Stand in the centre of a big room and start rotating. In which direction will the objects in the room appear to move? Do you see them moving in the direction opposite to your motion?

Paheli recalls that when she is in a moving train the nearby trees and buildings appear to move in the backward direction.

If the stars appear to move from east to west, could it mean that the Earth, rotates from west to east?

Now I understand why the Sun appears to rise in the east and set in the west as the Earth rotates from west to east on its axis.





My grandfather told me that there is one star in the sky which does not move at all. How is it possible?

Activity 17.5

Take an umbrella and open it. Make about 10-15 stars out of white paper. Paste one star at the position of the central rod of the umbrella and others at different places on the cloth near the end of each spoke (Fig. 17.9).



Fig. 17.9 : Pole star does not appear to move

Now rotate the umbrella by holding its central rod in your hand. Observe the stars on the umbrella. Is there any star which does not appear to move? Where is this star located? If there were a star located where the axis of rotation of the Earth meets the sky, could this star also be stationary?

There is actually a star, the pole star, which is situated in the direction of the earth's axis. It does not appear to move (Fig. 17.10).

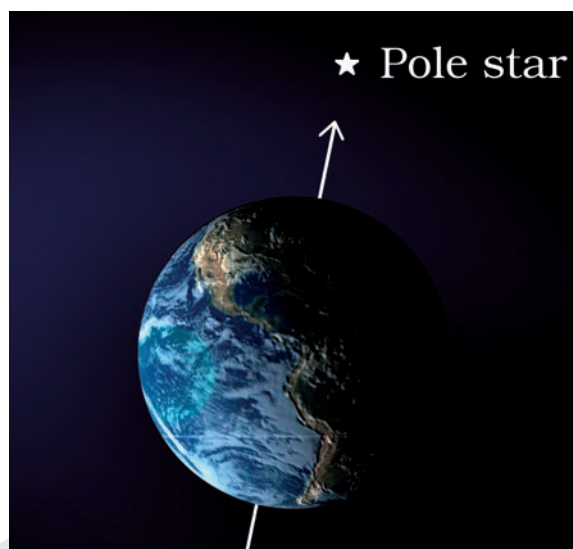

Fig 17.10: The Pole star lies close to the axis of rotation of the Earth

17.3 Constellations

Look at the sky for some time. Can you see some stars forming groups with shapes like those in Fig. 17.11.

The stars forming a group that has a recognisable shape is called a **constellation**.

Constellations were devised by ancient people to be able to recognise stars in the sky. The shapes of constellations resemble objects familiar to those people.

You can easily identify some constellations in the night sky. For this, you should know what a particular constellation looks like and where to look for it in the night sky.

One of the most famous constellations which you can see during

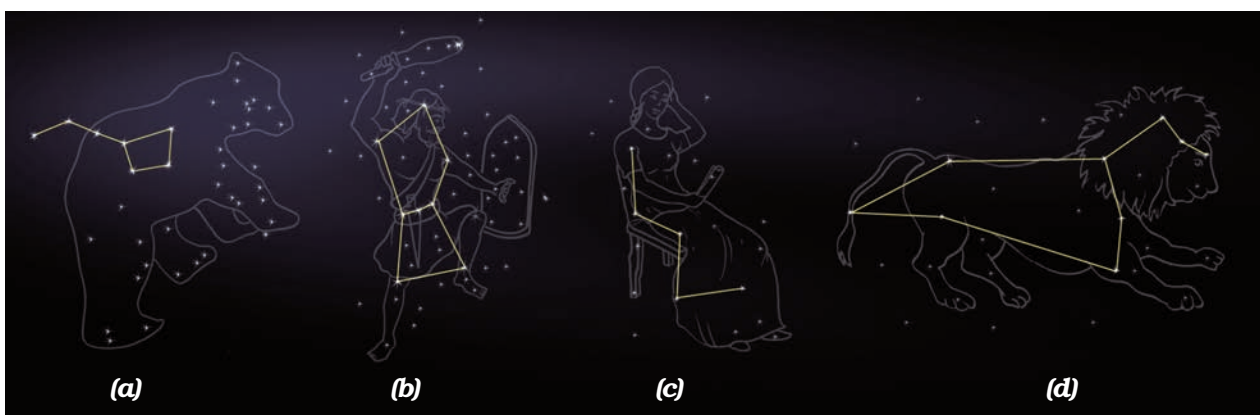

(a) Great Bear

(b) Orion

(c) Cassiopeia

(d) Leo Major

Fig. 17.11 : Some constellations in the night sky

summer time in the early part of the night is **Ursa Major** [Fig. 17.11 (a)].

It is also known as the Big Dipper, the Great Bear or the *Saptarshi*.

There are seven prominent stars in this constellation. It appears like a big ladle or a question mark. There are three stars in the handle of the ladle and four in its bowl (Fig. 17.12).

In all ancient cultures, very interesting mythological stories have been associated with the various constellations.

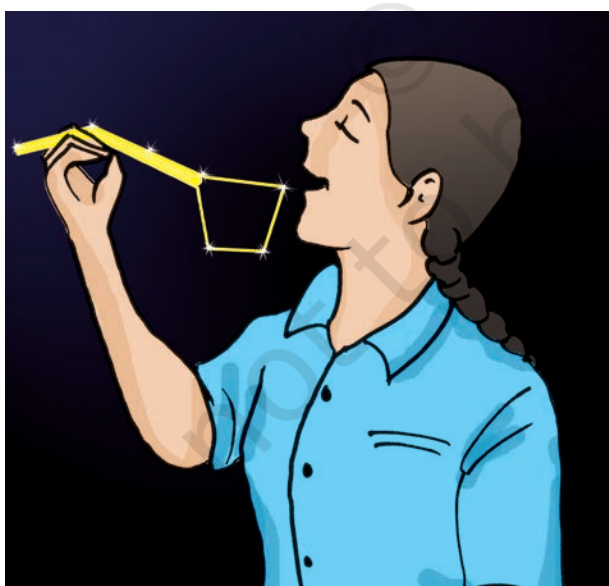
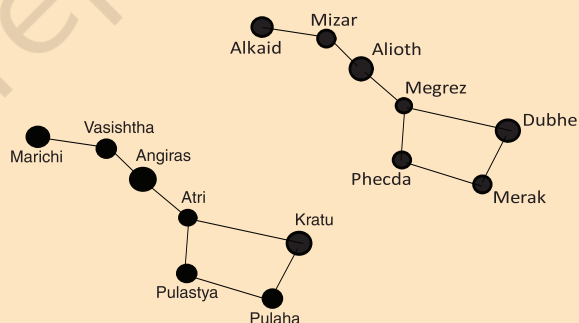

Fig. 17.12: Dipper used for drinking water in ancient times

Ursa Major (*Saptarshi*)

Saptarshi has been associated with seven well known ancient Indian sages, or rishis, as shown in the figure below. According to ancient mythology, the seven sages who form the *Saptarshi*, preserve the eternal knowledge of Vedas and explain it to people in every new age.



Activity 17.6

Observe this constellation for a few hours. Do you find any change in its shape? Do you find any change in its position?

You will observe that the shape of the constellation remains the same.

You will also find that the constellation appears to move in the sky from east to west.



I have heard that we can locate the Pole Star with the help of Ursa Major.

shown in Fig. 17.13. Extend this imaginary line towards the north direction. (*About five times the distance between the two stars.*) This line will lead to a star which is not too bright. This is the Pole star. Observe the Pole star for some time. Note that it does not move at all as other stars drift from east to west.

Activity 17.7

This activity should be performed on a clear moonless night during summer at about 9.00 pm. Look towards the northern part of the sky and identify Ursa Major. You may get help from elders in your family. Look at the two stars at the end of Ursa Major. Imagine a straight line passing through these stars as

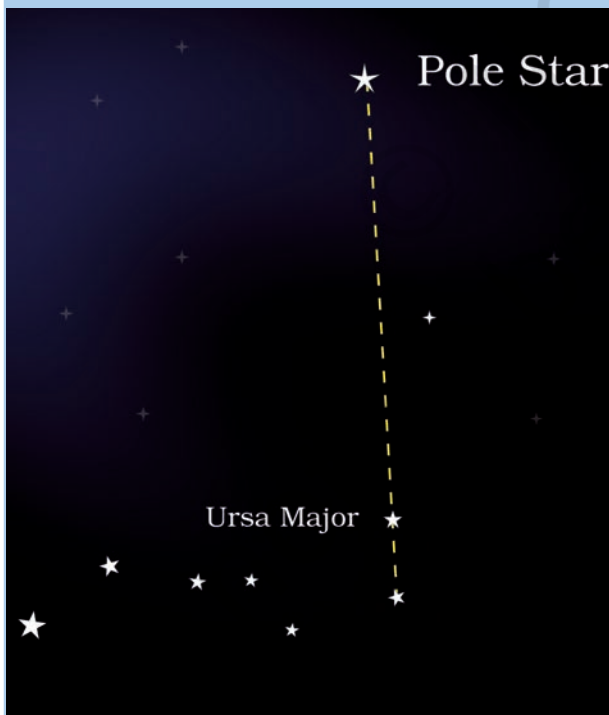

Fig. 17.13: Locating the Pole star

Activity 17.8

During a summer night, observe Ursa Major 3-4 times at an interval of 2 to 3 hours. Also locate the Pole star each time. Does Ursa Major appear to move from east to west? Does it appear to revolve around the Pole star? Compare your observations with those in Fig. 17.14.

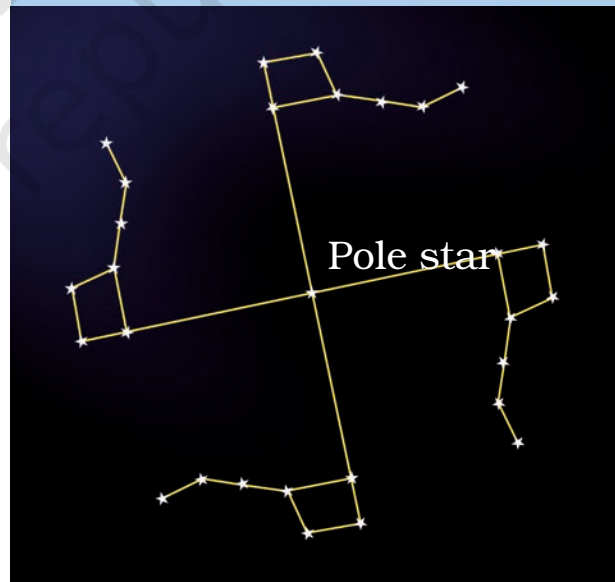

Fig. 17.14: Ursa Major moves around the Pole star

In fact, all the stars appear to revolve around the Pole star.

Note that the Pole star is not visible from the southern hemisphere. Some of the northern constellations like Ursa Major may also not be visible from some points in the southern hemisphere.

Orion is another well-known constellation that can be seen during winter in the late evenings. It is one of the most magnificent constellations in the sky. It also has seven or eight bright stars [Fig. 17.11(b)] Orion is also called the Hunter. The three middle stars represent the belt of the hunter. The four bright stars appear to be arranged in the form of a quadrilateral.

The star Sirius, which is the brightest star in the sky, is located close to Orion. To locate Sirius, imagine a straight line passing through the three middle stars of Orion. Look along this line towards the east. This line will lead you to a very bright star. It is Sirius. (Fig. 17.15).

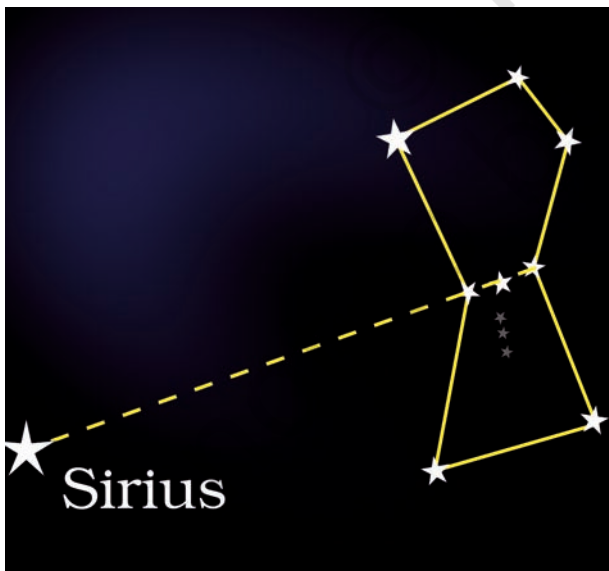

Fig. 17.15: Locating - Sirius

Cassiopeia is another prominent constellation in the northern sky. It is visible during winter in the early part of the night. It looks like a distorted letter W or M [Fig. 17.11(c)].

Did you know?

A constellation does not have only 5-10 stars. It has a large number of stars (Fig. 17.16). However, we can see only the bright stars in a constellation with our naked eye.

All the stars which make up a constellation are not at the same distance. They are just in the same line of sight in the sky.

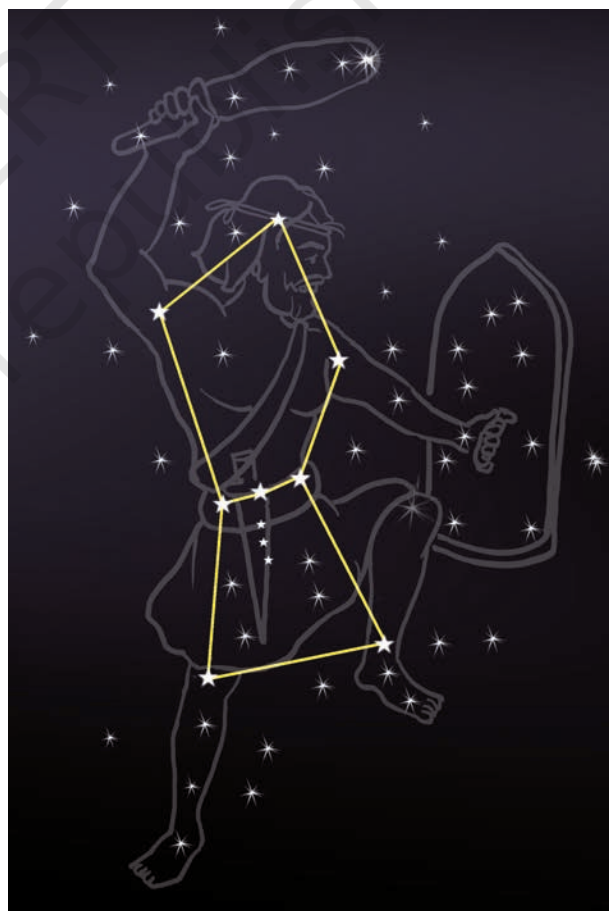

Fig. 17.16

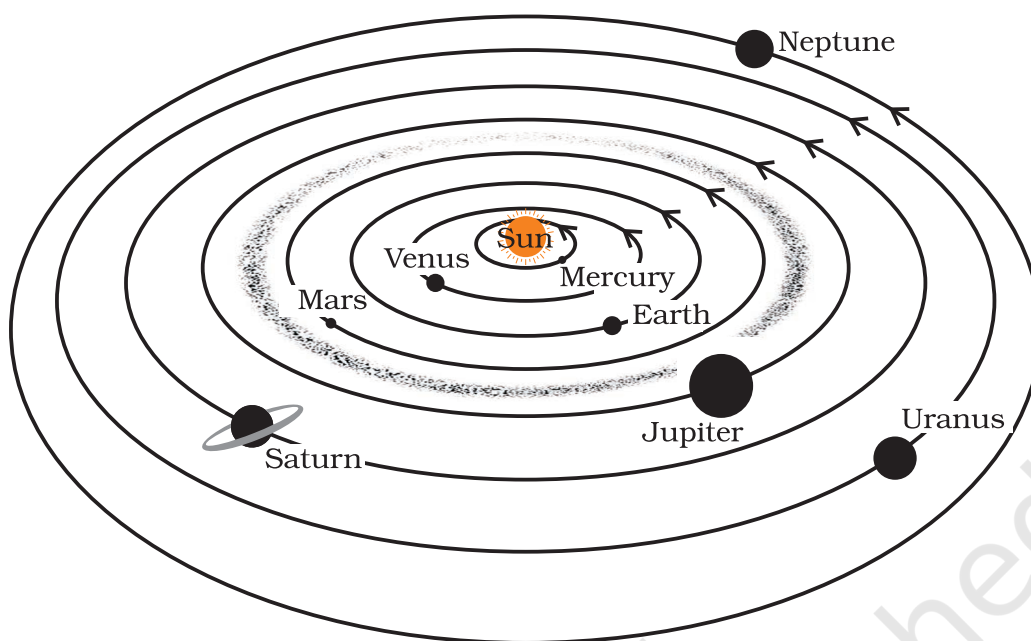

Fig. 17.17 : The solar system (not to scale)

17.4 The Solar System

The Sun and the celestial bodies which revolve around it form the solar system. It consists of large number of bodies such as planets, comets, asteroids and meteors. The gravitational attraction between the Sun and these objects keeps them revolving around it.

The Earth, as you know, also revolves around the Sun. It is a member of the solar system. It is a planet. There are seven other planets that revolve around the Sun. The eight planets in their order of distance from the Sun are: Mercury, Venus, Earth, Mars, Jupiter, Saturn, Uranus and Neptune.

Figure 17.17 shows a schematic view of the solar system.

I have read that there are nine planets in the solar system



Did you know?

Till 2006 there were nine planets in the solar system. Pluto was the farthest planet from the Sun.

In 2006, the International Astronomical Union (IAU) adopted a new definition of a planet. Pluto does not fit this definition. It is no longer a planet of the solar system.

Let us know about some members of the solar family.

The Sun

The Sun is the nearest star from us. It is continuously emitting huge amounts of heat and light. The Sun is the source of almost all energy on the Earth. In fact, the Sun is the main source of heat and light for all the planets.

The Planets

The planets look like stars, but they do not have light of their own. They merely

reflect the sunlight that falls on them. Can you distinguish between planets and stars?

The simplest method of identifying planets from stars is that stars twinkle, whereas planets do not. Also the planets keep changing their positions with respect to the stars.

A planet has a definite path in which it revolves around the Sun. This path is called an **orbit**. The time taken by a planet to complete one revolution is called its period of revolution. The period of revolution increases as the distance of the planet increases from the sun.



I wonder why the planets do not collide while revolving around the Sun.

Activity 17.9

Go out into the playground with four or five of your friends. Draw four circles of radii 1m, 1.8m, 2.5m and 3.8m, all having a common centre (Fig. 17.18).

Ask one of your friends to stand in the centre and represent the Sun. Your other four friends may represent Mercury, Venus, Earth and Mars.

Ask your friends to move around the Sun in anti-clockwise direction in their own orbits (Fig. 17.18). Do they collide with one another?



Fig. 17.18 : Planets move in their own orbits

Besides revolving around the Sun, a planet also rotates on its own axis like a top (Fig. 17.19). The time taken by a planet to complete one rotation is called its period of rotation.



Fig. 17.19 : A Planet rotates on its own axis like a top

Some planets are known to have moons/satellites revolving round them. Any celestial body revolving around another celestial body is called its satellite.

The Earth can be said to be a satellite of the Sun, though generally we call it a



The Earth revolves around the Sun. Does it make Earth a satellite of the Sun?

planet of the Sun. We use the term satellite for the bodies revolving around planets. Moon is a satellite of the Earth.

There are many man-made satellites revolving round the Earth. These are called artificial satellites.

Astronomy in Ancient India

The practice of astronomy in ancient India is mentioned in *Rig Veda* which was composed about 4000 years ago.

Many Indian scholars have contributed to astronomy. One of the most well known astronomers is Aryabhata. The work of Aryabhata on astronomy can be found in his writing '*Aryabhatiya*'. He wrote it in 499 CE at the age of 23 years. The diameter of the Earth as stated by Aryabhata is close to its presently known value. Disregarding the popular view that Earth is '*achala*' (immovable), Aryabhata stated that Earth is sphere and rotates on its own axis. His estimate about the sidereal period of Earth was 23 hours, 56 minutes and 4.1 seconds, which is very close to the presently known value. He also correctly stated that the moon and the planets shine due to reflected sunlight. He also gave a scientific explanation for solar and lunar eclipses. When the shadow of

the Earth falls on the moon, it causes lunar eclipse. When the shadow of the moon falls on the Earth, it causes solar eclipse. Aryabhata also found the distance between the Earth and the moon, which is very close to the known value today.



Aryabhata
C.E. 476 - 550

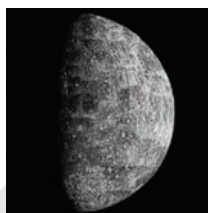

Mercury (Budh)

The planet mercury is nearest to the Sun. It is the smallest planet of our solar system. Because Mercury is very close to the Sun, it is very difficult to observe it, as most of the time it is hidden in the glare of the Sun. However, it can be observed just before sunrise or just after sunset, near the horizon. So it is visible only at places where trees or buildings do not obstruct the view of the horizon. Mercury has no satellite of its own.

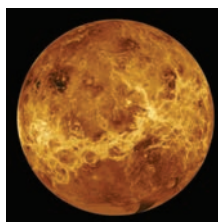

Venus (Shukra)

Venus is earth's nearest planetary neighbour. It is the brightest planet in the night sky.

Sometimes Venus appears in the eastern sky before sunrise. Sometimes it appears in the western sky just after sunset. Therefore it is often called a morning or an evening star, although it is not a star. Try to locate Venus in the night sky.

Venus has no moon or satellite of its own. Rotation of Venus on its axis is somewhat unusual. It rotates from east to west while the Earth rotates from west to east.

Activity 17.10

Find out from some newspaper or from an almanac the time when Venus is visible in the sky. You can easily recognise Venus by its brightness. Remember that Venus cannot be seen very high in the sky. You must try to observe Venus either 1-3 hours before sunrise or 1-3 hours after sunset.

Does it mean that on Venus, the Sun would rise in the west and set in the east?

If you get a chance, try to observe Venus through a telescope. You will observe that Venus shows phases just like the moon (Fig. 17.20).



Fig. 17.20 : Phases of Venus



The Earth (Prithvi)

The Earth is the only planet in the solar system on which life is known to exist. Some special environmental conditions are responsible for the existence and continuation of life on the Earth. These include just the right distance from the Sun, so that it has the right temperature range, the presence of water and suitable atmosphere and a blanket of ozone.



We must take special care to protect our environment so that life on Earth is not disturbed.

From space, the Earth appears blue-green due to the reflection of light from water and landmass on its surface.

The axis of rotation of the Earth is not perpendicular to the plane of its orbit. The tilt is responsible for the change of seasons on the Earth. The Earth has only one moon.



If I am 13 years old, how many times have I gone round the sun?



Mars (Mangal)

The next planet, the first outside the orbit of the Earth is Mars. It appears

slightly reddish and, therefore, it is also called the red planet. Mars has two small natural satellites.

Mangalyaan

Indian Space Research Organisation (ISRO) launched India's first Mars orbiter mission – Mangalyaan, on November 5, 2013. It was successfully placed into an orbit of Mars on September 24, 2014. With this India became the first country in the world to do so in its first attempt.



Jupiter (Brihaspati)

Jupiter is the largest planet of the solar system. It is so large that about 1300 earths can be placed inside this giant planet. However, the mass of Jupiter is about 318 times that of our Earth. It rotates very rapidly on its axis.

Jupiter has a large number of satellites. It also has faint rings around it. You can easily recognise Jupiter as it appears quite bright in the sky. If you observe it with the help of a telescope, you can also see four of its large moons (Fig. 17.22).

You are familiar with the equator of the Earth. The plane of the equator is called the equatorial plane (Fig. 17.21). The plane in which the Earth revolves round the Sun is called the orbital plane of the Earth (Fig. 17.21). These two planes are inclined to each other at an angle of 23.5° . This means that the axis of the Earth is inclined to its orbital plane at an angle of 66.5° .

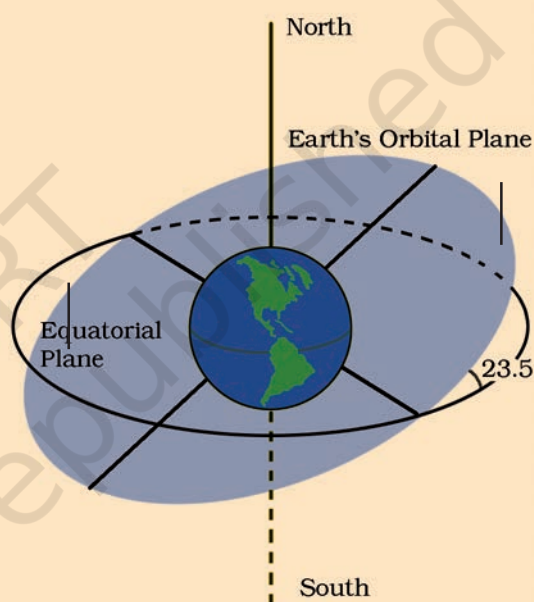

Fig. 17.21 : Earth rotates on a tilted axis

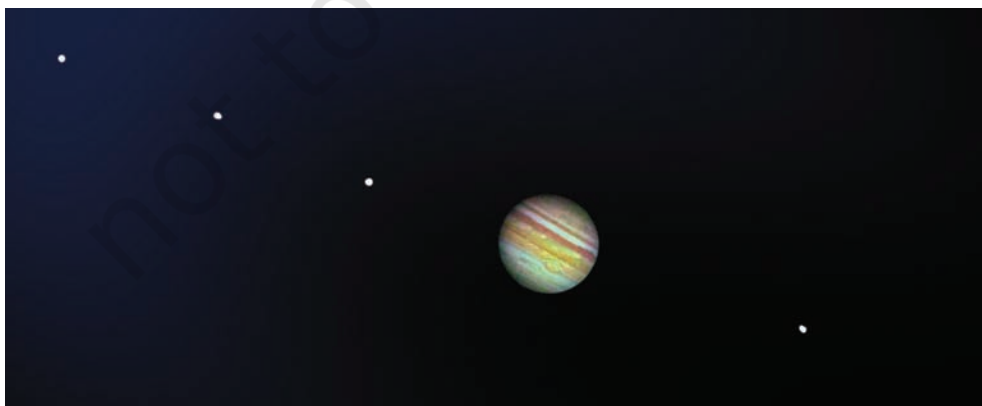

Fig. 17.22 : Jupiter and its four large satellites.

I have an idea! If you take a large ball which can accommodate about 1300 peas, then the ball will represent Jupiter and one pea will represent the Earth.



Saturn (Shani)

Beyond Jupiter is Saturn which appears yellowish in colour. What makes it unique in the solar system is its beautiful rings. These rings are not visible with the naked eye. You can observe them with a small telescope. Saturn also has a large number of satellites.

One interesting thing about Saturn is that it is the least dense among all the planets. Its density is less than that of water.

Uranus and Neptune

These are the outermost planets of the solar system. They can be seen only with the help of large telescopes. Like Venus, Uranus also rotates from east to west. The most remarkable feature of Uranus is that it has highly tilted rotational axis

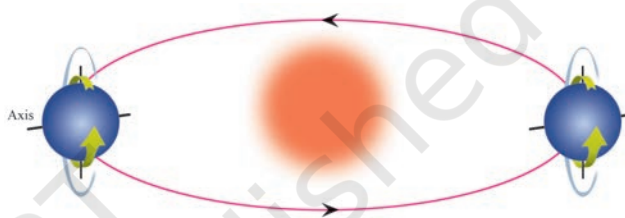
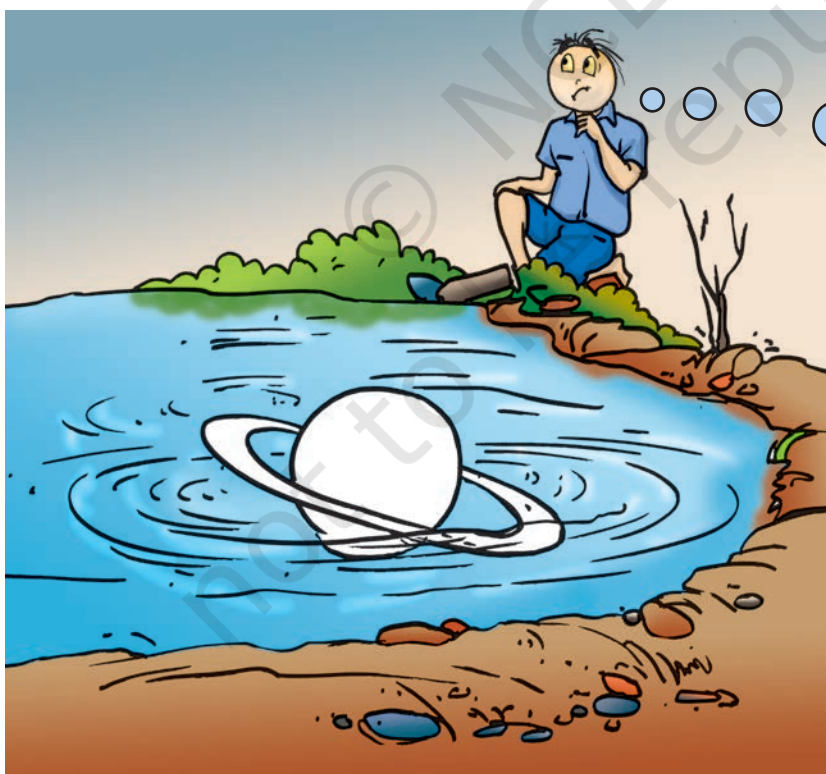

Fig. 17.24 : Uranus in its orbital path



Boojho has a naughty idea! "If we imagine Saturn in a large pool of water then it will float (Fig. 17.23)

Fig. 17.23 : Saturn is less dense than water

(Fig. 17.24). As a result, in its orbital motion it appears to roll on its side.

The first four planets, Mercury, Venus, Earth and Mars are much nearer the Sun than the other four planets. They are called the inner planets. The inner planets have very few moons.

The planets outside the orbit of Mars, namely Jupiter, Saturn, Uranus and Neptune are much farther off than the inner planets. They are called the outer planets. They have a ring system around them. The outer planets have large number of moons.

17.5 Some Other Members of the Solar System

There are some other bodies which revolve around the Sun. They are also members of the solar system. Let us learn about some of them.

Asteroids

There is a large gap in between the orbits of Mars and Jupiter (Fig. 17.25). This gap is occupied by a large number of small objects that revolve around the Sun. These are called **asteroids**. Asteroids can only be seen through large telescopes.

Comets

Comets are also members of our solar system. They revolve around the Sun in highly elliptical orbits. However, their period of revolution round the Sun is usually very long. A Comet appears generally as a bright head with a long tail. The length of the tail grows in size as it approaches the sun. The tail of a comet is always directed away from the sun (Fig. 17.26).

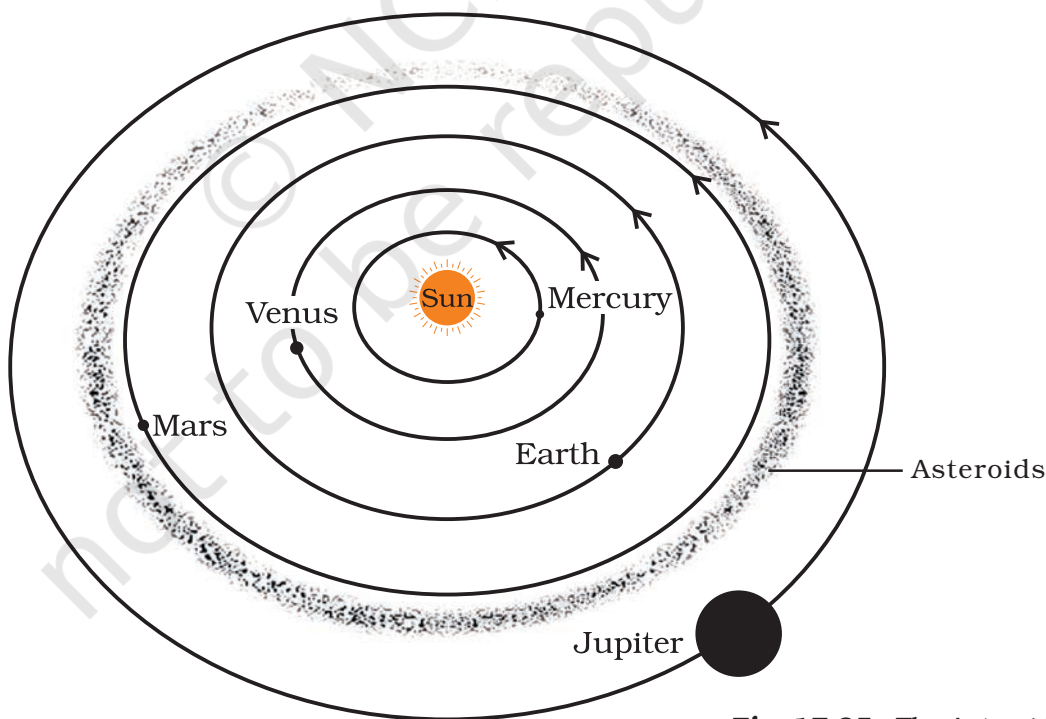

Fig. 17.25 : The Asteroid belt

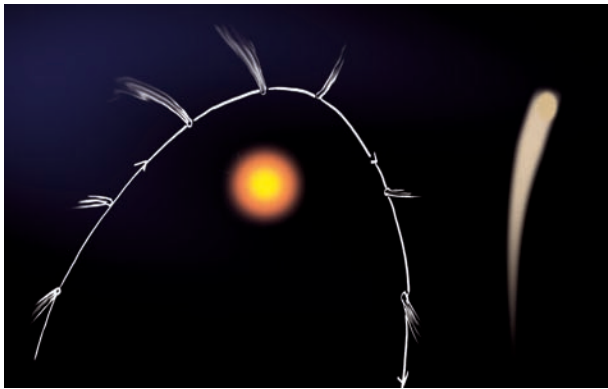

Fig. 17.26 : Different position of a Comet

Many comets are known to appear periodically. One such comet is Halley's comet, which appears after nearly every 76 years. It was last seen in 1986. Can you tell, when Halley's comet will be visible again?

Superstitions about the Comets

Some people think that comets are messengers of disasters, such as wars, epidemics and floods. But these are all myths and superstitions. Appearance of a comet is a natural phenomenon. We have no reason to be afraid of it.

Meteors and Meteorites

At night, when the sky is clear and the moon is not there, you may sometimes see bright streaks of light in the sky (Fig. 17.27). These are commonly known as shooting stars, although they are not stars. They are called **meteors**. A meteor is usually a small object that occasionally enters the earth's atmosphere. At that time it has a very high speed. The friction due to the atmosphere heats it up. It glows and evaporates quickly. That is why the bright streak lasts for a very short time.



Fig. 17.27 : Streak of a Meteor

Some meteors are large and so they can reach the Earth before they evaporate completely. The body that reaches the Earth is called a **meteorite**. Meteorites help scientists in investigating the nature of the material from which the solar system was formed.

Meteor Showers

When the Earth crosses the tail of a comet, swarms of meteors are seen. These are known as meteor showers. Some meteor showers occur at regular intervals each year. You can find the time of their appearance from a scientific magazine or from the internet.

Artificial Satellites

You must have heard that there are a number of artificial satellites which are orbiting the Earth. You might wonder how artificial satellites are different from natural satellites. Artificial satellites are man-made. They are launched from the Earth. They revolve around the Earth much closer than earth's natural satellite, the moon.

India has built and launched several artificial satellites. Aryabhata was the first Indian satellite. Some other Indian satellites are INSAT, IRS, Kalpana-1, EDUSAT, etc. (Fig. 17.28).

Artificial satellites have many practical applications. They are used for forecasting weather, transmitting television and radio signals. They are

also used for telecommunication and remote sensing.



I want to tell you that by remote sensing we mean collecting information from a distance.



ISRO

Fig. 17.28 : Some Indian satellites

KEYWORDS

ARTIFICIAL
SATELLITES

ASTEROIDS

CASSIOPEIA

CELESTIAL OBJECTS

COMETS

CONSTELLATIONS

LIGHT YEAR

METEORITES

METEORS

NATURAL
SATELLITES

ORBIT

ORION

PHASES OF MOON

PLANETS

POLE STAR

REMOTE SENSING

SOLAR SYSTEM

STARS

URSA MAJOR

WHAT YOU HAVE LEARNT

- The phases of the moon occur because we can see only that part of the moon which reflects the light of the Sun towards us.
- Stars are celestial bodies that emit light of their own. Our sun is also a star.
- It is convenient to express distances of stars in light years.
- Stars appear to move from east to west.
- The pole star appears to be stationary from the Earth, because it is situated close to the direction of the axis of rotation of the Earth.
- Constellations are groups of stars that appear to form recognisable shapes.
- The solar system consists of eight planets and a host of asteroids, comets and meteors.
- A body revolving around another body is called a satellite.
- Moon is the natural satellite of the Earth. Some planets also have natural satellites.
- Venus is the brightest planet in the night sky.
- Jupiter is the largest planet of the solar system.
- The artificial satellites revolve around the Earth. They are much closer than the moon.
- Artificial satellites are used for weather forecasting, long distance communication and remote sensing.

Exercises

Choose the correct answer in Questions 1-3.

1. Which of the following is NOT a member of the solar system?
(a) An asteroid (b) A satellite
(c) A constellation (d) A comet
2. Which of the following is NOT a planet of the sun?
(a) Sirius (b) Mercury
(c) Saturn (d) Earth

3. Phases of the moon occur because
- we can see only that part of the moon which reflects light towards us.
 - our distance from the moon keeps changing.
 - the shadow of the Earth covers only a part of the moon's surface.
 - the thickness of the moon's atmosphere is not constant.
4. Fill in the blanks.
- The planet which is farthest from the Sun is _____ .
 - The planet which appears reddish in colour is _____ .
 - A group of stars that appear to form a pattern in the sky is known as a _____ .
 - A celestial body that revolves around a planet is known as _____.
 - Shooting stars are actually not _____.
 - Asteroids are found between the orbits of _____ and _____ .
5. Mark the following statements as true (T) or false (F).
- Pole star is a member of the solar system. ()
 - Mercury is the smallest planet of the solar system. ()
 - Uranus is the farthest planet in the solar system. ()
 - INSAT is an artificial satellite. ()
 - There are nine planets in the solar system. ()
 - Constellation Orion can be seen only with a telescope. ()
6. Match items in column **A** with one or more items in column **B**.
- | A | B |
|-----------------------------|----------------|
| (i) Inner planets | (a) Saturn |
| (ii) Outer planets | (b) Pole star |
| (iii) Constellation | (c) Great Bear |
| (iv) Satellite of the Earth | (d) Moon |
| | (e) Earth |
| | (f) Orion |
| | (g) Mars |
7. In which part of the sky can you find Venus if it is visible as an evening star?
8. Name the largest planet of the solar system.
9. What is a constellation? Name any two constellations.
10. Draw sketches to show the relative positions of prominent stars in
(a) Ursa Major and (b) Orion
11. Name two objects other than planets which are members of the solar system.
12. Explain how you can locate the Pole Star with the help of Ursa Major.
13. Do all the stars in the sky move? Explain.
14. Why is the distance between stars expressed in light years? What do you understand by the statement that a star is eight light years away from the Earth?

15. The radius of Jupiter is 11 times the radius of the Earth. Calculate the ratio of the volumes of Jupiter and the Earth. How many Earths can Jupiter accommodate?
16. Boojho made the following sketch (Fig. 17.29) of the solar system. Is the sketch correct? If not, correct it.

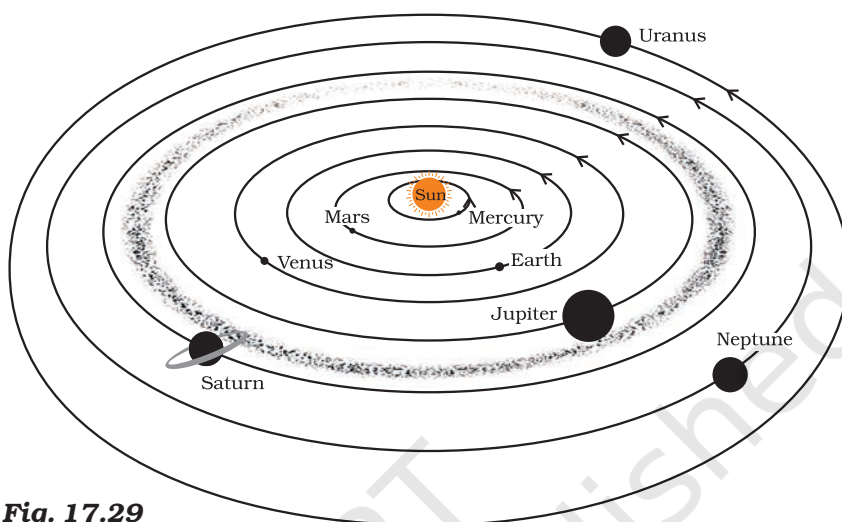
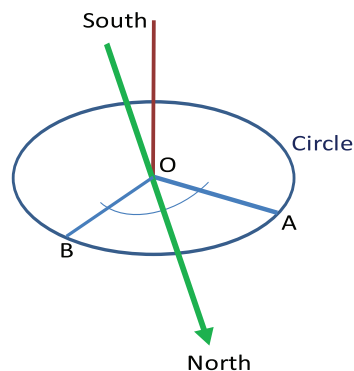

Fig. 17.29

Extended Learning — Activities and Projects

1. The North-South line at your place

Let us learn to draw the north-south line with the help of the shadow of a stick. Fix a straight stick vertically in the ground where the Sun can be seen for most of the day. Call the foot of the stick as point O. Sometime in the morning, mark the tip of the shadow of the stick. Say this point is A. With OA as radius draw a circle on the ground. Wait till the shadow becomes shorter and then starts increasing in size. When the shadow again touches the circle, mark it as point B. Draw the bisector of the angle AOB. This is your North-South line.



To decide which side of this line shows North, use a magnetic compass.

2. If possible, visit a planetarium. There are planetariums in many cities. In a planetarium you can see the motion of the stars, constellations and planets on a large dome.
3. On a moonless night observe the sky for a few hours. Look out for a meteor, which appears as a streak of light. September-November is a good time for observing meteors.

4. Learn to identify the planets visible to the naked eye and some prominent constellations such as Great Bear (Saptarshi) and Orion. Also try to locate the Pole Star and the star Sirius.
5. *Position of the rising Sun – Uttarayan and Dakshinayan:*
This activity may last for several weeks. Choose a place from where eastern horizon is clearly visible. Choose also a marker, such as a tree or an electric pole, to mark the position of the rising Sun. It will be sufficient if you take the observation once every week. On any day, note down the direction of the rising Sun. Repeat this observation every week. What do you find? You would have noted that the point of sunrise changes continuously. From **summer solstice** (around 21 June), the point of sunrise gradually shifts towards the south. The Sun is then said to be in **dakshinayan** (moving south). It keeps doing so till **winter solstice** (around 22 December). Thereafter, the point of sunrise changes direction and starts moving towards north. The Sun is now said to be in **uttarayan** (moving north). From the equator, only on two days, on the days of the **equinoxes** (around 21 March and 23 September) the Sun rises in the east. On all other days, it rises either north of east or south of east. So, the direction of the rising Sun is not a good guide to determine directions. The Pole Star, which defines North, is a much better indicator of directions.
6. Form a group of students. Prepare a model of the solar system showing the planets, and their relative sizes. For this take a large chart paper. Make spheres representing different planets according to their relative size (Use Table 17.1). You may use newspaper, clay

Table 17.1

Name of Planet	Approximate radius (assuming Earth as 1 unit)	Approximate distance from the Sun (assuming distance of the Earth as 1 unit)	Period of revolution	Period of rotation
Mercury	0.40	0.39	88 days	59 days
Venus	0.95	0.72	225 days	243 days
Earth	1.00	1.00	365.25 days	24 hours
Mars	0.55	1.50	687 days	24 hours 37 min
Jupiter	11.00	5.20	12 years	9 hours 55 min
Saturn	9.00	9.50	29.46 years	10.66 hours
Uranus	4.00	19.20	84 years	17.2 hours
Neptune	3.90	30.00	165 years	16.1 hours

or plasticine to make spheres. You can cover these spheres with paper of different colours. Exhibit your models in the class.

7. Try to make a **scale model** of the solar system showing distances of the planets from the Sun (Use Table 17.1). Did you face any difficulty? Explain it.

8. Solve the following riddle and try to make similar riddles yourself:

My first is in VAN but not in PAN

My second is in EARTH and also in HEAVEN

My third is in ONE and not in TWO

My fourth is in BUN and also in FUN

My last is in STAR but not in RADAR

I am a planet that moves round the Sun.

You can read more on the following websites :

- <http://www.nineplanets.org>
- <http://www.kidsastronomy.com>

Did You Know ?

In ancient times, it was believed that the Earth was at the centre of the universe and the moon, the planets, the Sun and stars were orbiting around it. About 500 years ago, a Polish priest and astronomer, named Nicolaus Copernicus (1473 – 1543), stated that the Sun was at the centre of the solar system and the planets revolved around it. It was a revolutionary idea. Even Copernicus hesitated to publish his work. His work was published in the year of his death in 1543.

In 1609, Galileo designed his own telescope. Through this telescope Galileo observed moons of Jupiter, phases of Venus and rings of Saturn. He argued that all the planets must orbit the Sun and not the Earth.

Thus you can see that ideas and concepts grow and change. How about your own ideas? Do you keep your mind open to accept new ideas when there is good evidence to support it?

Kalpana Chawla: The First Indian Woman in Space

Kalpana Chawla is the first Indian woman astronaut. She was born on 17 March 1962 in Karnal, Haryana. She did her Bachelor of Science degree in Aeronautical Engineering from Punjab Engineering College, Chandigarh. In 1982, she moved to USA and obtained a Master of Science degree in Aerospace Engineering from the University of Texas and Ph.D. in Aerospace Engineering from University of Colorado. In 1988, she started working in NASA and was selected for her first flight in 1996. She was the



first Indian-born woman and the second Indian person to fly in space. Unfortunately she was one of the seven astronauts who lost their lives in Space Shuttle Columbia disaster on 1 February 2003. She is a role model for many young women around the world.



Paheli and Boojho were very excited to know that Taj Mahal in Agra is one of the seven wonders of the world. But they were disappointed to hear that the beauty of this monument in white marble is being threatened by air pollution in the area surrounding the Taj. They were eager to know if something can be done to control the air and water pollution.

We are all aware that our environment is not what it used to be. Our elders talk about the clean water and fresh air that was available in their times. Now the media regularly reports on the falling quality of the environment. We ourselves feel the impact of the falling quality of air and water in our lives. The number of people suffering from diseases of the respiratory system, for example, is steadily rising.

We shudder to imagine a time when clean air and water may no longer be available! You have learnt about the importance of air and water in your previous classes. In this chapter, we will study about the harmful changes taking place in our surroundings and their effects on our lives.

18.1 Air Pollution

We can survive for some time without food, but we cannot survive even for a few minutes without air. This simple fact tells us how important clean air is to us.

You already know that air consists of a mixture of gases. By volume, about 78% of this mixture is nitrogen and about 21% is oxygen. Carbon dioxide, argon, methane, ozone and water vapour are also present in very small quantities.

Activity 18.1

You may have covered your nose while passing a brick kiln emitting smoke or started coughing while walking on a busy road (Fig. 18.1). On the basis of your experience, compare the quality of air at the places given below:

- A park and a busy road.
- A residential area and an industrial area.
- A busy traffic intersection at different times of the day e.g. early morning, afternoon and evening.
- A village and a town.



Fig. 18.1 : A congested road in a city

One of your observations in the above activity could be the differences in the amount of smoke in the atmosphere. Do you know where the smoke could have come from? Addition of such substances to the atmosphere modifies it. When air is contaminated by unwanted substances which have a harmful effect on both the living and the non-living, it is referred to as **air pollution**.

18.2 How does Air Get Polluted?

The substances which contaminate the air are called **air pollutants**. Sometimes, such substances may come from natural sources like smoke and dust arising from forest fires or volcanic eruptions. Pollutants are also added to the atmosphere by certain human activities. The sources of air pollutants are factories (Fig. 18.2), power plants, automobile exhausts and burning of firewood and dung cakes.



Fig. 18.2 : Smoke from a factory

Activity 18.2

You might have read in the newspapers that respiratory problems amongst children are rising day by day. Conduct a survey of households in your neighbourhood and among friends to find out how many children are suffering from respiratory problems.

Many respiratory problems are caused by air pollution. Let us now try to find out the substances or pollutants which are present in the polluted air.

Have you noticed how rapidly the number of vehicles is increasing in our cities?

Vehicles produce high levels of pollutants like carbon monoxide, carbon dioxide, nitrogen oxides and smoke (Fig. 18.3). Carbon monoxide is produced from incomplete burning of fuels such as petrol and diesel. It is a poisonous gas. It reduces the oxygen-carrying capacity of the blood.



Fig. 18.3 : Air pollution due to automobiles

Do you know?

If the vehicles registered in Delhi are lined up one after the other, the total length would be nearly equal to the combined lengths of the two longest rivers in the world, Nile and Amazon!

Boojho remembers seeing a thick fog-like layer in the atmosphere, especially during winters. This is **smog** which is made up of smoke and fog. Smoke may contain oxides of nitrogen which combine with other air pollutants and fog to form smog. The smog causes breathing difficulties such as asthma, cough and wheezing in children.

Many industries are also responsible for causing air pollution. Petroleum refineries are a major source of gaseous pollutants like sulphur dioxide and nitrogen dioxide. Sulphur dioxide is produced by combustion of fuels like coal in power plants. It can cause respiratory problems, including permanent lung damage. You have already studied about the burning of fossil fuels in Chapter 5.

Other kinds of pollutants are **chlorofluorocarbons** (CFCs) which are used in refrigerators, air conditioners and aerosol sprays. CFCs damage the ozone layer of the atmosphere. Recall that the ozone layer protects us from harmful ultraviolet rays of the sun. Have you heard of the ozone hole? Try to find out about it. Thankfully, less harmful chemicals are now being used in place of CFCs.

In addition to the above mentioned gases, automobiles which burn diesel and petrol, also produce tiny particles which remain suspended in air for long periods (Fig. 18.3). They reduce visibility. When inhaled, they cause diseases. Such particles are also produced during industrial processes like steel making and mining. Power plants give out tiny ash particles which also pollute the atmosphere.

Activity 18.3

Prepare a table using the pollutants mentioned above. You may even add more data to the following Table.

Table 18.1

Air Pollutants	Sources	Effects

18.3 Case Study— The Taj Mahal

Over the past 2 decades, India's most famous tourist attraction, Taj Mahal located in Agra (Fig. 18.4), has become a matter of concern. Experts have warned that pollutants in air are discolouring its white marble. So, it is not only living organisms that get affected by polluted air but non-living things like buildings, monuments and statues also get affected.

The industries located in and around Agra like rubber processing, automobile, chemicals and especially the Mathura oil refinery, have been responsible for producing pollutants like sulphur dioxide and nitrogen dioxide. These gases react with the water vapour present in the atmosphere to form sulphuric acid and nitric acid. The acids drop down with rain, making the rain acidic. This is called acid rain. Acid rain corrodes the marble of the monument. The phenomenon is also called "Marble cancer". Suspended particulate matter, such as the soot particles emitted by Mathura oil refinery, has contributed towards the yellowing of the marble.

The Supreme Court has taken several steps to save the Taj. It has



Fig. 18.4 : Taj Mahal

ordered industries to switch to cleaner fuels like CNG (Compressed Natural Gas) and LPG (Liquefied Petroleum Gas). Moreover, the automobiles should switch over to unleaded petrol in the Taj zone.

Discuss with your elders and see what they have to say about the condition of the Taj, 20 or 30 years ago! Try to procure a picture of the Taj Mahal for your scrap book.



I am reminded of the chapter on crops. I wonder whether acid rain affects the soil and plants also.

18.4 Greenhouse Effect

You know that the sun's rays warm the earth's surface. A part of the radiation that falls on the earth is absorbed by it

and a part is reflected back into space. A part of the reflected radiation is trapped by the atmosphere. The trapped radiations further warm the earth. If you have seen a greenhouse in a nursery or elsewhere, recall that the sun's heat is allowed to get in but is not allowed to go out. The trapped heat warms the green house. The trapping of radiations by the earth's atmosphere is similar. That is why it is called the **greenhouse effect**. Without this process, life would not have been possible on the earth. But now it threatens life. Excess of CO_2 in the air is one of the gases responsible for this effect.

You know that CO_2 is one of the components of air. You have also studied



But how does CO_2 content rise in the atmosphere and become excessive?

the role of carbon dioxide in plants. But if there is excess of CO_2 in the air, it acts as a pollutant.

Can you help Paheli find out the answer to her question?

On the one hand, CO_2 is continuously being released because of human activities. On the other hand, area under forests is decreasing. Plants utilise CO_2 from the atmosphere for photosynthesis, thereby decreasing the amount of CO_2 in the air. Deforestation leads to an increase in the amount of CO_2 in the air because the number of trees which consume CO_2 is reduced. Human activities, thus, contribute to the accumulation of CO_2 in the atmosphere. CO_2 traps heat and does not allow it to escape into space. As a result, the average temperature of the earth's atmosphere is gradually increasing. This is called **global warming**.

Other gases like methane, nitrous oxide and water vapour also contribute

towards this effect. Like CO_2 , they are also called **greenhouse gases**.

Global warming has become a major concern for governments worldwide. Many countries have reached an agreement to reduce the emission of greenhouse gases. The Kyoto Protocol is one such agreement.

Boojho is surprised to hear that an increase in the earth's temperature by even as little as 0.5°C can have such a serious effect! Paheli tells him that she had read in the newspapers recently that the Gangotri glacier in the Himalayas has started melting because of global warming.

18.5 What can be Done?

What can we do to reduce air pollution?

There are many success stories in our fight against air pollution. For example, a few years ago, Delhi was one of the most polluted cities in the world. It was being choked by fumes released from automobiles running on diesel and petrol. A decision was taken to switch to fuels like CNG (Fig. 18.5) and

Global Warming

A Serious Threat!

Global warming can cause sea levels to rise dramatically. In many places, coastal areas have already been flooded. Global warming could result in wide ranging effects on rainfall patterns, agriculture, forests, plants and animals. Majority of people living in regions which are threatened by global warming are in Asia. A recent climate change report gives us only a limited time to keep the greenhouse gases at the present level. Otherwise, the temperature may rise by more than 2 degrees Celsius by the end of the century, a level considered dangerous.



Fig. 18.5 : A public transport bus powered by CNG

unleaded petrol. These measures have resulted in cleaner air for the city. You might know of some other examples from your area regarding reduction of air pollution. Share these with your friends.

Do you know about the “Say no to crackers” campaign which was organised by children from many schools? This made a big difference to the air pollution levels around Diwali.

The quality of air at various locations is monitored regularly by government and other agencies. We can use this data to generate awareness about air pollution among friends and neighbours.

There is a need to switch over to alternative fuels instead of the fossil

fuels for our energy requirements. These could be solar energy, hydropower and wind energy.

Activity 18.4

You have various options of commuting to your school such as walking, going by bicycle, travelling by bus or other public transport, using a car individually, travelling by car pool. Discuss in your class the impact of each of these options on the quality of air.

Small contributions on our part can make a huge difference in the state of the environment. We can plant trees and nurture the ones already present in the neighbourhood. Do you know about *Van Mahotsav*, when lakhs of trees are planted in July every year (Fig. 18.6)?



Fig. 18.6 : Children planting saplings

Boojho and Paheli once happened to go to an area where some people were burning dry leaves. They started coughing because the entire area was full of smoke. Paheli thought it would be a better option to put them in a compost pit rather than burning. What do you think?

18.6 Water Pollution

In Class VII you learnt that water is a precious resource. Think and list the various activities in which we need water. We saw that water is becoming scarce due to increase in population, industries and agricultural activities. You have also studied how water becomes “dirty” after we use it for washing clothes, bathing, etc. This means that we are adding some materials to the water, which spoil its quality and change its smell and colour.

Whenever harmful substances such as sewage, toxic chemicals, silt, etc., get mixed with water, the water becomes polluted. The substances that pollute water are called **water pollutants**.

Activity 18.5

Try to collect samples of water from a tap, pond, river, well and lake. Pour each into separate glass containers. Compare these for smell, acidity and colour. Complete the following Table.

Table 18.2

	Smell	Acidity	Colour
Tap Water			
Pond Water			
River Water			
Well Water			
Lake Water			

18.7 How does Water Get Polluted?

Case Study

Ganga is one of the most famous rivers of India (Fig. 18.7). It sustains most of the northern, central and eastern Indian population. Millions of people depend on it for their daily needs and



Fig. 18.7 : Course of the river Ganga

livelihood. However, recently a study by the World Wide Fund for Nature (WWF) found that Ganga is one of the ten most endangered rivers in the world. The pollution levels have been rising for many years. We have reached this stage because the towns and cities, through which the river flows, throw large quantities of garbage, untreated sewage, dead bodies, and many other harmful things, directly into the river. In fact the river is 'dead' at many places where the pollution levels are so high that aquatic life cannot survive.

An ambitious plan to save the river, called the **Ganga Action Plan** was launched in 1985. It aimed to reduce the pollution levels in the river. However, the increasing population and industrialisation have already damaged this mighty river beyond repair. Now, the Government of India has launched a new initiative known as National Mission for Clean Ganga (NMCG) in 2016.

Let us take a specific example to understand the situation. The Ganga at Kanpur in Uttar Pradesh (U.P.), has one of the most polluted stretches of the river (Fig. 18.8). Kanpur is one of the most populated towns in U.P.



Fig. 18.8 : A polluted stretch of the river Ganga

People can be seen bathing, washing clothes and defecating in the river. They also throw garbage, flowers, idols of gods and goddesses and non-biodegradable polythene bags into the river.

At Kanpur the amount of water is comparatively small and the flow of the river is very slow. In addition, Kanpur has more than 5000 industries. These include fertiliser, detergent, leather and paint industries. These industrial units discharge toxic chemical wastes into the river.

Based on the above information think of the answers to the following questions –

- What are the factors responsible for pollution of the river ?
- What steps can be taken to restore the river Ganga to its past glory ?
- How would the disposal of garbage, etc., affect the living organisms in the river ?

Many industries discharge harmful chemicals into rivers and streams, causing the pollution of water (Fig. 18.9). Examples are oil refineries, paper factories, textile and sugar mills



Fig. 18.9 : Industrial waste discharged into a river

and chemical factories. These industries cause chemical contamination of water. The chemicals released include arsenic, lead and fluorides which lead to toxicity in plants and animals. There are regulations to prevent this. Industries are supposed to treat the waste produced before discharging it into waters, but quite often the rules are not followed. The soil is also affected by impure water, causing changes in acidity, growth of worms, etc.

We have learnt in Chapter 1 the importance of pesticides and weedicides for the protection of crops. However, all these chemicals dissolve in water and are washed into water bodies from the fields. They also seep into the ground to pollute ground water.

Have you seen ponds which look green from a distance because they have a lot of algae growing in them? This is caused by excessive quantities of chemicals which get washed from the fields. These act as nutrients for algae to flourish. Once these algae die, they serve as food for decomposers like bacteria. A lot of oxygen in the water body gets used up. This results in a decrease in the oxygen level which may kill aquatic organisms.

Recall Activity 18.6

You had investigated the sewage disposal system of your locality in Class VII.

Do you remember how the sewage was collected from your home and where it went thereafter?

Sometimes untreated sewage is thrown directly into rivers. It contains

food wastes, detergents, microorganisms, etc. Can ground water get polluted by sewage? How? Water contaminated with sewage may contain bacteria, viruses, fungi and parasites which cause diseases like cholera, typhoid and jaundice.

The bacteria present in the faeces of mammals are indicators of the quality of water. If water has these bacteria, it means that it has been contaminated by fecal matter. If such water is used by us, it can cause various infections.

Do you know?

Hot water can also be a pollutant ! This is usually water from power plants and industries. It is released into the rivers. It raises the temperature of the waterbody, adversely affecting the animals and plants living in it.

18.8 What is Potable Water and How is Water Purified ?

Activity 18.7

Let us construct a water filter with simple, everyday materials.

Take a plastic bottle and cut it into 2 halves at the centre. Use the upper half as a funnel by putting it upside down in the lower half. Make layers in it with paper napkin or a fine cloth followed by, cotton, sand and then gravel. Now pour dirty water through the filter and observe the filtered water.

Discuss the following questions amongst yourselves and with your teacher:

- Why do we need to filter water before drinking ?
- Where do you get your drinking water from?
- What will happen if we drink polluted water?

Boojho is very upset. He tells Paheli that he drank water which looked clear and was without any smell, but still he fell sick !

Paheli explains that water which looks clean may still have disease-carrying microorganisms and dissolved impurities. So, it is essential to purify water before drinking, for example, by boiling.

Water which is suitable for drinking is called **potable water**. You have seen how various physical and chemical processes in the sewage treatment plants help to clean water before discharging it into water bodies. Similarly, municipal bodies treat the water before supplying it to households.

Do you know?

25% of the world's population is without safe drinking water !

Let us see how water can be made safe for drinking:

- You have already seen how water is filtered. This is a physical method of removing impurities. A popular household filter is a candle type filter.
- Many households use boiling as a method for obtaining safe drinking

water. Boiling kills the germs present in the water.

- Chlorination is a commonly used chemical method for purifying water. It is done by adding chlorine tablets or bleaching powder to the water. **We must be cautious. We should not use more chlorine tablets than specified.**

18.9 What Can be Done?

Activity 18.8

Investigate the level of awareness about water pollution in your area. Collect data on the sources of drinking water and the methods of sewage disposal.

What are the common water-borne diseases in the community? You can consult your local doctor/health worker for this.

Which are the governmental and non-governmental organisations working in this field? What are the measures being taken by them for generating awareness?

Laws for industrial units should be strictly implemented so that polluted water is not disposed off directly into rivers and lakes. Water treatment plants should be installed in all industrial areas (Fig. 18.10). At our individual levels we should consciously save water and not waste it. **Reduce, reuse and recycle** should be our mantra !

Think of your daily routine – how can you save water?

We can think of creative ideas like reusing water used for washing and for other household tasks. For example,



Fig. 18.10 : Water treatment plant

water used for washing vegetables may be used to water plants in the garden.

Pollution is no longer a distant phenomenon. It is affecting the quality

of our daily lives. Unless we all realise our responsibility and start using environment-friendly processes, the very survival of our planet is in danger.

Do you know?

While brushing your teeth, leaving the tap running may waste several litres of water. A tap that drips once every second wastes a few thousand litres of water every year. Think about it !

KEYWORDS

AIR POLLUTION

CHEMICAL
CONTAMINATION

GLOBAL WARMING

GREENHOUSE
EFFECT

POLLUTANTS

POTABLE WATER

WATER POLLUTION

WHAT YOU HAVE LEARNT

- Air pollution is the contamination of air by impurities which may have a harmful impact on the living organisms and the non-living components.
- Pollutants are the substances which contaminate air and water.
- Carbon monoxide, nitrogen oxides, carbon dioxide, methane and sulphur dioxide are the major pollutants of air.
- Increasing levels of greenhouse gases like CO₂ are leading to global warming.
- Water pollution is the contamination of water by substances harmful to life.
- Sewage, agricultural chemicals and industrial waste are some of the major contaminants of water.
- Water which is purified and fit for drinking is known as potable water.
- Water is a precious natural resource. We must learn to conserve it.

Exercises

1. What are the different ways in which water gets contaminated ?
2. At an individual level, how can you help reduce air pollution?
3. Clear, transparent water is always fit for drinking. Comment.
4. You are a member of the municipal body of your town.
Make a list of measures that would help your town to ensure the supply of clean water to all its residents.
5. Explain the differences between pure air and polluted air.
6. Explain circumstances leading to acid rain. How does acid rain affect us?
7. Which of the following is not a greenhouse gas?
 - (a) Carbon dioxide
 - (b) Sulphur dioxide

- (c) Methane
- (d) Nitrogen
8. Describe the 'Green House Effect' in your own words.
 9. Prepare a brief speech on global warming. You have to deliver the speech in your class.
 10. Describe the threat to the beauty of the Taj Mahal.
 11. Why does the increased level of nutrients in the water affect the survival of aquatic organisms?

Extended Learning — Activities and Projects

1. In some cities, a pollution check has been made compulsory for vehicles. Visit a petrol pump in order to learn about the process of conducting a pollution check. You may systematically record your findings in the following areas:
 - Average number of vehicles checked per month.
 - Time taken to check each vehicle.
 - Pollutants checked for.
 - The process of testing.
 - Permissible levels of emission of various gases.
 - Measures taken if the emitted gases are above the permissible limits.
 - How frequently is a pollution check required ?
2. Conduct a survey in your school to investigate various environment related activities that have been undertaken. The class can divide itself into two groups, with each group looking at a different area. For example, one group can find out whether there is an environment club in the school. What are its objectives ? What is its calendar of events ? How can you become a member ?

If your school does not have such a club, you even think of starting one along with a few of your friends.
3. Organise a field visit to a river in or around your town with the help of your teachers.

Observations followed by discussion could focus on

- the history of the river.
 - cultural traditions.
 - role of the river in meeting the town's water needs.
 - pollution concerns.
 - sources of pollution.
 - effects of pollution on the people living by the riverside as well as those living far away.
4. Find out with the help of your teachers and the internet (if possible), whether there are any international agreements to control global warming. Which are the gases covered under these agreements?